

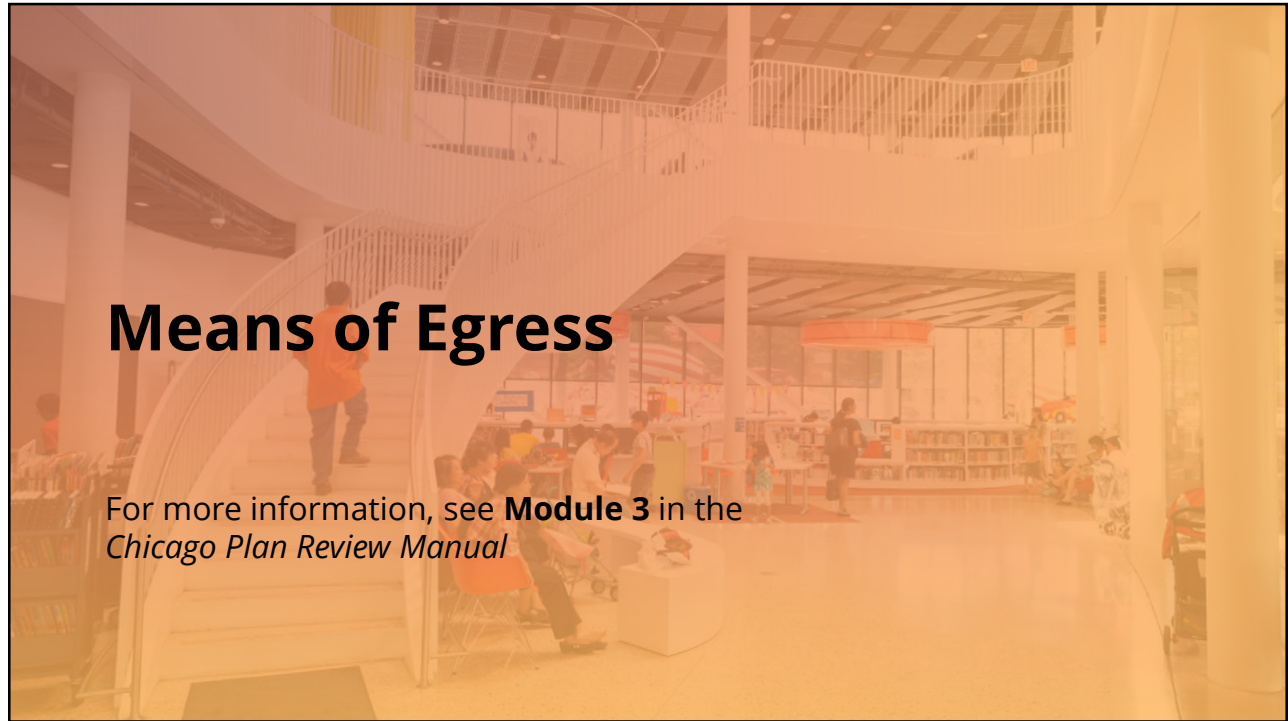

Morning Session 2: Egress and Fire-resistance Rated Construction

- ① Means of Egress
- ② Fire-resistance Rated Construction



CODE BOOK



Means of Egress

MEANS OF EGRESS. A continuous and unobstructed path of vertical and horizontal egress travel from any *occupiable space* in a *building* or *structure* to a *public way*.

A means of egress consists of three separate and distinct parts:

- the *exit access*,
- the *exit*, and
- the *exit discharge*.

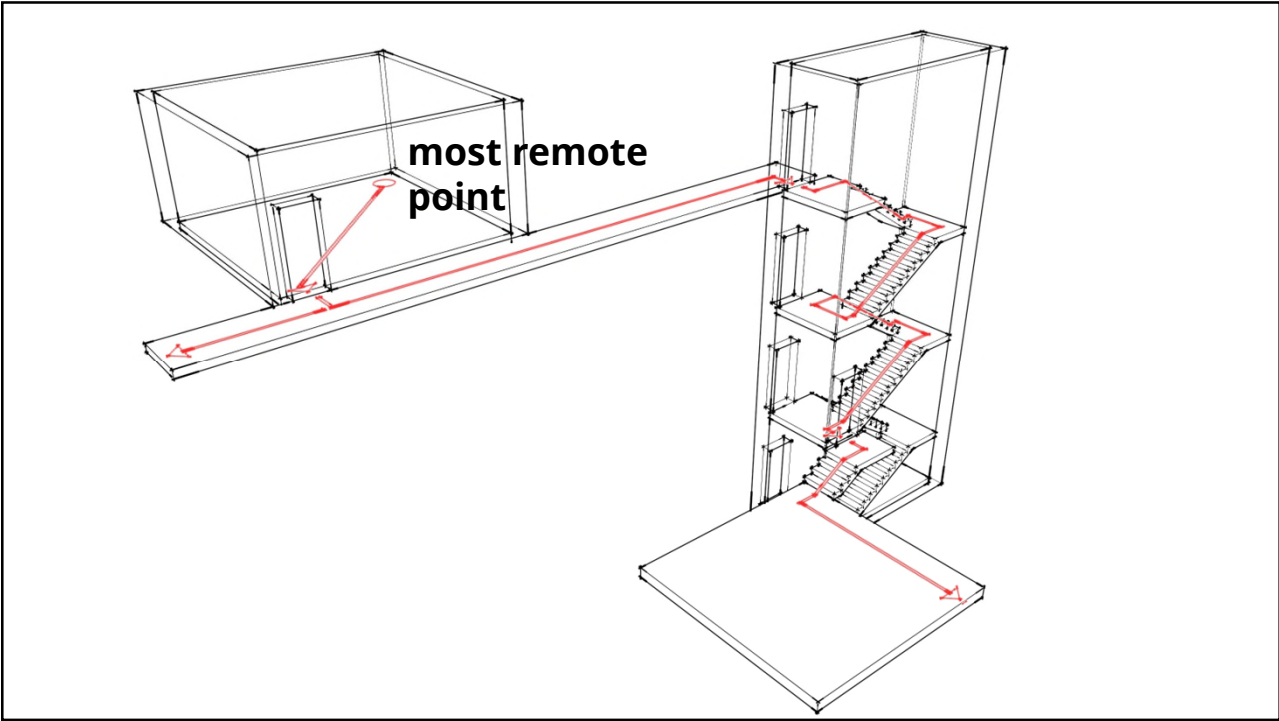
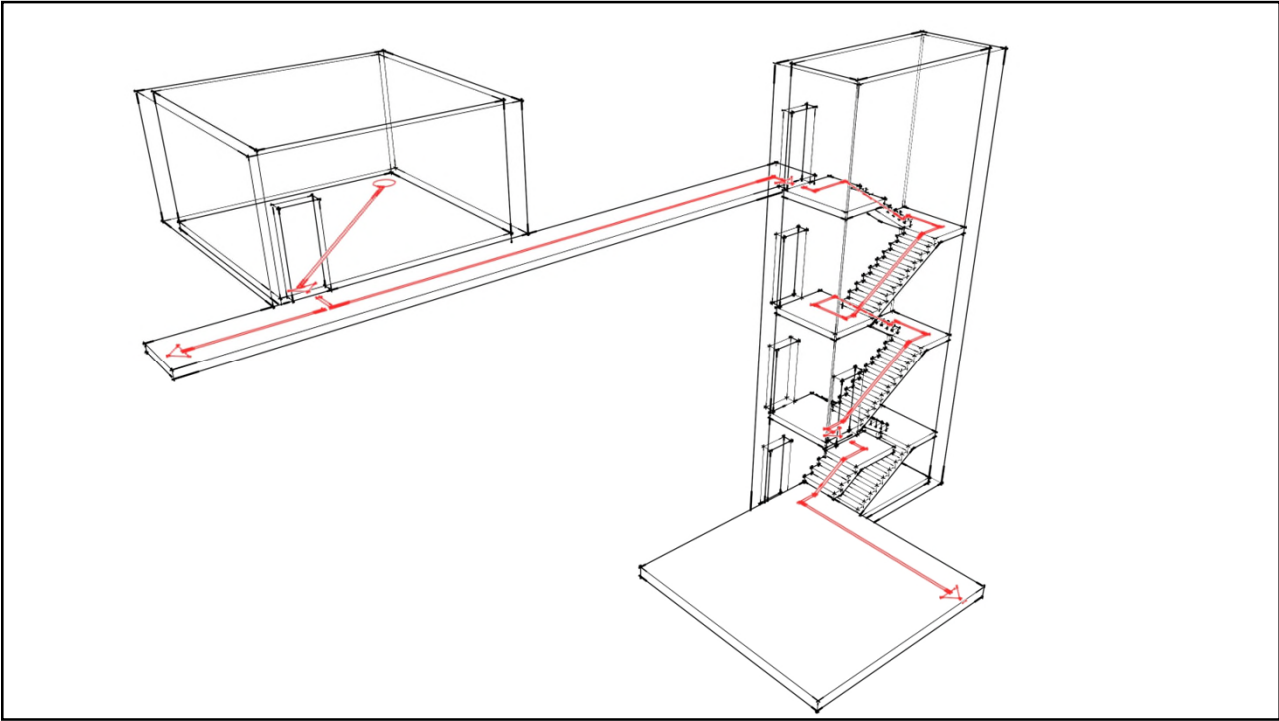

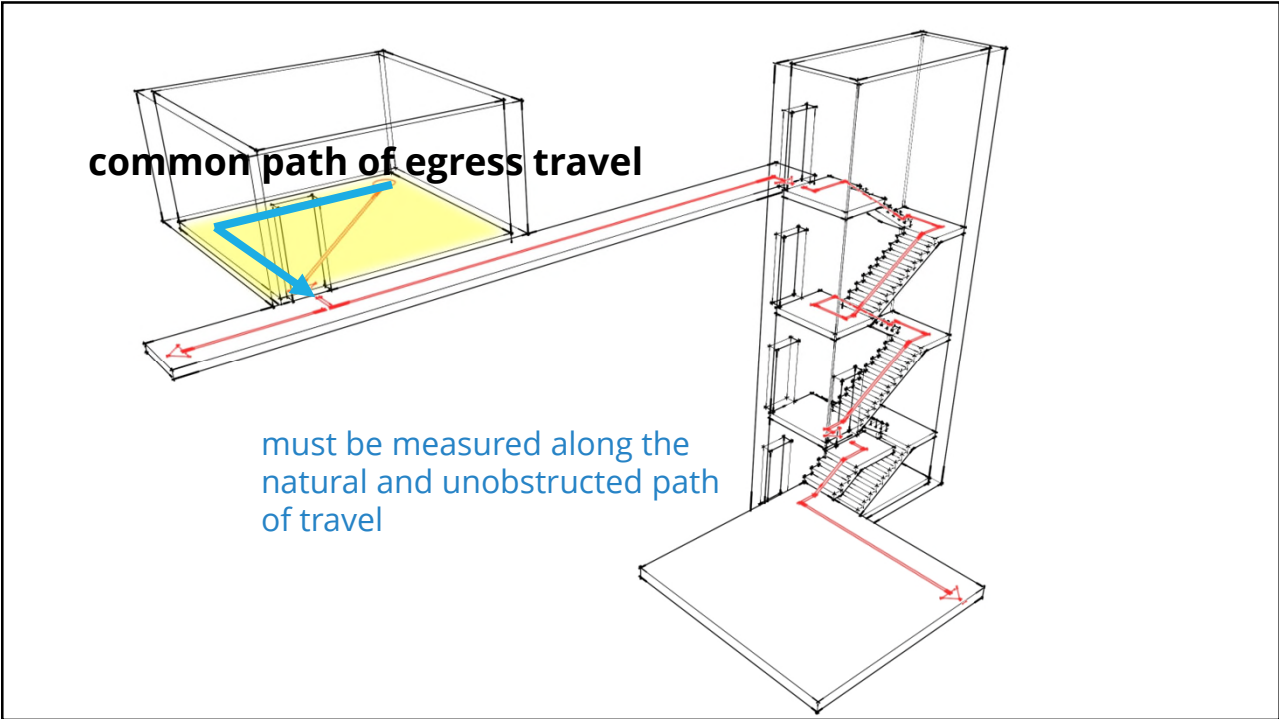
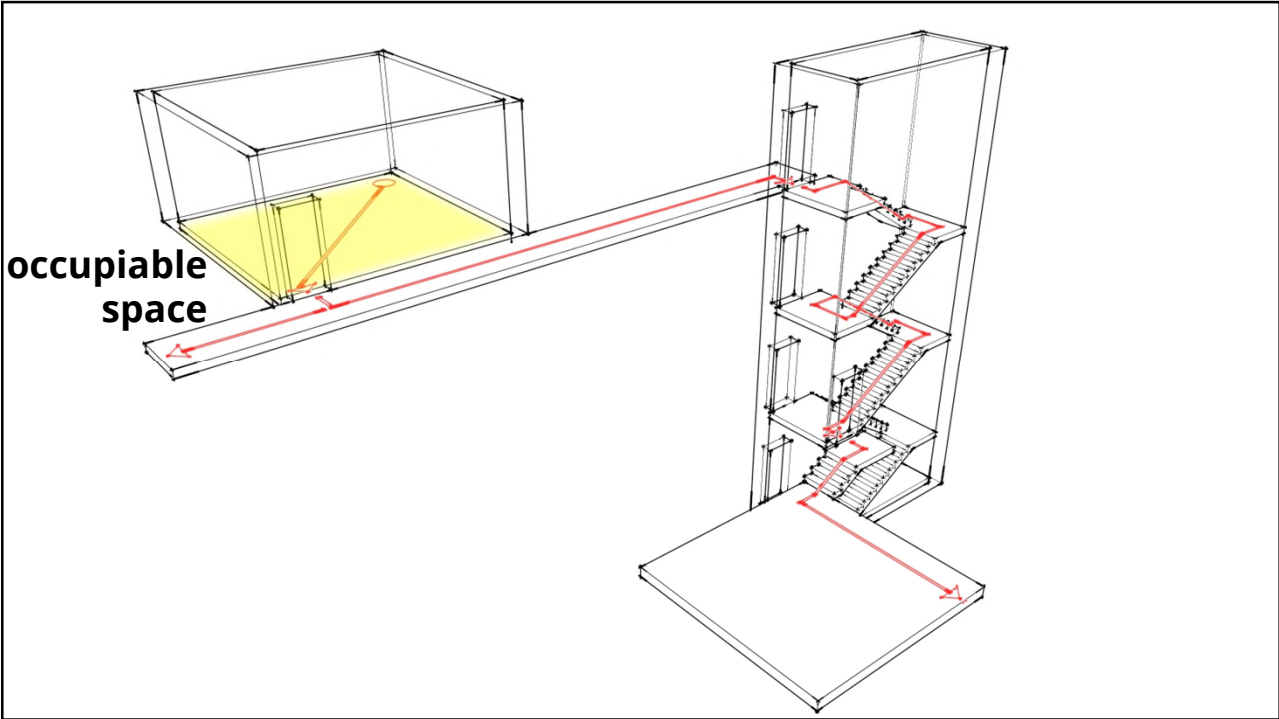

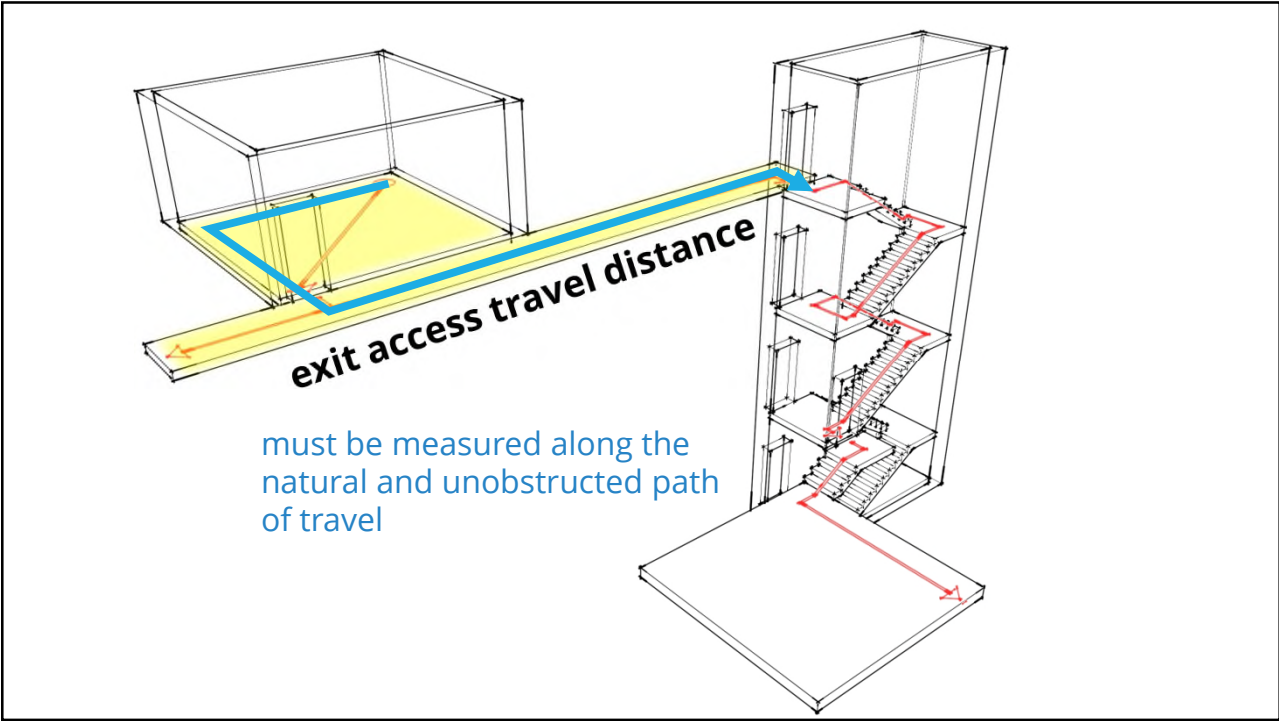
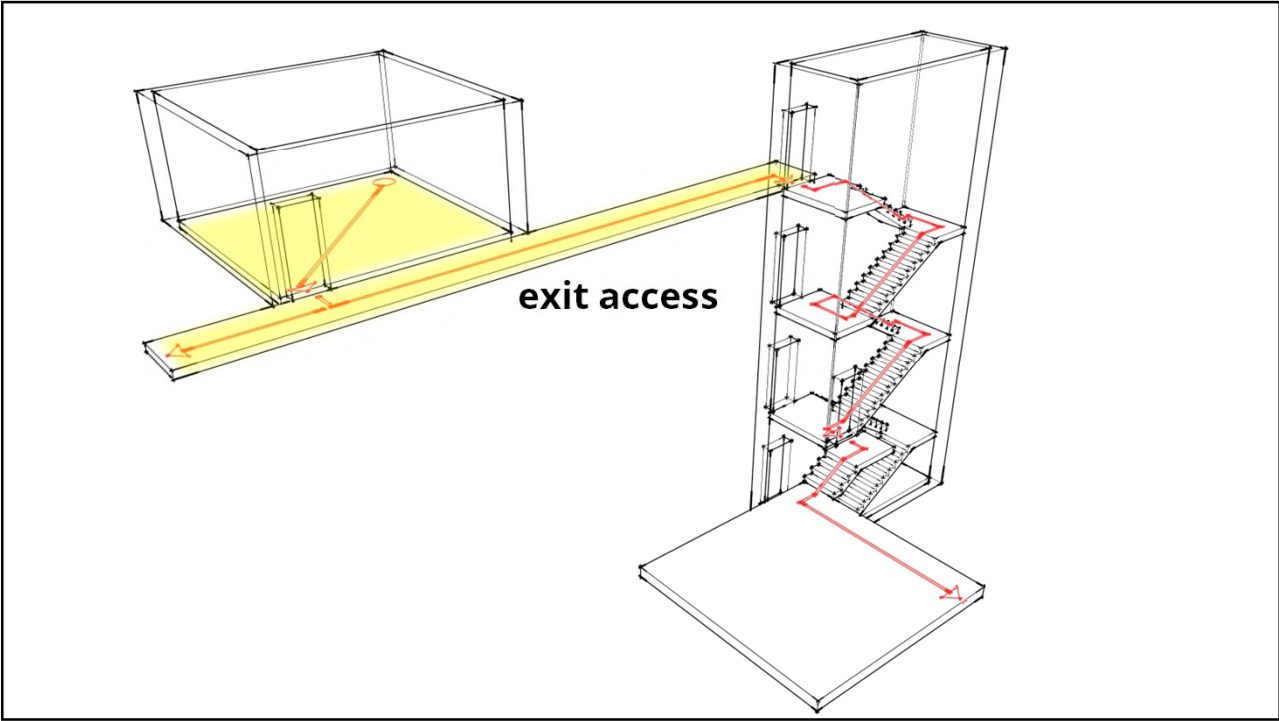

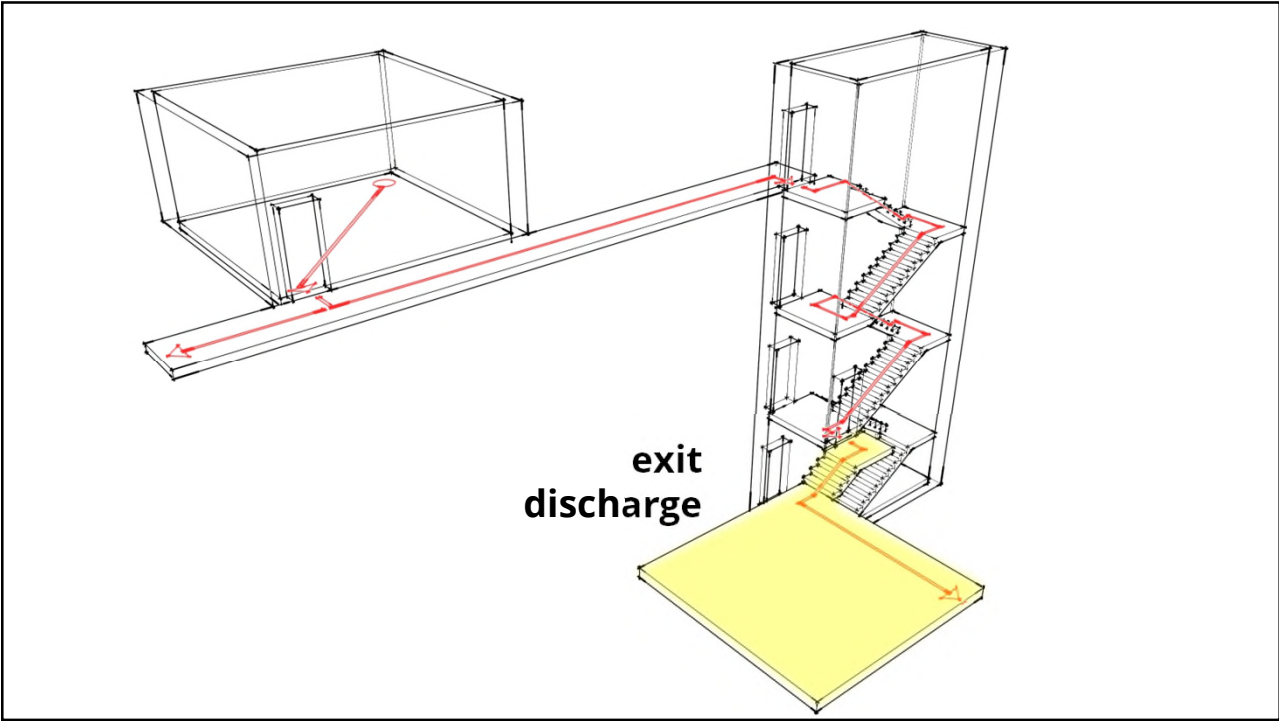
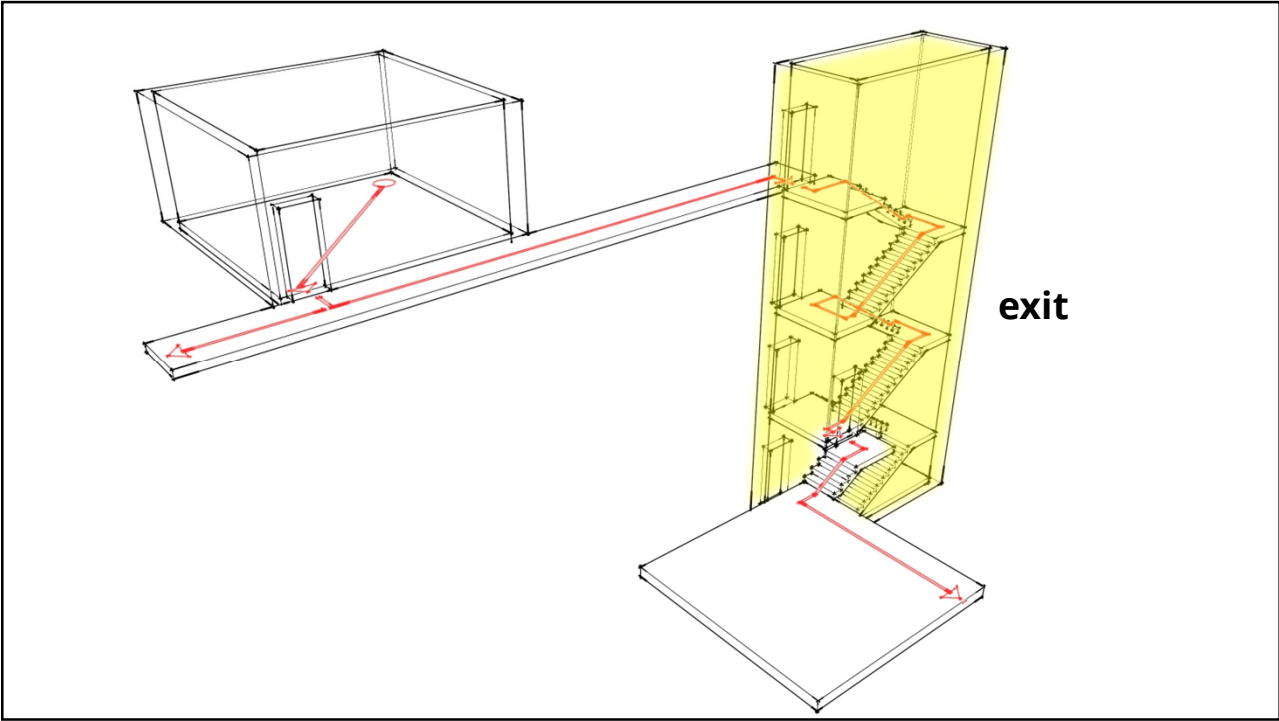

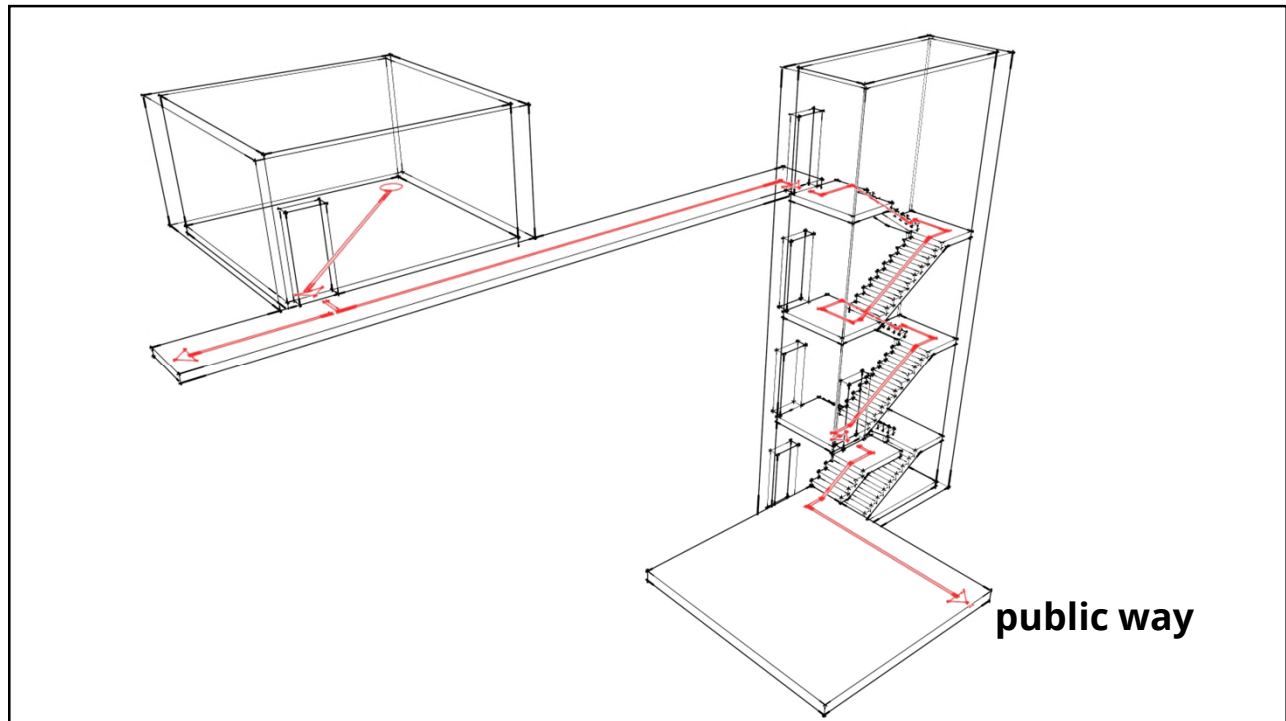

Determining Occupant Load

- Floor area factors in Table 1004.5
- Always safe to use gross floor area, but net floor area is allowed for some categories (see Sec. 203.5 for difference)
- Fixed seating (incl. benches, stools, booths) per Sec. 1004.6
- Include outdoor areas (limited exceptions)

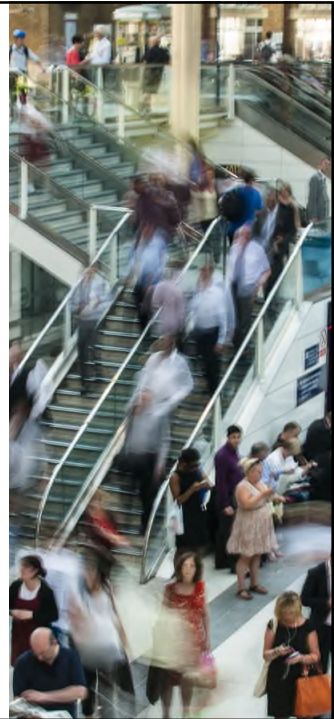

KEY CONCEPT



5 Steps to Determine Occupant Load

- 1 Categorize the function for each area without fixed seating using closest category in Table 1004.5
- 2 Identify the occupant load factor for each use/area. Note whether the factor is based on gross or net floor area.
- 3 Calculate the design occupant load using factors for open floor areas and for fixed seating per Sec. 1004.6.
- 4 Calculate combination loads at areas of convergence.
- 5 Determine the design occupant load.

FOR EXAMPLE



Restaurant Example (p. I-162)

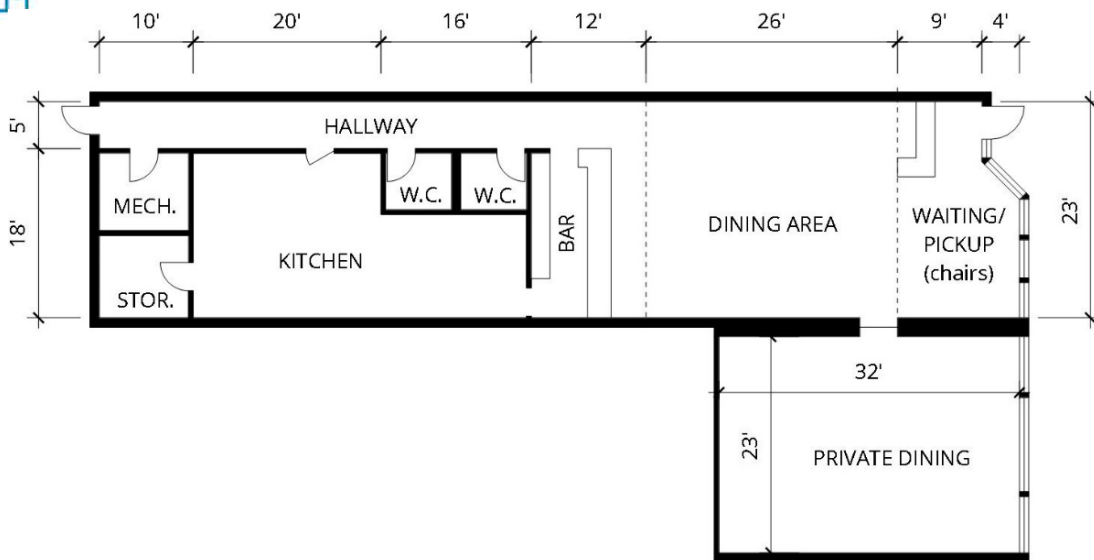

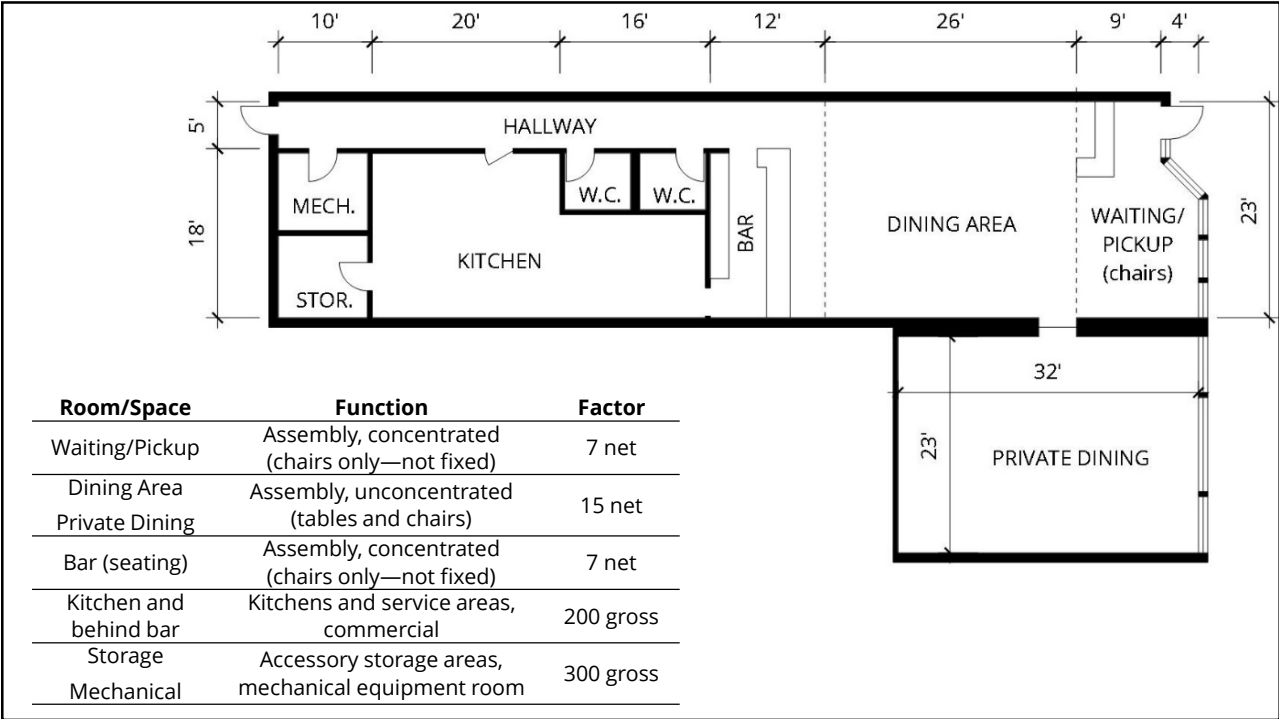
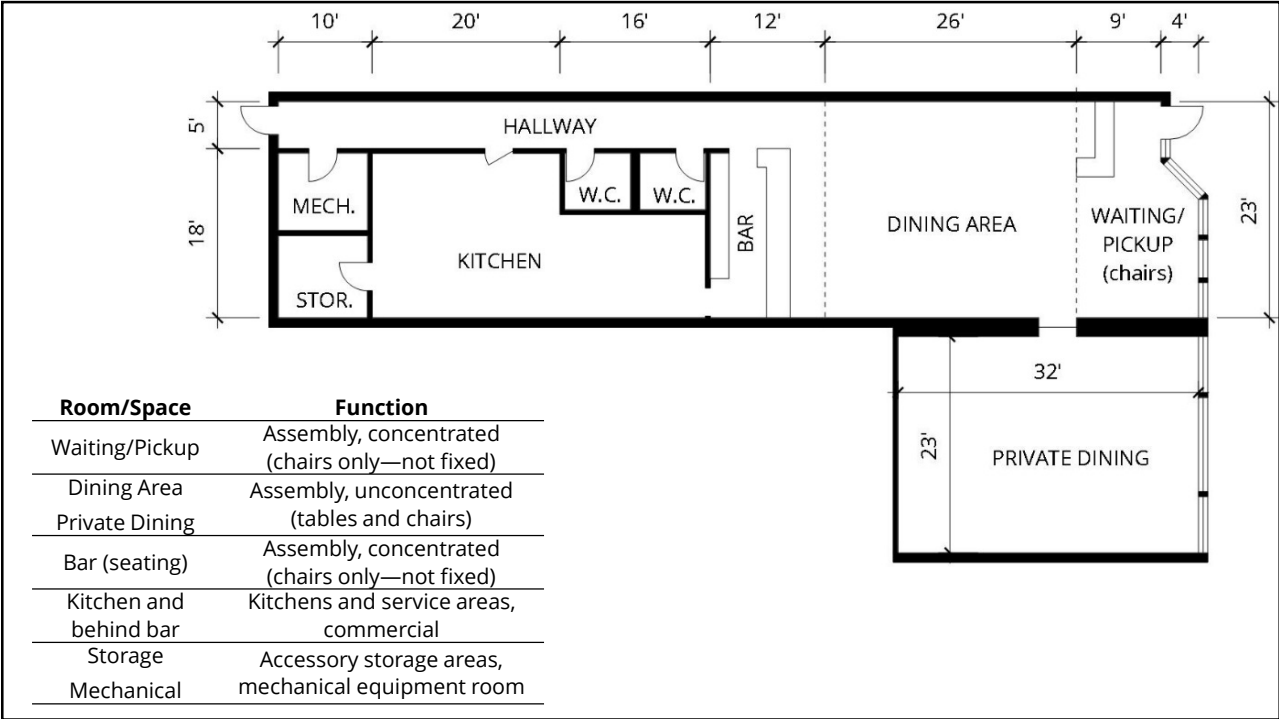

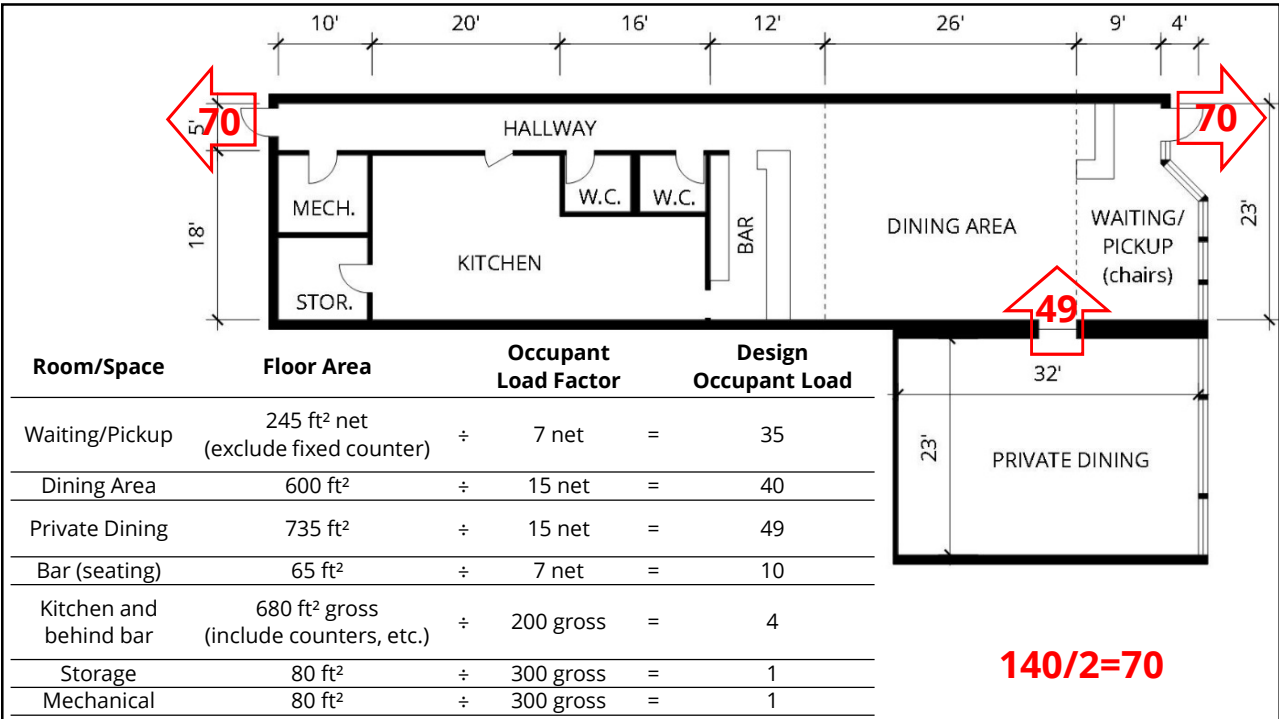
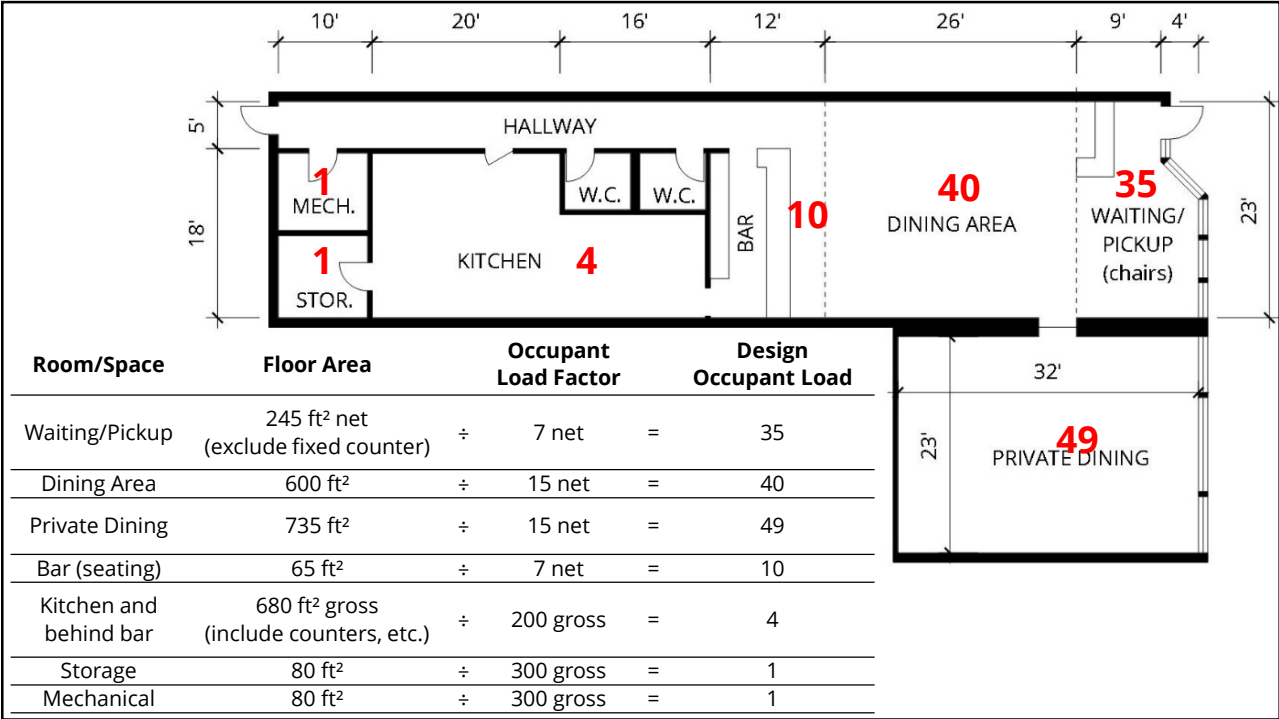

Check Number and Location of Exits / Access to Exits

- Check number of exits (or access to exits) provided / required from each story and occupiable rooftop.
- If two exits are required from the story, check that each room/space on that story has the required number of exits, based on occupant load, and access to the number of exits required for the story.



What not to do...

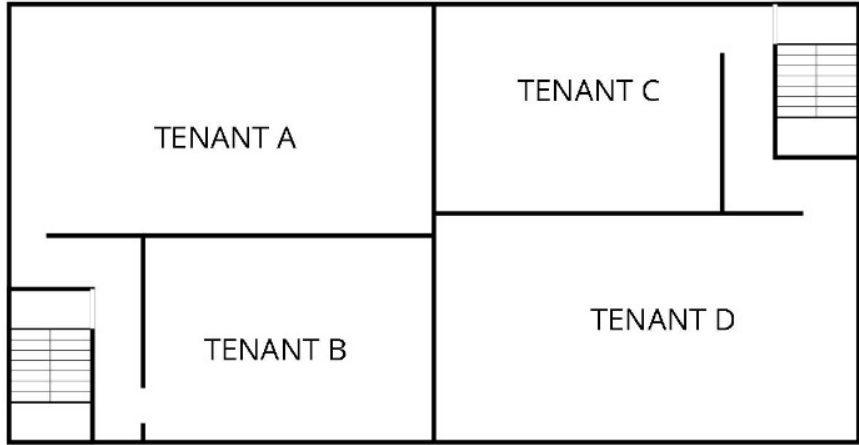

THIRD STORY ABOVE GRADE PLANE

Check Number and Location of Exits / Access to Exits (continued)

- Story with occupant load of 501 to 1,000 requires 3 exits or exit access stairways.
- Story with occupant load > 1,000 requires 4 exits or exit access stairways.
- Interlocking or scissor stairs are counted as one exit.
- Exit access stairways must connect to enclosed exits +/- 1 story in most occupancies.

Check Number and Location of Exits / Access to Exits (continued)

- Allowances for single exit from a story (residential) are in 1006.3.3 and are very similar to 13-160-050(c) through (o)
 - Chicago single-exit rules substituted for IBC/IRC requirements for egress windows (not required by CBC)
- Limited allowances for single exit from occupiable rooftops.
- Limited allowance for single exit from basement used for storage/mechanical up to 2,000 ft²
- One exit allowed from mech. penthouse because treated as part of story below

Check Number and Location of Exits / Access to Exits (continued)

- Number of exits from room/space determined by three factors:
 - Floor area over 4,000 ft² requires 2 exits
 - Occupant load exceeds limit in Table 1006.2.1
 - Common path of egress travel exceeds limit in Table 1006.2.1
- 3 exits are required for room or space with OL > 500, 4 if OL > 1,000
(Section 1006.2.1.1 missing from first printing of CBC-printing error)
- 2 exits may be required based on use: boiler and equipment rooms, electrical equipment rooms, etc.

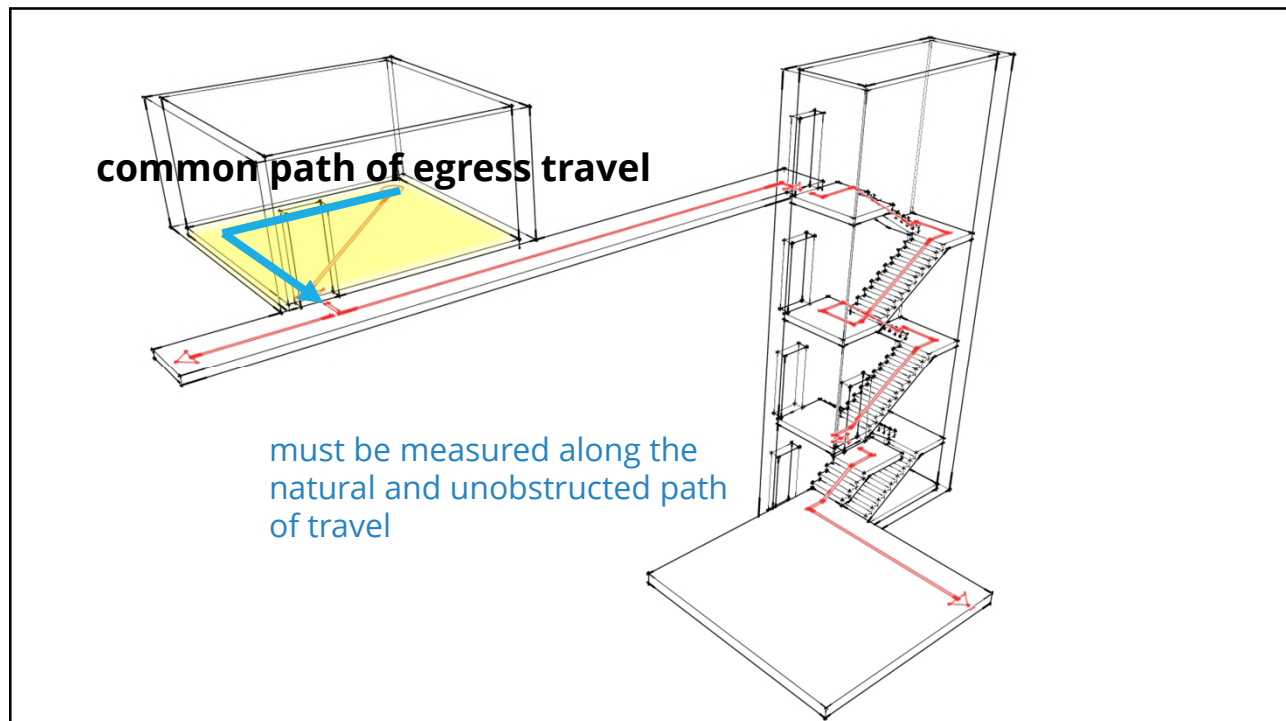

**TABLE 1006.2.1
SPACES WITH ONE EXIT OR EXIT ACCESS DOORWAY**

OCCUPANCY	MAXIMUM OCCUPANT LOAD OF SPACE	MAXIMUM COMMON PATH OF EGRESS TRAVEL DISTANCE (feet)	
		Without Sprinkler System (feet)	With Sprinkler System (feet)
A ^c , E	49	75	75 ^a
B, M	49	75	115 ^a
F	49	75	115 ^a
H-1, H-2, H-3	3	NP	25 ^b
H-4, H-5	10	NP	75 ^b
I-1, I-2 ^d , I-4	10	NP	75 ^a
I-3	10	NP	100 ^a
R-1	10 ^b	60	75 ^a
R-2	20 ^b	60	75 ^a
R-3 ^e , R-5 ^e	20 ^b	60	75 ^{a, g}
R-4 ^e	20	60	75 ^{a, g}
S ^f	29	75	115 ^a
U	49	75	75 ^a

For SI: 1 foot = 304.8 mm, 1 square foot = 0.0929 m².
NP = Not Permitted.

Check Number and Location of Exits / Access to Exits (continued)

- When a room, space, or story is required to have 2 or more means of egress, they must be separated from each other.
 - Fully sprinklered building: 1/3 diagonal
 - Other buildings: 1/2 diagonal

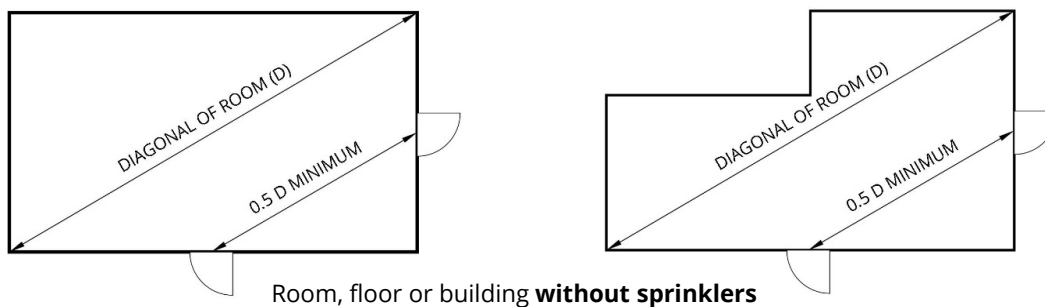

Check Number and Location of Exits / Access to Exits (continued)

Measurement Rules

- Separation distance to an exit or exit access doorway is measured to any point along the width of the doorway.
- Separation distance to an exit access stairway is measured to any point on the closest riser.
- Separation distance to an exit access ramp is measured to any point on the start of the ramp run.
- Where the path between the two exits for a story is a 1-hour fire-resistance-rated corridor, the separation distance may be measured along the shortest direct line of travel in the corridor.

Check Number and Location of Exits / Access to Exits (continued)

Exceptions to Mathematical Separation

- *Old rule:* two means of egress must be remote from one another to minimize the change of both being blocked by smoke/fire.
 - Group R-5 occupancies
 - Within dwelling units or sleeping units
 - Group B or M tenant spaces separated from other spaces by 1-hour rated construction, with ACAR approval
- Fully sprinklered Group R-2, with dead ends not exceeding 20', may reduce separation to 15'

Check Size and Capacity of Egress System

- Fractional inch/occupant factors replace units of exit width.
- Egress components also have minimum widths.

Capacity of Egress Components		
Component Type	NFPA 13 or 13R system throughout building	
	No	Yes ^a
Stairway	0.3 inch / occupant	0.2 inch / occupant
Indoor assembly seating aisles	See Section 1029.6.1	
Open air assembly seating aisles	See Section 1029.6.3	
Assembly aisle accessways	See Section 1029.13	
Other egress component (Doors, gates, etc.)	0.2 inch / occupant	0.15 inch / occupant

a. Use non-sprinklered factor for Group H and I-2 occupancies.

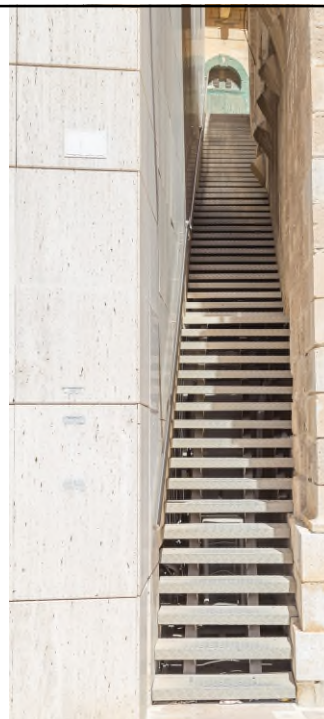

Check Size and Capacity of Egress System (continued)

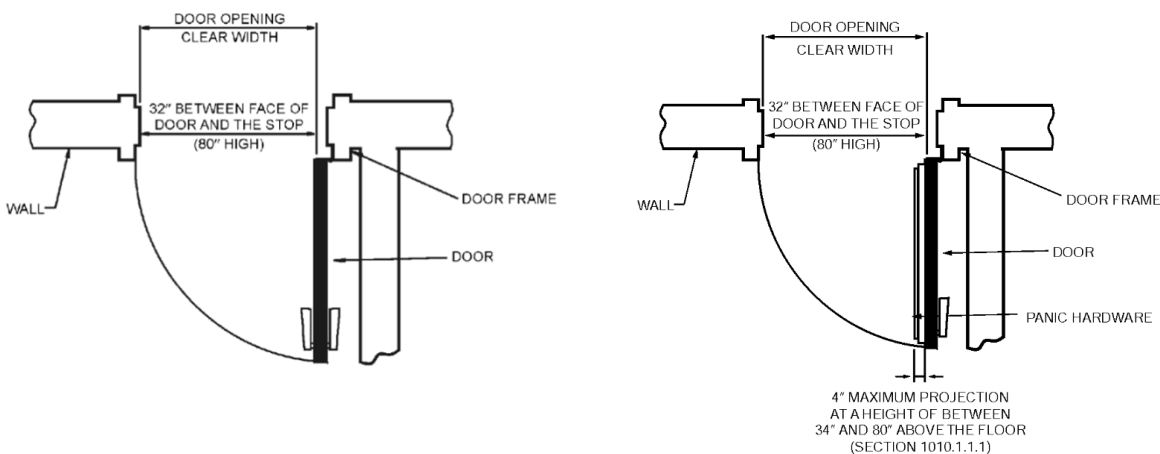

Check Size and Capacity of Egress System (continued)

Encroachment for Stairs, Ramps, Corridors:

- Handrails can project 4.5 inches
- Trim can project 1.5 inches
- Door hardware can project into corridors as allowed for doors

Distribution

- Where more than one exit or exit access is required, they must be sized so that the loss of any one does not reduce capacity by more than 50%

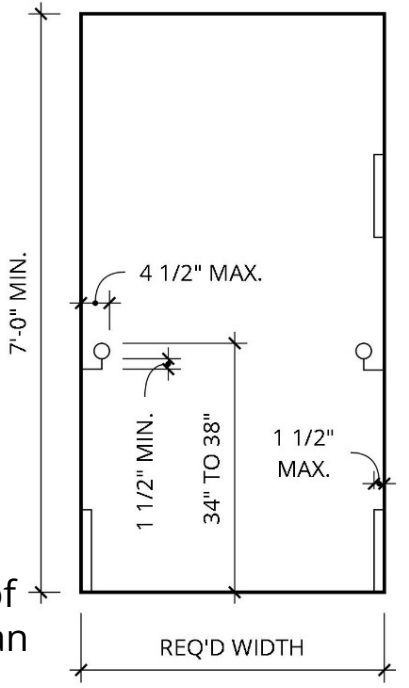

Exit Capacity Example (p. I-186)

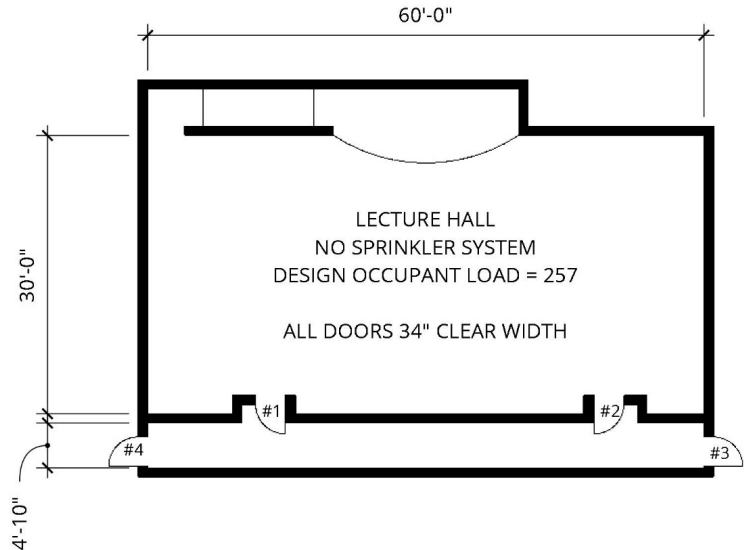

FOR EXAMPLE



Exit Capacity Example (continued)

- | | | |
|----|--|--------------------------------|
| 1. | Determine the occupancy of the building or space. | <u>Group A-3</u> |
| 2. | Determine the type of component(s) (stair, ramp, door, corridor, egress court). | <u>2 doors,
1 corridor</u> |
| 3. | Determine whether the building is equipped with a sprinkler system in accordance with the applicable standard. | <u>No</u> |
| 4. | Determine the design occupant load. | <u>257</u> |

FOR EXAMPLE



Exit Capacity Example (continued)

- 5. Compute the maximum capacity of the egress components.
 - a. Determine the clear width of each component.

Door #1 = 34"	Door #4 = 34"
Door #2 = 34"	Corridor = 58"
Door #3 = 34"	

FOR EXAMPLE



Exit Capacity Example (continued)

- b. Determine whether the components are sized to accommodate the design occupant load.

- i. Determine the egress width per occupant for each component.

**0.2 in /
occupant**

Door #1 = 34"

Door #4 = 34"

Door #2 = 34"

Corridor = 58"

Door #3 = 34"

FOR EXAMPLE



Exit Capacity Example (continued)

- ii. Divide the clear width(s) by the allowed egress width per occupant. Add the capacities of similar components together.

[Door #1 = 34" ÷ 0.2 = 170] +

[Door #2 = 34" ÷ 0.2 = 170] = 340

[Door #3 = 34" ÷ 0.2 = 170] +

[Door #4 = 34" ÷ 0.2 = 170] = 340

Corridor = 58" ÷ 0.2 = 290

FOR EXAMPLE



Exit Capacity Example (continued)

- 6. Compare the design occupant load with the lowest maximum capacity of the egress component(s).

Design occupant load = 257 ≤ 340 (capacity of doors)

Design occupant load = 257 ≤ 290 (capacity of corridor)

- 7. Determine compliance.
Do egress components satisfy the design occupant load?

Yes

FOR EXAMPLE



Exit Capacity Example (continued)

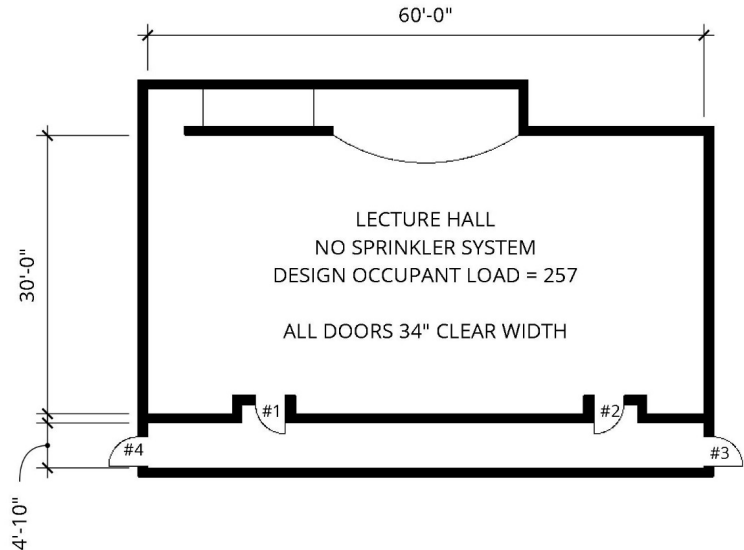

Check Exit Access Components

Exit access travel distance

- The distance from the most remote point of each room, area, or space to the entrance to the nearest exit.
- Measured along the natural, unobstructed path of horizontal and vertical egress travel.
- The length of exit access travel may not exceed the length specified in Table 1017.2.



Check Exit Access Components (continued)

**TABLE 1017.2
EXIT ACCESS TRAVEL DISTANCE^a**

OCCUPANCY	WITHOUT SPRINKLER SYSTEM (feet)	WITH SPRINKLER SYSTEM (feet)
A, E, F-1, M, R, S-1	200 ^c	250 ^b
I-1	Not Permitted	250 ^b
B	200	300 ^c
F-2, S-2, U	300	400 ^c
H-1	Not Permitted	75 ^d
H-2	Not Permitted	100 ^d
H-3	Not Permitted	150 ^d
H-4	Not Permitted	175 ^d
H-5	Not Permitted	200 ^c
I-2, I-3	Not Permitted	200 ^c
I-4	150	200 ^c

Check Exit Access Components (continued)

Egress through intervening spaces:

- Egress from a room or space to an exit may not pass through an adjoining room or space unless all the following conditions are met.
- Egress may not pass through a room that can be locked to prevent egress.
- Egress may not pass through a toilet room or bathroom.
- Egress from a sleeping area (bedroom) may not pass through another sleeping area (bedroom).
- Egress may not pass through a commercial kitchen, storage room, closet, or space used for similar purposes.
- Egress from a dwelling unit, sleeping unit, or tenant space may not pass through another dwelling unit, sleeping unit, or tenant space.

Check Exit Access Components (continued)

Exit access corridors:

- Required to have a fire-resistance rating in some occupancies (Table 1020.1)
- Minimum width varies by occupancy (Table 1020.2)
- Doors from occupiable spaces at any point in door swing may not reduce width to less than $\frac{3}{4}$ required width.
 - Does not apply to closet doors.
 - Does not apply within a dwelling unit.
- Dead end corridors limited by occupancy and sprinkler system
- Exit access corridors may not be used for air movement (with exceptions).

Check Exits and Exit Discharge Components

- Interior exit stairways (or ramps) provide a protected vertical path of egress travel, separated from other areas of the building by fire-resistance rated construction with limited openings and penetrations.
- Exit discharge is the portion between the enclosed exit and the public way.
 - Lobbies (where allowed)
 - Vestibules
 - Outdoors (on private property)

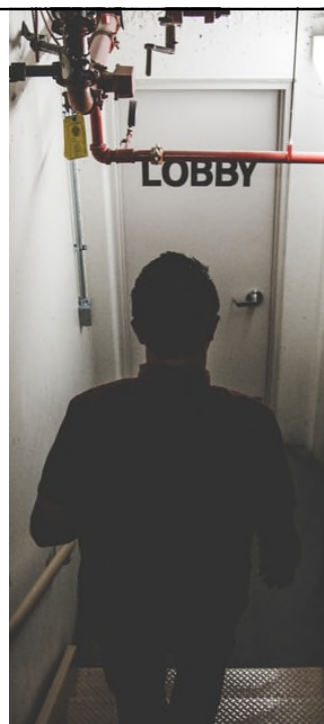

Exits and Exit Discharge Components (continued)

Interior Exit Enclosures

- Fire-resistance rated enclosure (fire barriers)
 - 1-hour if connecting 3 or fewer stories
 - 2-hour if connecting 4 or more stories
- Openings limited to those needed for access from normally-occupied spaces
 - No elevators, mechanical rooms, toilet rooms, utility access
- Penetrations into enclosure are prohibited, except as listed in Section 1023.5 and 1023.6

Exits and Exit Discharge Components (continued)

Exterior walls of exit enclosures

- Two options
 - Exterior wall is rated as required for exit enclosure and openings are limited
 - Adjoining exterior wall within 10 feet is 1-hour rated and openings have $\frac{3}{4}$ -hour protectives.

Doors

- Opening protectives required per Table 716.1(2)

Exits and Exit Discharge Components (continued)

Discharge identification

- The level of exit discharge must be clearly identified for users of the exit stairway/ramp.
- Directional exit signs should be used within stair at discharge level.
- If it continues below the level of exit discharge, a barrier should be provided.

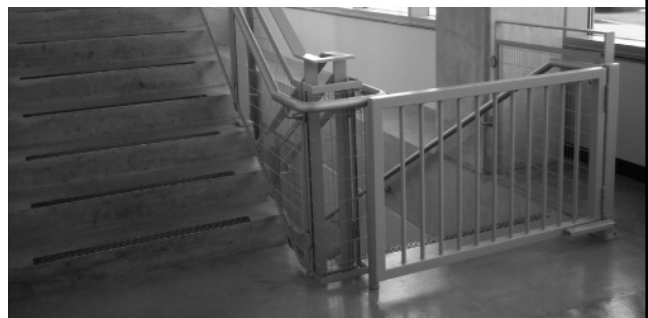

Exits and Exit Discharge Components (continued)

Exit passageways (typ. horizontal transfer between two exit stairs)

- Construction, openings and penetrations limited similar to requirements for exit stair enclosures.

Horizontal exits

- Limited to 50% of required exit capacity.
- 2-hour fire-resistance rated construction.
- Continuous from wall to wall, and 2-hour floor/ceiling required if not vertically continuous.
- Refuge areas must be provided 3 ft²/occupant.

Exits and Exit Discharge Components (continued)

Exterior exit stairways and ramps

- Not allowed for Group I-2 or levels (stories or occupiable rooftops) more than 45 feet above grade at discharge of stair
- Limited to 50% of required exit capacity
- Protection and separation required
 - Exceptions for residential porches up to 4 stories



Exits and Exit Discharge Components (continued)

Exit discharge

- Chicago allows 100% of exits to discharge through a lobby per Sec. 1028.1, Exception 4 (fully sprinklered building)
- In non-sprinklered building 50% of exits may pass through lobby if lobby level is sprinklered
- Discharge through vestibules
- Discharge directly to outside

Exits and Exit Discharge Components (continued)

Egress courts and exterior travel

- Minimum width and capacity must be maintained in outside areas.
- Minimum width of egress courts is 44" (except 36" for R-3, R-5)
- Walls within 10' of egress court must be fire-resistance rated and have opening protectives
- Egress should discharge to public way
 - Dispersal area allowed when access to public way not possible (rare)

Check General Egress Requirements

- Doors
 - Locks and latches
- Stairs
- Handrails
- Guards
- Exit signs
- Means of egress illumination
- Assembly



General Egress Requirements (continued)

Egress doors

- Minimum clear width: 32" (within non-accessible dwelling units, 28")
- Maximum width/leave: 48" nominal
- Minimum height: 80" (within dwelling unit 78")
- Must be pivoted or side-hinged (limited exceptions)
- Must swing in direction of travel where OL > 49
- Opening force for doors and gates, other than fire doors

General Egress Requirements (continued)

Locks and latches

- Egress doors must be readily openable without key or special knowledge.
- Delayed egress locks allowed in Group B, F, I, M, R, S and U occupancies (limited allowances for Group A occupancies)
 - 15 sec. delay max
 - Must swing in direction of egress
 - Only one delayed lock on egress path
- Panic hardware required for Group A, E occupancies with OL > 49.

General Egress Requirements (continued)

Stairways

- 44" wide min. (36" if OL < 50)
- Measured in clear at narrowest point, excluding allowed projections
- Handrail required on both sides.
- Guard will be required at center of stairways under new code.
- Landings depth must equal width of stair, but max. 48"
- Minimum width will be measured with radius when path of egress turns

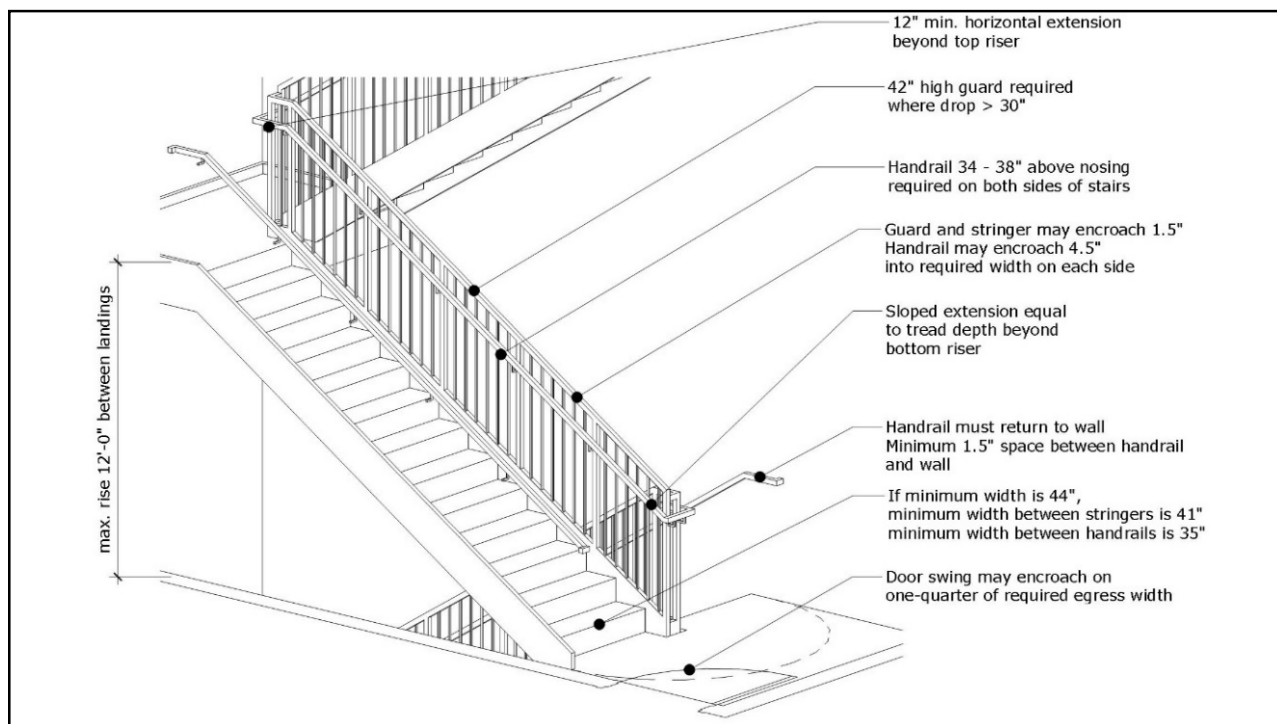

General Egress Requirements (continued)

Stairways

- Minimum headroom 7'-0"
- Maximum rise between landings: 12'-0" (all occupancies)
 - 12'-7" within dwelling units, Group R-5
- Door swinging into stairway, in any position, may not reduce clear width to less than $\frac{3}{4}$ required width

General Egress Requirements (continued)

Treads and risers

- Tread depth: 11" min.
- Riser height: 7" max.
- Solid risers required.
- Consult code for circular and spiral stairs.
- In Group R-5 and within dwelling units, stairs allowed to be steeper and use Chicago-style winders

General Egress Requirements (continued)

Handrails

- Handrails required on both sides of stairs
 - Limited exceptions
- Stairs wider than 60" require intermediate handrail
- Ramps with rise > 6" require handrails on both sides
- Handrails must meet dimensional requirements for graspability
 - Type II handrails allowed within dwelling units and Group R-5
- Handrails must be continuous and return to a wall or guard
- Handrail height: 34" to 38" above nosing

General Egress Requirements (continued)

Guards

- Required at open side of walking surfaces more than 30" above floor or grade within 36" horizontally
 - Surface that is 12" or less in depth, measured perpendicular to face of guard is not a walking surface, nor are planting beds or countertops at least 34" high. Benches are a walking surface.
- Common sense exceptions for loading platforms, transit platforms, stages, etc.
- 42" high, except 36" allowed in Group R-5 up to 3 stories above grade and within dwelling units.
- 4" sphere rule applies to guards up to 36" high

General Egress Requirements (continued)

Exit signs

- Remain as in pre-2019 Chicago Code
- "EXIT" and "STAIR" required.
- Must be illuminated, red lettering on translucent white background.
- Arrows required, no chevrons.
- Required in all rooms that require more than one exit or exit access.
- Must be readily visible and at least every 100' along corridor.

General Egress Requirements (continued)

Means of egress illumination

- Required for all portions of means of egress, including exit discharge (exterior)
- 1 fc at walking surface
- May be dimmed in Group A during exhibits or performances

Emergency lighting

- Rooms required to have 2 exits
- Corridors and exits
- Equipment rooms
- Public restrooms > 300 ft²

Fire-resistance Rated Construction

For more information, see **Module 4** in the *Chicago Plan Review Manual*

KEY CONCEPT



Fire Safety Requirements

- Code includes interrelated strategies to protect people and property from fire and other hazards
 - Fire-resistance-rated and smoke resistant construction
 - Interior finishes
 - Fire protection and life safety systems
 - Means of egress
- Chapter 7 deals with “passive” fire resistance



Fire Safety Requirements (continued)

- Structural fire endurance
- Limit spread of fire from building to building
- Limit spread of fire and smoke from space to space

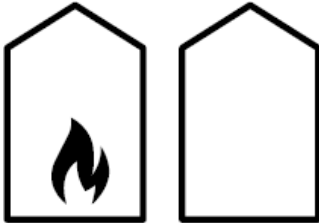

Prevent Conflagration

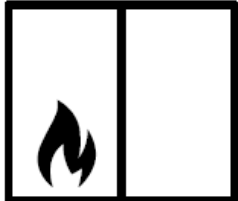

Compartmentation

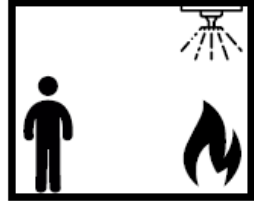

“Active” Systems

KEY CONCEPT



Fire-resistance Rated Construction

- Chapter 7 provides requirements for:
 - Structural members
 - Walls and partitions
 - Floors
 - Roofs
 - Opening protectives
 - Penetrations

Note: marking fire-resistance rated walls in accessible concealed spaces and equipment rooms required by Sec. 703.7.



KEY CONCEPT



Ratings

- **Fire-resistance rating** – Relative duration a building, element, component, or assembly is expected to maintain the ability to confine a fire, perform a given structural function, or both, as determined by testing data or calculations derived from testing data.
- **Fire protection rating** – Relative duration that an opening protective (window, door, fire shutter, etc.) is expected to maintain the ability to confine a fire, as determined by testing data.



KEY CONCEPT



Multiple Use Fire Assemblies

- Assemblies that serve multiple purposes must comply with all fire-resistive requirements that are applicable for each purpose. For example:
 - A wall may be a load-bearing wall (required to have a fire-resistance rating based on construction type) and must comply with Section 704.1.
 - An incidental use separation (required to have a fire-resistance rating by Section 509) must be a fire barrier and comply with Section 707.
 - A corridor wall (required to have a fire-resistance rating by Section 1020) must be a fire partition and comply with Section 708.

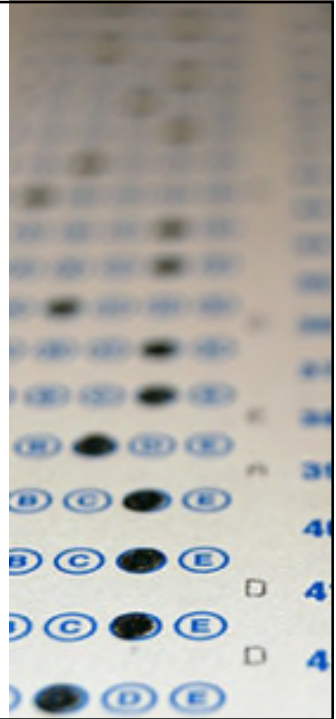

Exterior Walls

- Exterior walls are required to be fire-resistance rated based on both construction type (if load bearing) and fire-separation distance.
- Exterior surfaces with a slope less than 60° from horizontal, such as windowsills and the top surface of parapets, must meet requirements for roofs.

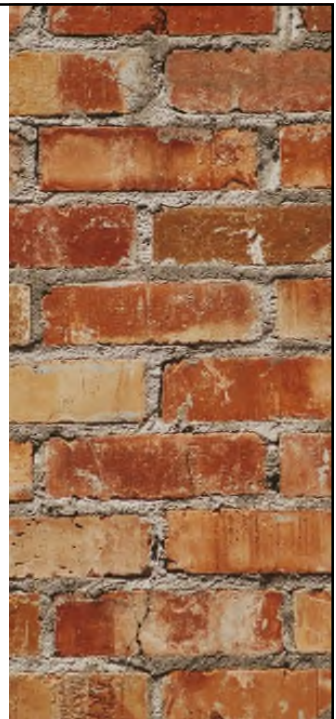
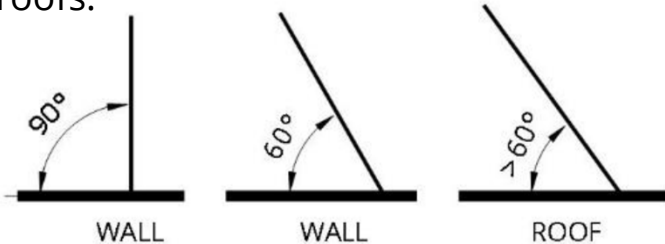

KEY CONCEPT



Fire Separation Distance

- The horizontal distance measured from the building face or element to one of the following:
 1. The closest *abutting property line*.
 2. The far boundary of a *public way* adjoining the *lot*.
 3. An imaginary line between two *buildings* on the same *lot*.The distance shall be measured at right angles from the face of a wall or edge of a building element.
- FSD is used to determine the required characteristics of exterior walls, openings in exterior walls, projections from exterior walls, and some features of occupiable rooftops.

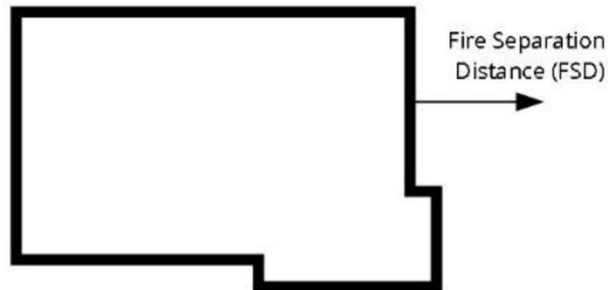

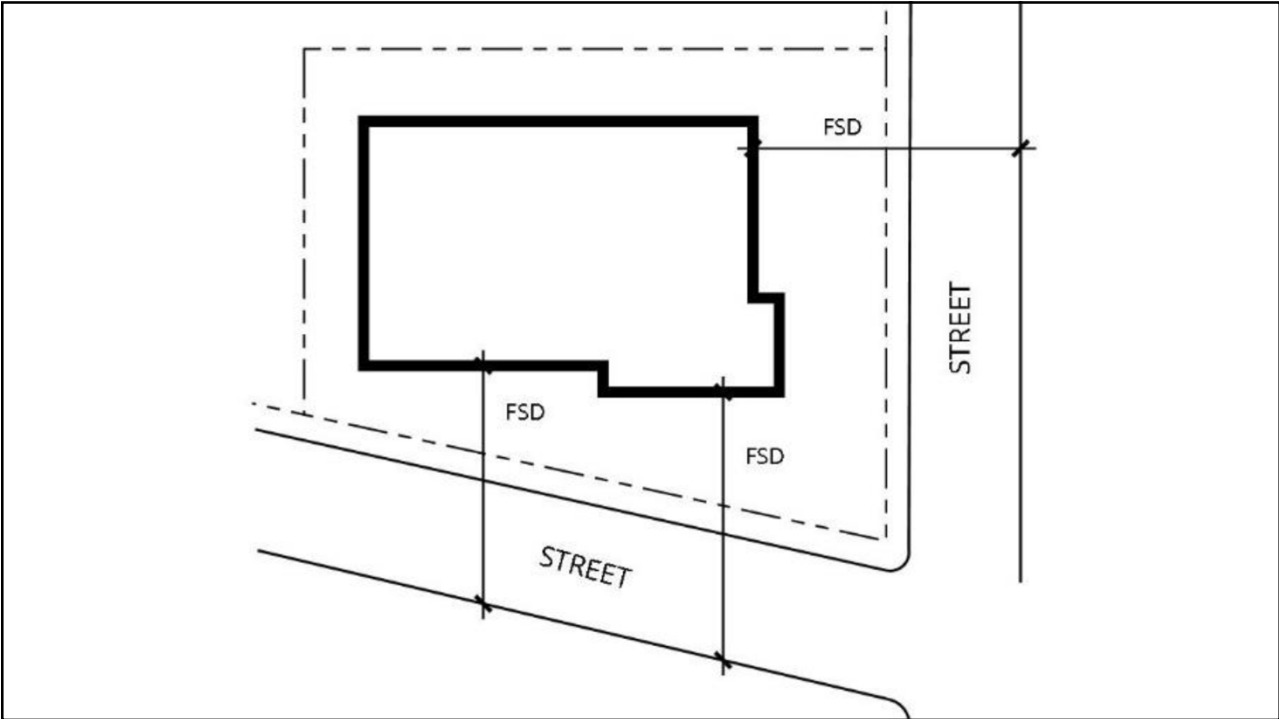
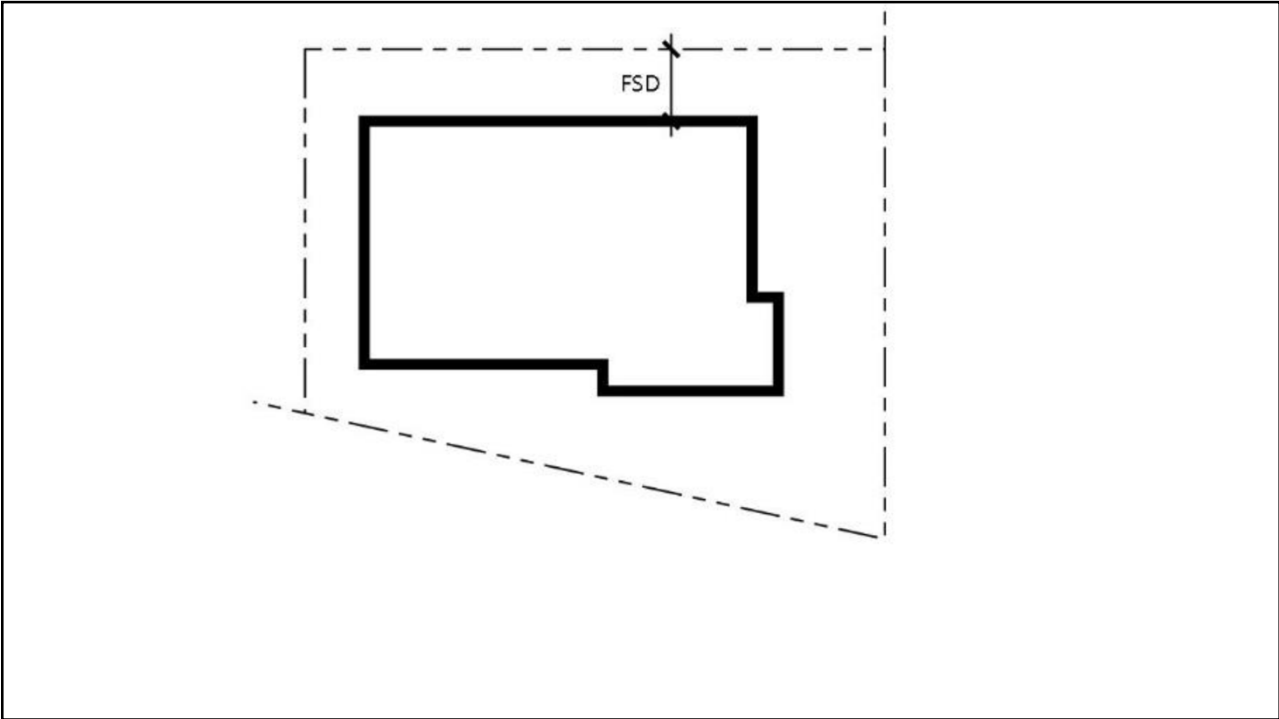

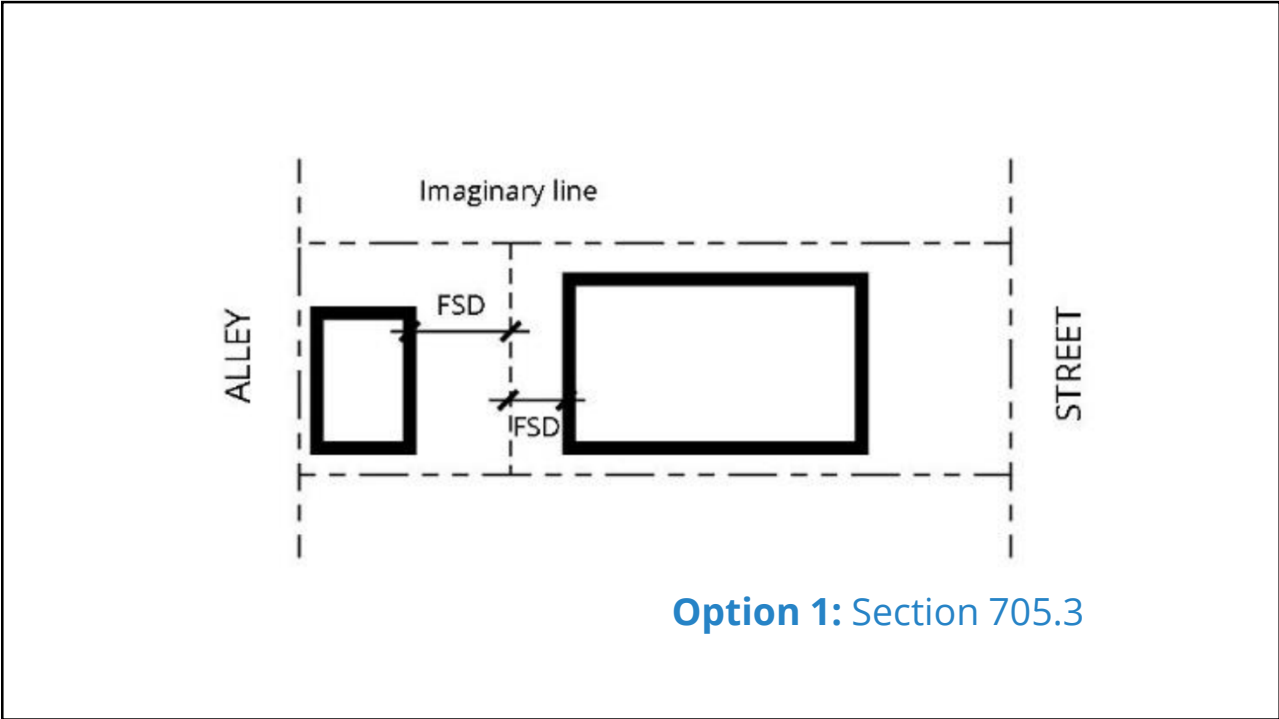

Easements

- Legal right to use another’s land for a specified purpose, either temporarily or permanently
- Easements may be used for fire separation distance or to establish yards for natural light and ventilation
- Easements must be permanent, shown on survey, and verified through ACAR process



Exterior Wall Requirements

- Materials
- Fire-resistance Rating
- Opening Protectives
- Ducts and Air Transfer Openings
- Parapets
- Joints



Exterior Wall Requirements (continued)

- Fire-resistance rating for nonbearing walls per Table 602 (fire separation distance)
- Fire-resistance rating for bearing walls—stricter of Table 601 (construction type) or 602 (fire separation distance)
- If FSD ≥ 10 ft, fire-resistance rating required from interior only

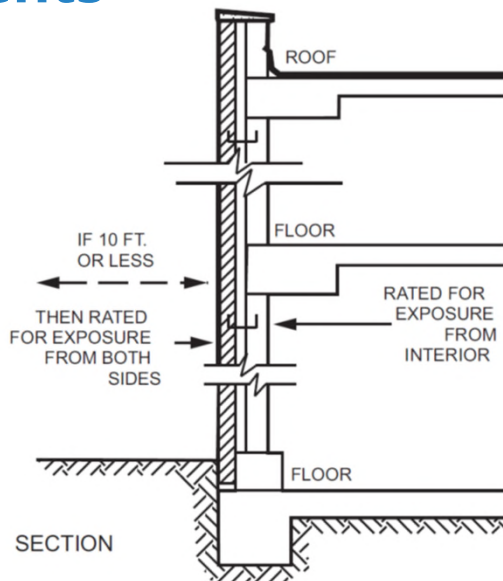

Exterior Wall Requirements (continued)

- Area of protected and unprotected openings per Tables 705.8(2) (residential buildings up to 4 stories) and 705.8(1) (all other buildings)
- Requirement is applied to each wall and each story.
- Where both protected and unprotected openings are used, sum of ratios of actual to allowable area must not exceed 1.

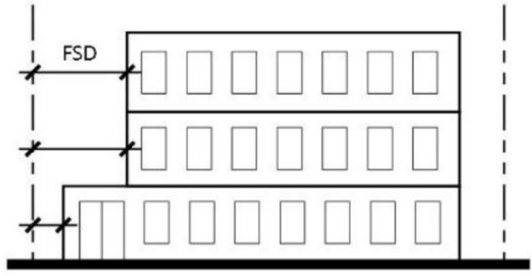

Max. Area of Openings

NOTE: Different rules for residential buildings up to 4 stories

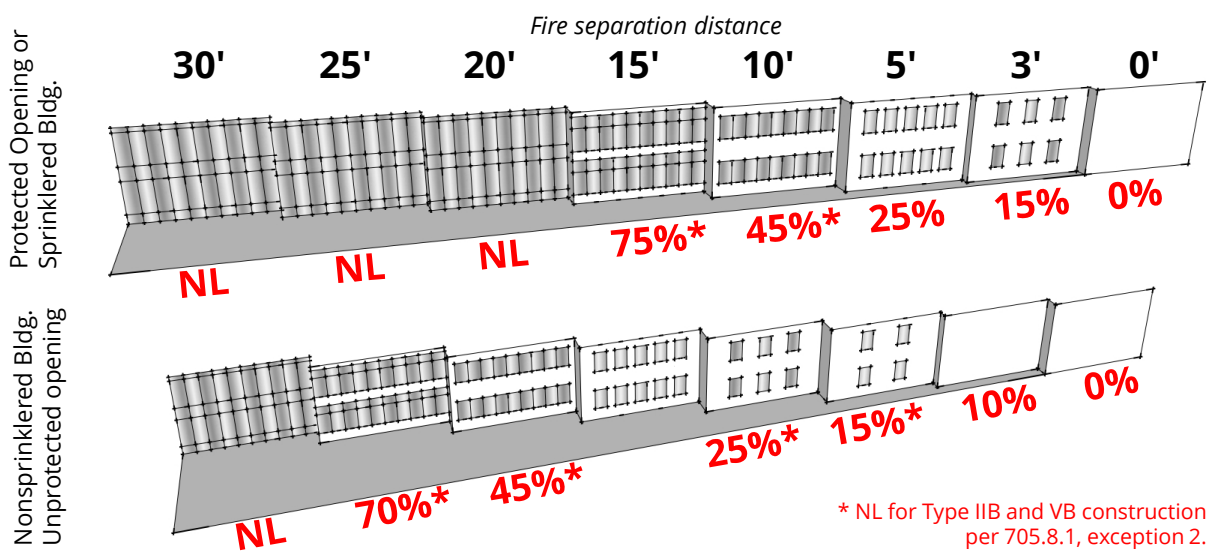

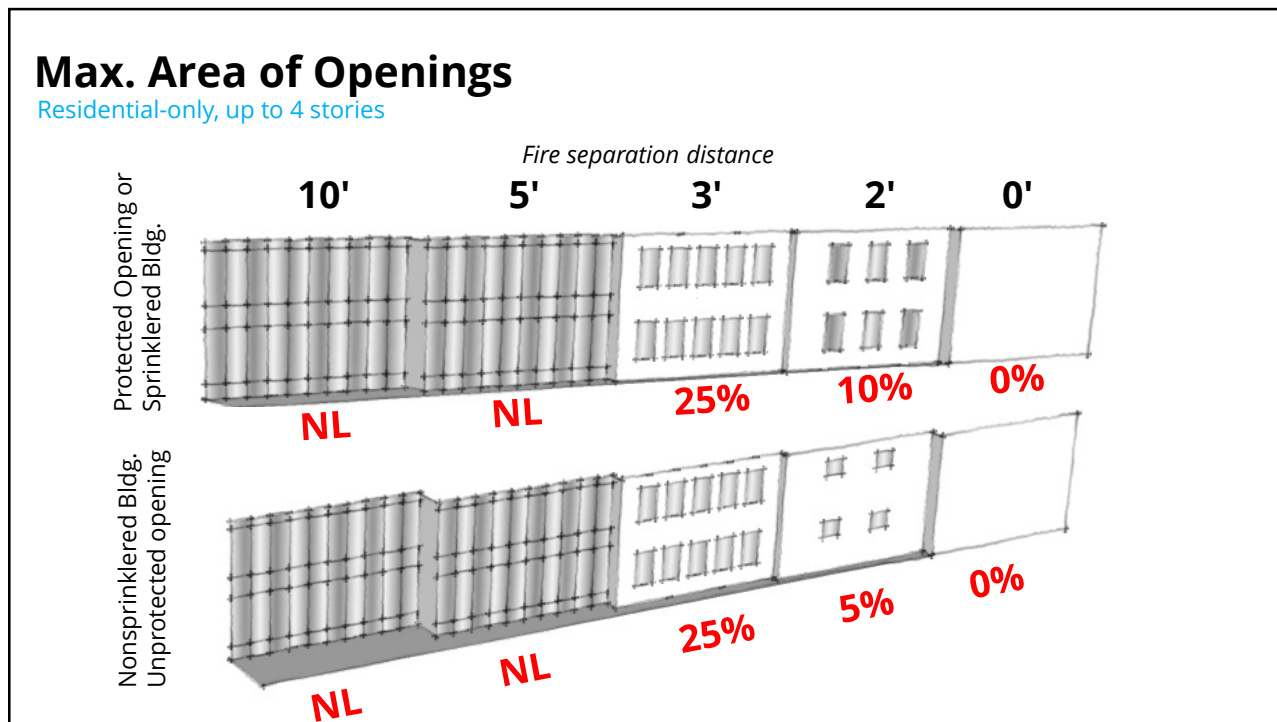

Exterior Wall Requirements (continued)

- When ducts and air transfer openings penetrate an exterior wall, they must be protected, unless exception applies.
 - Exception for foundation vents, residential kitchen and clothes dryer exhaust.
- 30" parapets are required, unless exception applies.
 - 5 exceptions, including FSD, building type/area, and rated roof construction
- Materials used to protect joints (such as expansion joints) must have a fire-resistance rating, but area doesn't count toward area of openings.

Exterior Wall Requirements (continued)

- Area of protected and unprotected openings per Tables 705.8(2) (residential buildings up to 4 stories) and 705.8(1) (all other buildings)
- Requirement is applied to each wall and each story.
- Where both protected and unprotected openings are used, sum of ratios of actual to allowable area must not exceed 1.

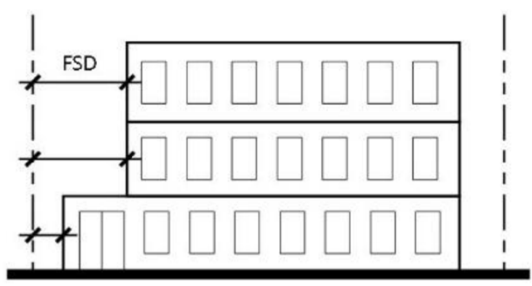

Exterior Wall Activity (p. II-24)

- Determine the required fire-resistance rating for each wall of the fully-sprinklered single-story Type IIB department store shown:

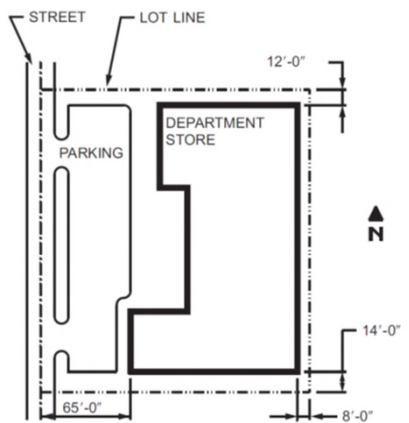

	North	East	South	West
Fire separation distance				
Bearing wall				
Nonbearing wall				
Area of Openings				



Exterior Wall Activity (answers)

- Determine the required fire-resistance rating for each wall of the fully-sprinklered single-story Type IIB department store shown:

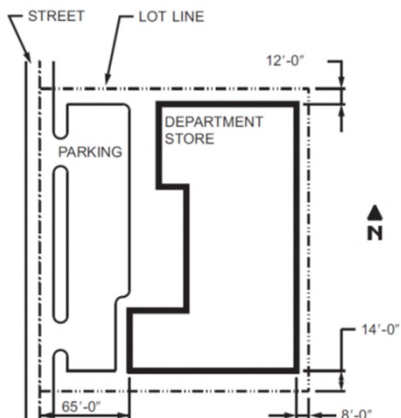

	North	East	South	West
Fire separation distance	12 ft	8 ft	14 ft	65+ ft
Bearing wall	0/NC	1/NC	0/NC	0/NC
Nonbearing wall	0/NC	1/NC	0/NC	0/NC
Area of openings	UL	25%	UL	UL



Exterior Wall Projections

- Chicago-specific definitions for “deck,” “porch,” and “exterior balcony”
- Also include: gutters/downspouts, bay windows, cornices
- Check separation distance (24” min.)
- Check materials
 - Table 705.2.1 for any construction type
 - Table 705.2.2 for Type III, IV or V construction
- Check % perimeter coverage



FOR EXAMPLE



Exterior Wall Projections

**TABLE 705.2.1
PROJECTIONS FROM WALLS OF ANY TYPE OF CONSTRUCTION***

Type of Projection	MATERIAL TYPE	Fire Separation Distance (feet) ^b			
		0 to less than 3	3 to less than 5	5 to less than 10	10 or greater
Cornices, eave overhangs, bay windows, oriel windows and similar decorative projections on <i>buildings</i> not exceeding 40 feet in <i>building height</i>	U	No	Yes	Yes	Yes
	P	Yes	Yes	Yes	Yes
Cornices, eave overhangs, bay windows, oriel windows and similar decorative projections on <i>buildings</i> greater than 40 feet in <i>building height</i>	U	No	No	No	No
	P	No	No	No	Yes
	PNC	Yes	Yes	Yes	Yes
Gutters and downspouts on buildings not exceeding 40 feet in <i>building height</i>	U	No	Yes	Yes	Yes
	UNC	Yes	Yes	Yes	Yes
Gutters and downspouts on buildings greater than 40 feet in <i>building height</i>	U	No	No	No	No
	UNC	Yes	Yes	Yes	Yes
<i>Exterior balconies</i> , each not exceeding 100 square feet in area, on <i>buildings</i> not exceeding 55 feet in <i>building height</i>	U	No	Yes	Yes	Yes
	UNC	Yes	Yes	Yes	Yes
<i>Exterior balconies</i> , each not exceeding 100 square feet in area, on <i>build</i>	U	No	No	No	No

FOR EXAMPLE



Exterior Wall Projections

**TABLE 705.2.1
PROJECTIONS FROM WALLS OF ANY TYPE OF CONSTRUCTION***

Type of Projection	MATERIAL TYPE	Fire Separation Distance (feet) ^b			
		0 to less than 3	3 to less than 5	5 to less than 10	10 or greater
Cornices, eave overhangs, bay windows, oriel windows and similar decorative projections on <i>buildings</i> not exceeding 40 feet in <i>building height</i>	U	No	Yes	Yes	Yes
	P	Yes	Yes	Yes	Yes
Cornices, eave overhangs, bay windows, oriel windows and similar decorative projections on <i>buildings</i> greater than 40 feet in <i>building height</i>	U	No	No	No	No
	P	No	No	No	Yes
	PNC	Yes	Yes	Yes	Yes
Gutters and downspouts on buildings not exceeding 40 feet in <i>building height</i>	U	No	Yes	Yes	Yes
	UNC	Yes	Yes	Yes	Yes
Gutters and downspouts on buildings greater than 40 feet in <i>building height</i>	U	No	No	No	No
	UNC	Yes	Yes	Yes	Yes
<i>Exterior balconies</i> , each not exceeding 100 square feet in area, on <i>buildings</i> not exceeding 55 feet in <i>building height</i>	U	No	Yes	Yes	Yes
	UNC	Yes	Yes	Yes	Yes
<i>Exterior balconies</i> , each not exceeding 100 square feet in area, on <i>build</i>	U	No	No	No	No



Fire Walls

- Fire walls divide a single structure into multiple buildings
- Protected openings in fire walls are limited
- Protected openings in fire walls on a property line (party walls) are extremely limited
- Combustible members framing into fire walls must be surrounded by 4" of noncombustible material
- CBC requires **4-hour rating**, but allows horizontal transfer with 4-hour supporting structure below

Fire Barriers

- Fire barriers must begin at the floor and extend to the floor or roof deck above.
- Where there is a concealed space above a ceiling (including a ceiling that is part of a rated floor-ceiling assembly), the fire barrier must continue through the above-ceiling space.
- In combustible construction, fireblocking must be installed at every floor level if the fire barrier contains hollow vertical spaces.
- All construction supporting a fire barrier must have a fire-resistance rating at least equal to that required for the fire barrier.

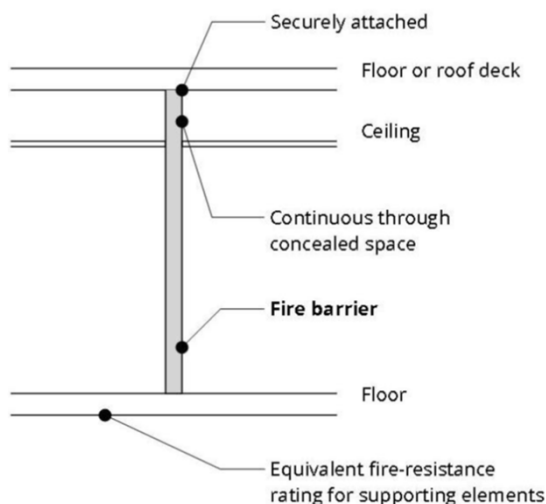

Fire Barriers (continued)

- Most fire-resistance-rated walls are required to be fire barriers:
 - Mixed-occupancy separations (Sec. 508.4)
 - Incidental use separations (Sec. 509)
 - Fire area separations (Ch. 9; Table 707.3.10)
 - Exit enclosures (Sec. 707.3.3, 1023.2)
- Hourly rating based on purpose.
- If multi-purpose, highest requirement.

Fire Partitions

- Fire partitions may be used to separate apartments or guest rooms in an apartment building or hotel. Fire partitions may also be used to separate a corridor from adjacent areas of the building in some occupancies.
- Minimum 1-hour fire-resistance rated construction.
- Must extend from the floor assembly to either the floor or roof sheathing above or to a fire-resistance-rated floor/ceiling or roof/ceiling assembly.

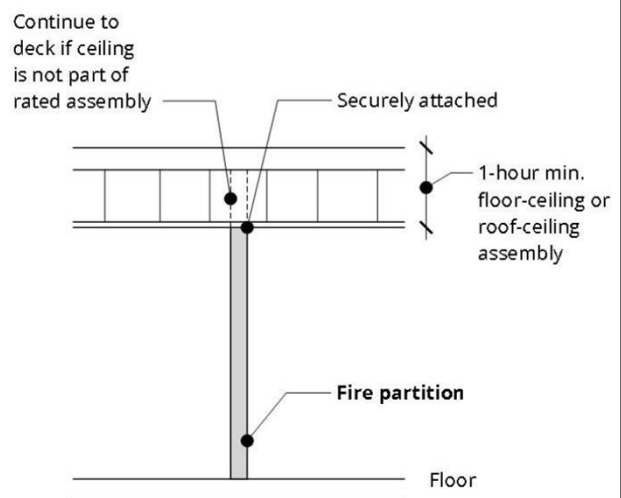

Smoke Barriers

- Smoke barriers are occasionally required by the code to resist the passage of smoke from one area to another. Smoke barriers will almost always also be required to have a 1-hour rating.
- In most cases, a smoke barrier is an enhanced form of fire barrier.
- Smoke barriers are required for:
 - Underground buildings (Sec. 405)
 - Group I-1, Condition 2
 - Groups I-2 and I-3
 - Ambulatory care facilities
 - Areas of refuge for accessible means of egress

Structural Members and Bearing Walls

- Fire-resistance rating may be required for:
 - Primary structural frame
 - Bearing walls
 - Structural members supporting fire-resistance-rated horizontal assemblies
- Fire-resistance design for structural members and interior bearing walls (not required as part of another fire-resistance rated assembly) does not require opening, joint, or penetration protection.

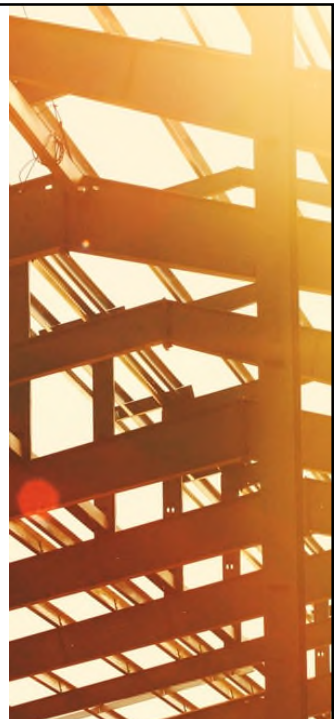



Structural Members and Bearing Walls—Example

- Type IIA construction requires 1-hour horizontal assemblies for floors and roofs as well as for the primary structural frame and bearing walls.
- If a two-story Type IIA building includes a horizontal exit on the second story, and the fire barrier does not extend to the first story, a 2-hour fire-resistance-rated floor is required by Section 1026.2.
- The primary structural frame and/or bearing wall structure supporting this floor must also have a 2-hour fire-resistance rating per Section 704.1.

Vertical Openings and Shaft Enclosures

- Vertical openings connecting 2 or more stories must be enclosed with fire-resistance rated construction or comply with one of the special provisions in Sec. 712.
- Shaft enclosures must have a 1-hour rating, or 2-hour rating if connecting more than 3 stories.





Vertical Openings and Shaft Enclosures

- Vertical openings connecting 2 or more stories must be enclosed with fire-resistance rated construction or comply with one of the special provisions in Sec. 712.
- Shaft enclosures must have a 1-hour rating, or 2-hour rating if connecting more than 3 stories.
- 1-hour shaft allowed to enclose noncombustible pipes, conduit, or iron, steel or aluminum ducts with floor penetration up to 9 ft²/story, any number of stories



Basement Construction

- Basements that exceed maximum areas must be subdivided with fire barriers into 40,000 ft² (80,000 ft² in fully-sprinklered building.)
- Basements with a floor level more than 60' below the lowest level of exit discharge must be subdivided into smoke compartments.
- In Type III or V buildings with 3 or more stories above grade, basement columns and bearing walls must be NC or HT.
- Buildings with multiple basements require Type IA construction below first story above grade.
- Floor construction over basements must have a min. 1-hour fire resistance rating (exception for R-5). [\(605.4\)](#)

Floor Construction

- Rated floor/ceiling assemblies must meet the strictest rating required by:
 - Construction type
 - Occupancy separation
 - Fire area separation
 - Incidental use separation
- Exception for bottom membrane of floor/ceiling assembly over unusable space.
- All construction supporting floor/ceiling assembly must have same minimum rating.

Roof Construction

- Roofs must have required fire-resistance rating.
 - No rating required for Type IIB, IIIB, or VB construction
 - Residential buildings ≤ 4 stories may be 30 min. ([Table 601, note h](#))
- Roofs must have required fire-resistance rating.
- Exception for top membrane of floor/ceiling assembly below unusable attic space.
- Roof assemblies must be continuous.
 - Skylights allowed. ([711.3.2](#))

Penetration Protection

- Protection required when pipes, conduit, ducts, etc. penetrate a fire-resistance rated assembly.
- Different rules for horizontal and vertical assemblies.
- Different rules for membrane penetrations and through penetrations.
- Different rules for air transfer openings.
- Helpful chart on p. II-86 of *Manual*.
- **Penetrations of exit enclosures r!**

KEY CONCEPT



Recap

- Exterior Walls
- Exterior Wall Projections
- Fire Walls
- Fire Barriers
- Fire Partitions
- Smoke Barriers
- Structural Members and Bearing Walls
- Vertical Openings and Shaft Enclosures
- Basement Construction
- Floor Construction
- Roof Construction
- Penetration Protection

CODE BOOK



For More Information . . .

Chicago Building Code

- **705, Ch. 14** Exterior Walls
- **705.2** Exterior Wall Projections
- **706** Fire Walls
- **707** Fire Barriers
- **708** Fire Partitions
- **709** Smoke Barriers
- **704** Structural Members and Bearing Walls
- **712, 713** Vertical Openings and Shaft Enclosures
- **605, 711** Basement Construction
- **711** Floor Construction
- **711, Ch. 15** Roof Construction
- **714, 715, 717** Penetration Protection

REFERENCE



For More Information . . .

Chicago Plan Review Manual

- **4.1** Exterior Walls (also **6.1**)
- **4.2** Exterior Wall Projections
- **4.3** Fire Walls
- **4.4** Fire Barriers
- **4.5** Fire Partitions
- **4.6** Smoke Barriers
- **4.7** Structural Members and Bearing Walls
- **4.8** Vertical Openings and Shaft Enclosures
- **4.9** Basement Construction
- **4.10** Floor Construction
- **4.11** Roof Construction (also **6.2**)
- **4.12** Penetration Protection

