



DEPARTMENT OF PROCUREMENT SERVICES

CITY OF CHICAGO

Date: OCT 18 2011

To: Thomas H. Powers, P.E.
Commissioner
Department of Water Management

Attn: Felicia Rawlings
Supervisor of Contracts
Department of Water Management

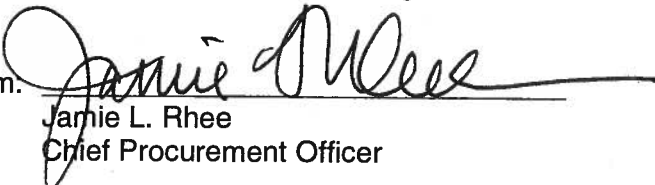
From: 
Jamie L. Rhee
Chief Procurement Officer

Re: Notice of Award of Emergency Contract
Flow Restrictor Valves

Specification:	98699	RX Number:	61172
PO/Contract:	25311	Amount:	\$249,967.62

Pursuant to Section 65 ILCS 5/8-10-5 of the Municipal Purchasing Act and 2-92-644 of the Municipal Code of Chicago, I am authorizing you to make an Emergency Contract for Flow Restrictor Valves with Quantum Engineering, Inc. Based upon information received from your office, I have determined that this procurement is necessary to meet a bona fide operating emergency.

You are hereby authorized to purchase Flow Restrictor Valves in the amount not to exceed \$249,967.62 as requested in your letter dated September 28, 2011. Any amount in excess of the \$249,967.62 will require additional authorization and will be limited so as not to exceed the \$250,000.00 limit established by the Chicago Municipal Code.

JLR/jpb

cc: Richard Butler
Gustavo Giraldo
James P. Bracewell Jr.
Julie Hernandez-Tomlin
Beverly Ingram
Michael Sturtevant
Felicia Rawlings
File Specification Number: 98699



DEPARTMENT OF PROCUREMENT SERVICES
CITY OF CHICAGO

Date: OCT 1 2011

Quantum Engineering, Inc.
Jason Raasch P.E., President
1001-D Nicholas Blvd.
Elk Grove Village, IL 60010

Subject: Notification of Award of Emergency Contract
Specification No.: 98699 PO/Contract No.: 25311
Amount: \$249,967.62
Project Description: Flow Restrictor Valves

Dear Mr. Raasch:

The City of Chicago has awarded your firm an emergency contract for Flow Restrictor Valves per your bid submitted on August 12, 2011 for the Department of Department of Water Management in an amount not to exceed \$249,967.62.

Attached, please find the City of Chicago Standard Purchase Order. Please refer to the Specification and Contract numbers listed above when inquiring about the contract. Please note that contracts are available for viewing and downloading on the City of Chicago's website: www.cityofchicago.org.

If you have any questions concerning this matter, please contact James P. Bracewell Jr., Director of Purchase Contract Administration, at 312-744-4923 or james.bracewell@cityofchicago.org.

Sincerely,

Jamie L. Rhee
Chief Procurement Officer

JLR/jpb

cc: Richard Butler
Gustavo Giraldo
James P. Bracewell Jr.
Julie Hernandez-Tomlin
Beverly Ingram
Michael Sturtevant
Felicia Rawlings
File Specification Number: 98699





SEP 29 2011
By *Judy Alvarez*

**DEPARTMENT OF WATER MANAGEMENT
CITY OF CHICAGO
MEMORANDUM**

TO: Jamie L. Rhee
Chief Procurement Officer
Department of Procurement Services
FROM: *Thomas H. Powers*
Thomas H. Powers, P.E. Commissioner
Department of Water Management -17-

A r/s
RB
YS r/s
:3 RC *B*

ATTN: James Bracewell
DATE: September 28, 2011

**SUBJECT: Recommendation of Award for Emergency Request (RX 61172)
Flow Restrictor Valves
Spec No. 98699
Total Bid \$249,967.62**

On 7/8/11, The Department of Procurement Services authorized The Department of Water Management to solicit bids for an emergency contract for Flow Restrictor Valves.

On 8/12/11, three (3) responses were received thru the Bid and Bond Room from the following vendors:

VENDOR	DESCRIPTION	UNIT PRICE
Contech Construction Products	Flow Restrictor Valves	\$222.50/ea
Hydro International	Flow Restrictor Valves	\$395.00/ea
Quantum Engineering, Inc.	Flow Restrictor Valves	\$39.69/ea

After further evaluation and testing of restrictors, DWM recommends that the emergency contract be awarded to Quantum Corporation in the amount of \$249,967.62, which would allow DWM to purchase approximately 6,298 Flow Restrictor Valves.

If you have any questions or need any additional information, feel free to contact Felicia Rawlings at 312-745-0581.

cc: Julie Hernandez-Tomlin
Beverly Ingram
Barrett Murphy
Michael Sturtevant
Felicia Rawlings



DEPARTMENT OF PROCUREMENT SERVICES
CITY OF CHICAGO

Date: JUL 08 2011

To: Thomas H. Powers, P.E.
Commissioner
Department of Water Management

Attn: Felicia Rawlings
Supervisor of Contracts
Department of Water Management

From: 
Jamie L. Rhee
Chief Procurement Officer

Re: Emergency Contract Request
Flow Restrictor Valves

Specification:	98699	Contract Term:	One Shot
RX Number:	61172	Estimate	\$250,000 <i>pb # 25311</i>

Based upon information received from your office, it has been determined that this procurement is necessary to meet a bona fide operating emergency.

You are hereby authorized to solicit new bids for Flow Restrictor Valves as requested in your letter dated June 28, 2011 and will be limited so as not to exceed the \$250,000.00 limit established by the Chicago Municipal Code.

Please make the necessary arrangements to have your solicitations received in the Bid and Bond Room at a mutually agreed upon time and date by fax or hard copy.

JLR/jpb

cc: Richard Butler
Gustavo Giraldo
James P. Bracewell Jr.
Alvin Jefferson
Carol Furco
Julie Hernandez-Tomlin
Beverly Ingram
Michael Sturtevant
Felicia Rawlings
File Specification Number: 98699

**CITY OF CHICAGO
STANDARD PURCHASE ORDER**

Copy (Department)
Reprint

Furnish the supplies and/or services described below in conformance with conditions set forth herein and in your offer.

DATE OF AWARD	DEPARTMENT NUMBER	PURCHASE ORDER	SPECIFICATION NUMBER	VENDOR NUMBER	SITE NAME	DELIVERY DATE	PAGE NUMBER
10/19/2011	88	25311	98699	55275024	A		1

DELIVER TO:

D26
1424 W. PERSHING
CHICAGO, ILLINOIS 60609, IL

ORDERED FROM:

QUANTUM ENGINEERING CORPORATION
740 BRIGHTON CIRCLE
PORT BARRINGTON, IL 60010

DELIVERY CHARGES to be PREPAID
TITLE TO PASS ON DELIVERY

BUYER: 29014 JAMES BRACEWELL

PO DESCRIPTION: EMERGENCY CONTRACT FOR FLOW RESTRICTOR VALVES

PO Line	Ship Line	COMMODITY INFORMATION						QUANTITY	UOM	UNIT COST	TOTAL COST		
1	1	81573 VALVES - SEWER LINE INTAKE FLOW RESTRICTOR, TYPE 1 RESTRICTOR VALVES FOR 8" DIAMETER CATCH BASIN OUTLET						6,298	USD	39.69	249,967.62		
		Dist	BFY	FUND	COST CTR	APPR	ACCNT	ACTV	PROJECT	RPT CAT	GENRL	FUTR	TOTAL COST
		1	011	0F06	0882005	6032	220540	0000	60016151	000000	000000	0000	249,967.62
PO LINE and SHIPMENT LINE TOTAL:											249,967.62		

PURCHASE ORDER TOTAL: 249,967.62

Payment on this order will be made upon receipt of an original vendor invoice form referencing this order and associated Receipt(s). Submit the original invoice to the Office of the City Comptroller, Invoice Intake Division, 33 N. LaSalle, Room 700, Chicago, IL 60602. Mark all packages and papers with the purchase number. Any deliveries containing overshipments will be reflected unless otherwise authorized in this purchase. This purchase is subject to the City of Chicago General Conditions for Supplies, Work, or Professional Consulting Services; Special Conditions, Disclosure Ownership, Acceptance Page, as applicable, which are attached hereto or incorporated herein by reference.

City of Chicago
Department of Water Management
Rahm Emanuel, Mayor
Thomas H. Powers, P.E., Commissioner

REC 11/15/11
11 00 12

011



DePaul Center - 333 South State Street, Suite 410 Chicago, Illinois 60604-3971 Phone (312) 747-8037 Fax (312) 747-0838

Fax Transmittal

Date: 8/5/2011

Pages including cover sheet 3

To: Jason Raasch P.E. - Owns Patent (Attached) - Owns Quantum Engineering
Dept: Quantum Corp. 1001-D Nicholas Blvd. Elk Grove Village IL 60010
Fax: 847-357-1990 Phone: 847-951-7686

From: Margarita Alvarez

Fax: 312-742-9087

Phone: 312-747-1683

Subject: REQUEST FOR PRICE QUOTE - Flow Restrictors #39⁰² each

Remarks:

The Department of Water Management is requesting quotes for an emergency contract for Restrictors. Please forward your responses via fax to DPS Bid & Bond Room no later than Friday, August 12, 2011, at 11:00 am. They should be faxed to 312-744-5611. Thanks for your responses.

IMPORTANT: THIS MESSAGE IS INTENDED ONLY FOR THE USE OF THE INDIVIDUAL OR ENTITY TO WHICH IT IS ADDRESSED. THIS FACSIMILE MAY CONTAIN INFORMATION THAT IS PRIVILEGED, CONFIDENTIAL AND EXEMPT FROM DISCLOSURE UNDER APPLICABLE LAW. YOU ARE HEREBY NOTIFIED THAT ANY DISSEMINATION, DISTRIBUTION OR COPYING OF THIS COMMUNICATION IS STRICTLY PROHIBITED. IF YOU ARE RECEIVING THIS COMMUNICATION IN ERROR, PLEASE NOTIFY US IMMEDIATELY AND RETURN THE ORIGINAL MESSAGE TO THE ADDRESS VIA UNITED STATES POSTAL SERVICE. THANK YOU.



DEPARTMENT OF WATER MANAGEMENT
CITY OF CHICAGO

August 5, 2011

The Department of Water Management would like to request emergency quotes for Restrictors. The restrictors must meet a required design release rate of 0.15 cfs (+ 0.015 CFS) with 4 feet of head; they must be able to securely fastened to the inside of a catch basin with 8" diameter half-trap outlet; be easily installed and removed and require a minimum amount of maintenance by inhibiting clogging.

The Department of Water Management will also need supporting documentation that the supplier has a legal right/license to supply restrictors.

The Contractor must be the manufacturer or an authorized dealer or distributor of the proposed restrictor. The Contractor must be able to provide genuine parts, assemblies and/or accessories as supplied by the original equipment manufacturer (OEM). Further, the Contractor must be able to provide original product warranty and manufacturer's related services such as product information, product recall notices, etc. Documentation which validates the Contractor's current status of authorized dealer or distributor must be submitted with the bid. Contractor must also demonstrate that it has authorization to transfer product warranties to the City of Chicago.

Contractor must defend, indemnify, keep and hold harmless the City, its officers, representatives, elected and appointed officials, agents and employees from and against any and all Losses (as defined below), including those related to: injury, death or damage of or to any person or property; any infringement or violation of any property right (including any patent, trademark or copyright); failure to pay or perform or cause to be paid or performed Contractors covenants and obligations as and when required under this Contract or otherwise to pay or perform its obligations to any subcontractor; the City's exercise of its rights and remedies under this Contract; and injuries to or death of any employee of Contractor or any subcontractor under any workers compensation statute.

Contractor must defend, indemnify, keep and hold harmless the City, its officers, representatives, elected and appointed officials, agents and employees from and against any and all Losses (as defined below), including those related to: injury, death or damage of or to any person or property; any infringement or violation of any property right (including any patent, trademark or copyright); failure to pay or perform or cause to be paid or performed Contractors covenants and obligations as and when required under this Contract or otherwise to pay or perform its obligations to any subcontractor; the City's exercise of its rights and remedies under this Contract; and injuries to or death of any employee of Contractor or any subcontractor under any workers compensation statute.

"Losses" means, individually and collectively, liabilities of every kind, including monetary damages and reasonable costs, payments and expenses (such as, but not limited to, court costs and reasonable attorneys' fees and disbursements), claims, demands, actions, suits, proceedings, judgments or settlements, any or all of which in any way arise out of or relate to the acts or omissions of Contractor, its employees, agents and subcontractors.

At the City Corporation Counsel's option, Contractor must defend all suits brought upon all such Losses and must pay all costs and expenses incidental to them, but the City has the right, at its option, to participate, at its own cost, in the defense of any suit, without relieving Contractor of any of its obligations under this Contract. Any settlement must be made only with the prior written consent of the City Corporation Counsel, if the settlement requires any action on the part of the City.

Name of Company:

Quantum Engineering Inc.
(Print or Type)

Signature-Designee/Title:

Jason Rasch - President
(Print or Type)

Business Address:

1001-B Nicholas Blvd. Elk Grove Village IL 60010
(Print or Type)

Date:

(Print or Type)

File Number 6077-521-4

State of Illinois Office of The Secretary of State

Whereas,

ARTICLES OF INCORPORATION OF
QUANTUM ENGINEERING CORPORATION
INCORPORATED UNDER THE LAWS OF THE STATE OF ILLINOIS HAVE BEEN
FILED IN THE OFFICE OF THE SECRETARY OF STATE AS PROVIDED BY THE
BUSINESS CORPORATION ACT OF ILLINOIS, IN FORCE JULY 1, A.D. 1984.

Now Therefore, I, Jesse White, Secretary of State of the State of Illinois, by virtue of the powers vested in me by law, do hereby issue this certificate and attach hereto a copy of the Application of the aforesaid corporation.

In Testimony Whereof, I hereto set my hand and cause to be affixed the Great Seal of the State of Illinois, at the City of Springfield, this 23RD day of NOVEMBER A.D. 1999 and of the Independence of the United States the two hundred and 24TH



Jesse White

Secretary of State

*United States Patent
Granted To*

Jason Raasch P.E.

July 4, 2000 NUMBER: 6,082,925

**STORM SEWER
OVERFLOW CONTROL DEVICE**

*The
United
States
of
America*

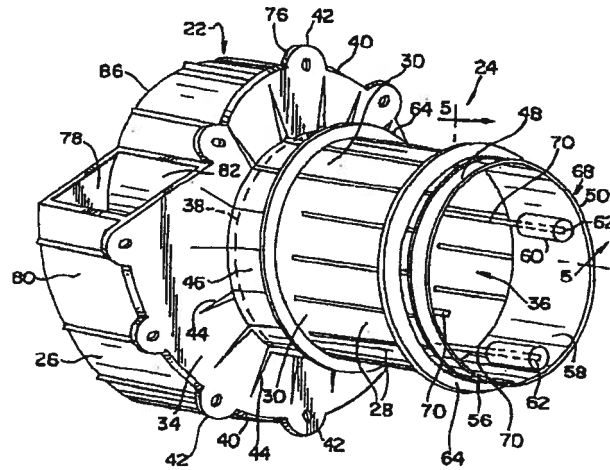

The Commissioner of Patents and Trademarks has received an application for a patent for a new and useful invention. The requirements of law have been complied with, and it has been determined that a patent on the invention shall be granted under the law.

Therefore, this

United States Patent

Grants to the person or persons having title to this patent the right to exclude others from making, using or selling the invention throughout the United States of America for the term of this patent, subject to the payment of maintenance fees as provided by law.

J. Todd Johnson
Director of the U.S. Patent and Trademark Office



Quantum Engineering, Inc.

Emergency Contract Bid for Flow Restrictors

Bid Price \$39.69 each For Full \$250,000.00 Contract

Fixed Flow Units Bid Price \$39.69 each (6,298 units for \$250,000)

Aggressive "Super-Tough" Ribs - Resist Impact – Protect unit from impact/breakage (typical impact from large cleaning pipe during spring clean) and projectiles such as rocks and fasteners from vehicles overhead.

Pre-Filtration Grate – Eliminates Clogging from floating debris such as tennis balls, golf balls, sticks, leaves etc. keeping them away from inlet.

Dual-Plane Intakes – Reduce clogging from rags, bags & magazines

Lifting Vane – Lifts sediment gravel and Sand within swirl chamber keeping it in suspension and flowing through orifice rather than building up on swirl chamber bottom. Sediment buildup changes flows drastically by changing swirl chamber geometry as well as creating drag ultimately putting the "Brakes" on turbo-dynamics.

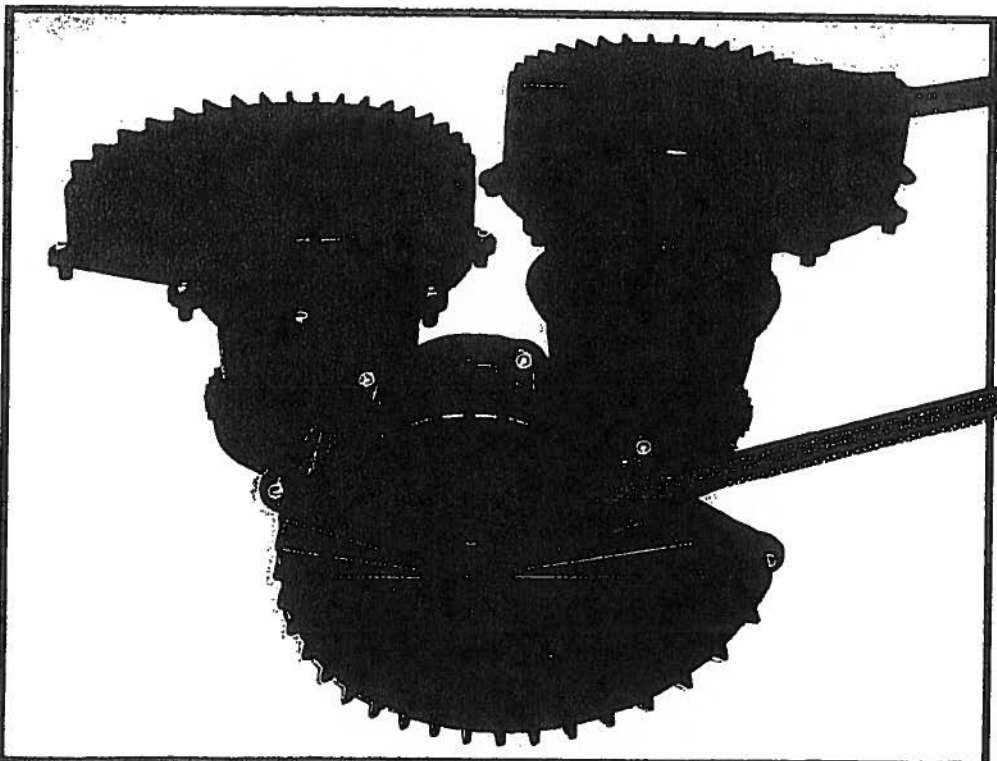

Aggressive "Super-Tough" Ribbed Design

Aggressive rib design atop swirl chamber, protects head unit from failure. Sharp impacts from vehicle projectiles such as rocks and fasteners through grate challenge flow integrity. Largest threat is the truck mounted Vac-Tube during spring-clean.

Quantum Engineering, Inc.

Emergency Contract Bid for Flow Restrictors
Bid Price \$39.69 Each For Full \$250,000.00 Contract

Inlet Clog Resistance

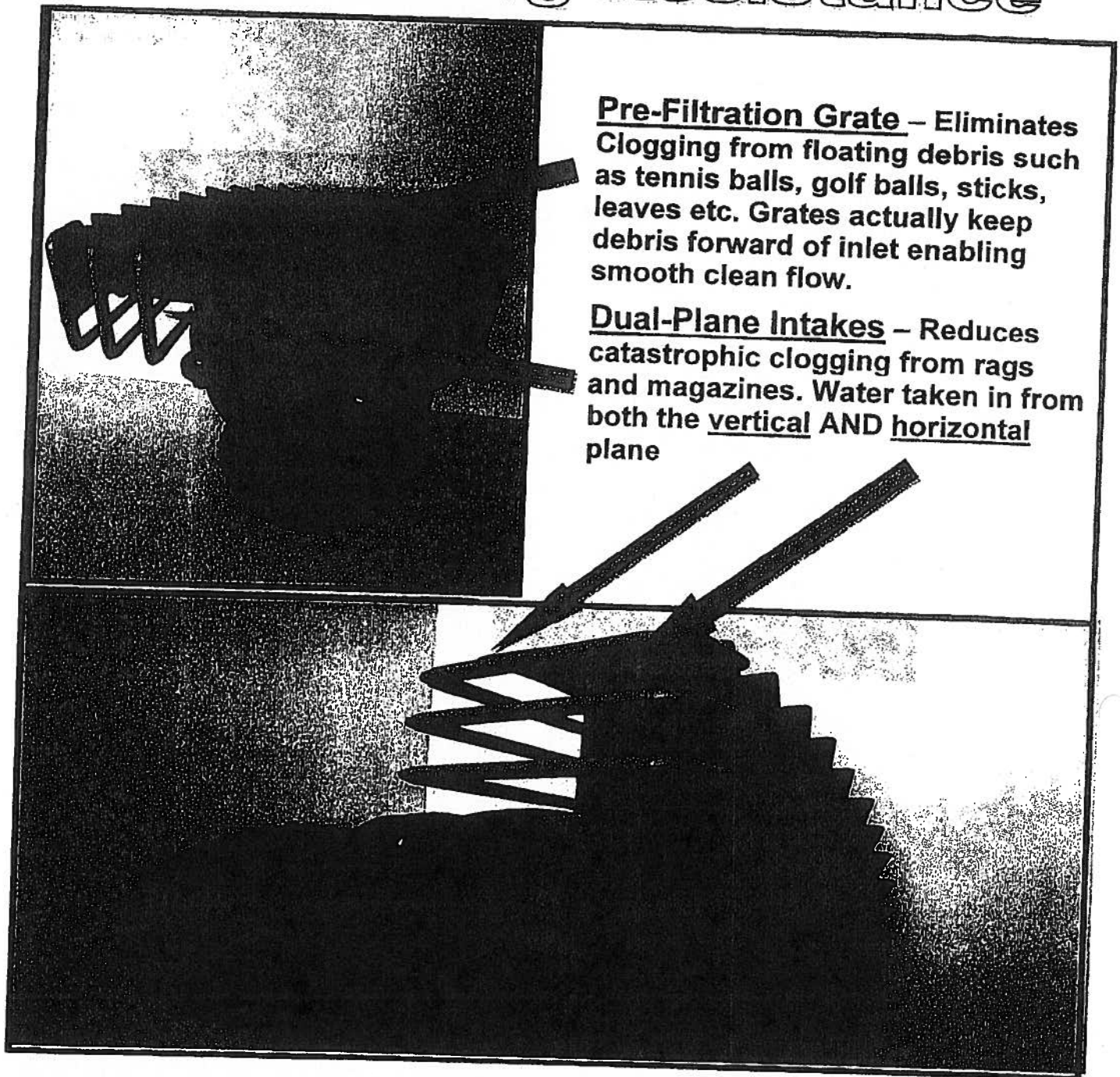

Pre-Filtration Grate – Eliminates Clogging from floating debris such as tennis balls, golf balls, sticks, leaves etc. Grates actually keep debris forward of inlet enabling smooth clean flow.

Dual-Plane Intakes – Reduces catastrophic clogging from rags and magazines. Water taken in from both the vertical AND horizontal plane

Quantum is the manufacturer of Dyna-Sewers– Buy Direct -Jason Raasch Owns Rights
 Quantum Engineering, Inc. 847-951-7686 F 847-381-7406 E:AAUN2011@Hotmail.com

Quantum Engineering, Inc.

Emergency Contract Bid for Flow Restrictors Dyna-Sewer Flow Restrictors

Sediment Lifting Vane – Lifts sediment gravel and Sand within swirl chamber keeping it in suspension and flowing through orifice rather than building up on swirl chamber bottom. Sediment buildup changes flows drastically by changing swirl chamber geometry as well as creating drag ultimately putting the “Brakes” on turbo-dynamics.

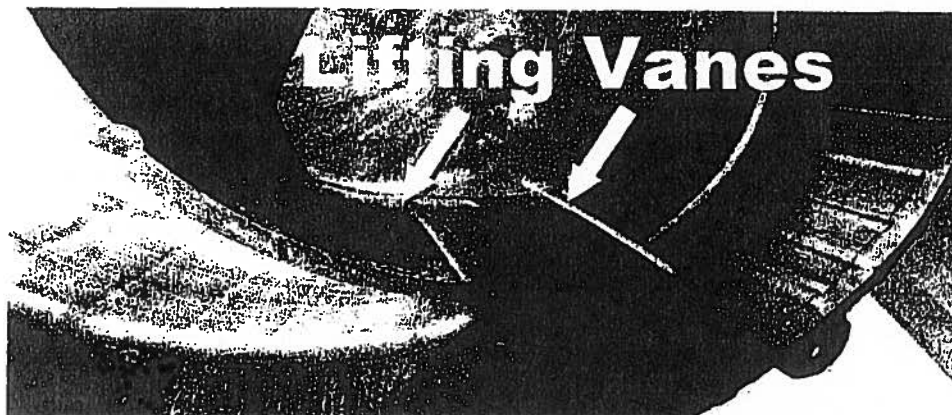

Adjustable Flow Option - Add \$12

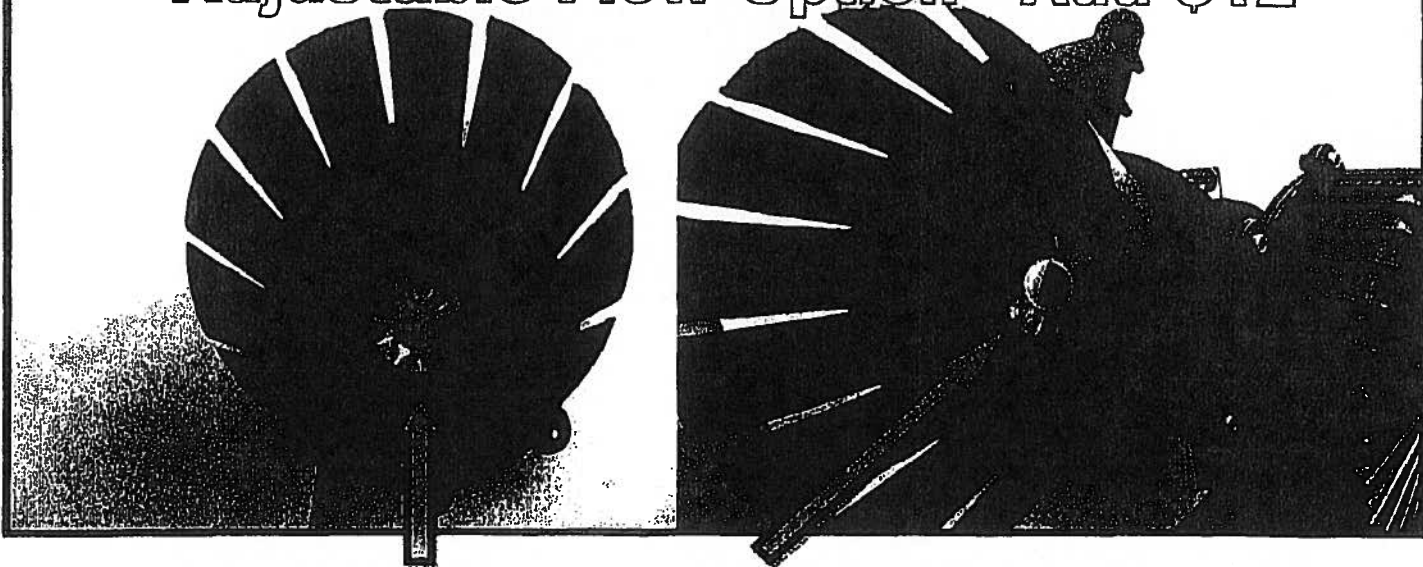

Adjustable Flow Option – Add \$10 - facilitates fine tune flow rates from site-to-site. Units are molded to the City of Chicago's specifications with additional flow control adjustable in the field real time. This Feature improves Program success by Allowing Fine-Tune Adjustments to address differences in elevation, absorption, etc. with an external adjustability by street crews after rain events.

City of Chicago
Department of Water Management
Rahm Emanuel, Mayor
Thomas H. Powers, P.E., Commissioner



DePaul Center - 333 South State Street, Suite 410 Chicago, Illinois 60604-3971 Phone (312) 747-8037 Fax (312) 747-0838

Fax Transmittal

Date: 8/5/2011

Pages including cover sheet 3

To: Jason Raasch P.E.

Dept: Quantum Corp.

Fax: 847-357-1990 **Phone:**847-951-7686

From: Margarita Alvarez

Fax: 312-742-9087

Phone: 312-747-1683

Subject: REQUEST FOR PRICE QUOTE

Remarks:

The Department of Water Management is requesting quotes for an emergency contract for Restrictors. Please forward your responses via fax to DPS Bid & Bond Room no later than Friday, August 12, 2011, at 11:00 am. They should be faxed to 312-744-5611. Thanks for your responses.

IMPORTANT: THIS MESSAGE IS INTENDED ONLY FOR THE USE OF THE INDIVIDUAL OR ENTITY TO WHICH IT IS ADDRESSED. THIS FACSIMILE MAY CONTAIN INFORMATION THAT IS PRIVILEGED, CONFIDENTIAL AND EXEMPT FROM DISCLOSURE UNDER APPLICABLE LAW. YOU ARE HEREBY NOTIFIED THAT ANY DISSEMINATION, DISTRIBUTION OR COPYING OF THIS COMMUNICATION IS STRICTLY PROHIBITED. IF YOU ARE RECEIVING THIS COMMUNICATION IN ERROR, PLEASE NOTIFY US IMMEDIATELY AND RETURN THE ORIGINAL MESSAGE TO THE ADDRESS VIA UNITED STATES POSTAL SERVICE. THANK YOU.

Result Summary

Job Number	59846	Submitted	8/5/2011 2:24:33 PM
Subject		Recipients	1
Total Pages	3	Successful	Yes
Billing Info			

Recipient Results

Name	Number/ Address	Result	Elapsed Time
	918473571990	Success	01:48

City of Chicago
Department of Water Management
 Rahm Emanuel, Mayor
 Thomas H. Powers, P.E., Commissioner



City of Chicago - 333 South State Street, Suite 410 Chicago, Illinois (60604-5971) Phone: (312) 747-6017 Fax: (312) 747-6018

Fax Transmittal

Date: 8/5/2011

Pages including cover sheet: 3

To: Jason Knauth, P.E. _____

Dept: Christian Corp. _____

Fax: 847-357-1799 Phone: 847-231-7030

From: Matthew Alvarez _____

Fax: 312-747-0067 _____

Phone: 312-747-1683 _____

Subject: REQUEST FOR PRICE QUOTE _____

Remarks:

The Department of Water Management is requesting quotes for an emergency contract for Resinators. Please forward your responses via fax to DE'S Rod & Heidi Rosen no later than Friday, August 12, 2011, at 11:00 am. They should be faxed to 312-744-5611. Thanks for your response.

IMPORTANT: THIS MESSAGE IS INTENDED ONLY FOR THE USE OF THE INDIVIDUAL OR ENTITY TO WHICH IT IS ADDRESSED. THIS FACSIMILE MAY CONTAIN INFORMATION THAT IS PRIVILEGED, CONFIDENTIAL AND EXEMPT FROM DISCLOSURE UNDER APPLICABLE LAW. YOU ARE HEREBY NOTIFIED THAT ANY DISSEMINATION, DISTRIBUTION OR COPYING OF THIS COMMUNICATION IS STRICTLY PROHIBITED. IF YOU ARE RECEIVING THIS COMMUNICATION IN ERROR, PLEASE NOTIFY US IMMEDIATELY AND RETURN THE ORIGINAL MESSAGE TO THE ADDRESS VIA UNITED STATES POSTAL SERVICE. THANK YOU.