

(C1)

(P)

97289373

DEPT-01 RECORDING \$519.00
 T0012 TRAN 4843 04/25/97 03:27:00
 \$1192 CG *-97-289373
 COOK COUNTY RECORDER

4649349 AT RF

BLOCK 36, NORTH LOOP PROJECT
 REDEVELOPMENT AGREEMENT
 ORIENTAL THEATER

5/9.00
cfe

This instrument prepared by,
 and after recording, please return to:

Mark Lenz
 Assistant Corporation Counsel
 City of Chicago
 Department of Law
 30 North LaSalle Street, Room 1610
 Chicago, Illinois 60602

97289373

REDEVELOPMENT AGREEMENT
ORIENTAL THEATER
TABLE OF CONTENTS

RECITALS 1

DEFINITIONS 7

SECTION I
INCORPORATION OF RECITALS AND DEFINITIONS 15

SECTION II
COVENANTS, REPRESENTATIONS AND WARRANTIES 15

 2.1 Covenants, Representations and Warranties of Developer. 15

 2.2 Representations and Warranties of the City. 19

 2.3 Survival of Representations and Warranties. 19

SECTION III
CONVEYANCE OF THE OLIVER PROPERTY 19

 3.1 Acquisition of Oliver Property by the City. 19

 3.2 Form of Deed. 20

 3.3 Conveyance of the Oliver Property. 21

 3.4 Closing Documents. 23

 3.5 Title Insurance and Survey. 23

 3.6 Real Estate Taxes. 24

 3.7 Recordation of Deed. 24

SECTION IV
THE CONSTRUCTION OF THE PROJECT 24

 4.1 Assembling the Site. 24

 4.2 The Project. 28

 4.3 The Project's Development Parameters. 28

 4.4 Right of Entry. 30

 4.5 Submission of Construction Documents; Environmental Review. 31

 4.6 Limited Applicability of DPD's Approval. 35

 4.7 Construction Schedule; Hiring of Contractors; Performance Bond; Purchase of Materials. 35

 4.8 Financing the Project. 43

 4.9 Relocation of Utilities. 62

 4.10 Commencement and Completion of the Project. 63

 4.11 Barricades. 63

 4.12 Signs and Public Relations. 64

 4.13 Certificate of Completion. 64

 4.14 Insurance. 65

 4.15 Prohibition Against Unpermitted Encumbrances. 72

 4.16 Mortgagees Not Obligated to Construct. 72

97289373

SECTION V
PERFORMANCE 74

- 5.1 Time of the Essence. 74
- 5.2 Permitted Delays. 74
- 5.3 Breach. 75
- 5.4 Waiver and Estoppel. 86
- 5.5 Indemnity. 86
- 5.6 Access to the Site. 86
- 5.7 City's Right to Inspect Records. 87

SECTION VI
DEVELOPER'S EMPLOYMENT OPPORTUNITY OBLIGATION 87

- 6.1 Employment Opportunity. 87
- 6.2 City Resident Employment Requirement. 89
- 6.3 Developer's MBE/WBE Commitment. 92
- 6.4 Pre-Construction Meeting;
Monitoring Requirements. 95

SECTION VII
PUBLIC POLICY COVENANTS AND
POST-CERTIFICATE REQUIREMENTS 96

- 7.1 Developer's Public Policy Covenants. 96
- 7.2 Use and Performance Requirements. 97
- 7.3 Employment Creation and Retention;
Covenant to Remain in the City. 98
- 7.4 Public Benefits Program. 98
- 7.5 Agreement to Provide Assistance to the
Chicago School Reform Board of Trustees. 99
- 7.6 Status Reports. 99
- 7.7 Real Estate Taxes and Other Governmental Charges. 99
- 7.8 Covenants Running with the Land. 103

SECTION VIII
MISCELLANEOUS PROVISIONS 104

- 8.1 Entire Agreement. 104
- 8.2 Assignability and Transfer. 105
- 8.3 Conflict of Interest - City's Representatives
Not Individually Liable. 105
- 8.5 Survival. 106
- 8.6 Mutual Assistance. 106
- 8.7 Cumulative Remedies. 106
- 8.8 No Merger with Deed. 106
- 8.9 Disclaimer. 106
- 8.10 Notices. 107
- 8.11 Headings. 108
- 8.12 Governing Law. 108
- 8.13 Recordation of the Agreement. 108
- 8.14 Release.
- 8.15 No Third Party Beneficiary. 108
- 8.16 Approval. 109

97289373

8.17 Successors and Assigns. 109
8.18 Severability. 109
8.19 Counterparts. 109
LIST OF EXHIBITS 115

97289373

**BLOCK 36, NORTH LOOP PROJECT
REDEVELOPMENT AGREEMENT
ORIENTAL THEATER**

This Redevelopment Agreement ("Agreement"), dated as of April 29, 1996, is made by and between the City of Chicago, an Illinois municipal corporation, having its offices at City Hall, 121 North LaSalle Street, Chicago, Illinois 60602 ("City") and Livent Realty (Chicago) Inc., a Delaware corporation, having its principal office at 165 Avenue Road, Suite 600, Toronto, Ontario, Canada M5R 3S4 ("Developer").

RECITALS

A. The City, as a home rule unit under the 1970 Constitution of the State of Illinois, has the authority to promote the health, safety and welfare of its inhabitants, to prevent the spread of blight and to encourage private development in order to enhance the local tax base and create employment, and to enter into contractual agreements with third parties for the purpose of achieving the aforesaid purposes.

B. In furtherance of its objectives to encourage the redevelopment and revitalization of blighted commercial areas, the City established the Commercial District Development Commission, which has been succeeded in interest by the Community Development Commission ("Commission").

C. On March 20, 1979, the Commission designated an area within the corporate boundaries of the City as a blighted commercial area to be known as "Blighted Commercial Area North Loop" ("Redevelopment Area"), and on March 20, 1979, approved a redevelopment plan ("Redevelopment Plan") for the Redevelopment Area. The blighted commercial area designation was approved by the City Council of the City of Chicago ("City Council"), pursuant to an ordinance duly adopted on March 28, 1979. The Redevelopment Plan was approved by the City Council pursuant to an ordinance duly adopted on March 28, 1979 and, as revised, was approved by an ordinance adopted on October 27, 1982. The North Loop Guidelines for Conservation and Redevelopment ("Guidelines") pertaining to the Redevelopment Area, were approved by the Commission on March 31, 1981, approved and revised by the Chicago Plan Commission on May 14, 1981, and, as so revised, were approved by the City Council on October 22, 1981; as further revised by the Commission on October 12, 1982, and, as so further revised, approved by the Chicago Plan Commission on October 14, 1982, and, with additional revisions, were further approved by the City Council on October 27, 1982; and as further revised and approved by the Chicago Plan Commission on September 2, 1987, were further approved by the City Council on September 23, 1987; and as further revised by the Commission on January 24, 1989, were finally approved by the City Council on March 29, 1989.

D. The City is authorized under the provisions of the Tax Increment Allocation Redevelopment Act, 656 ILCS 5/11-74.4-1 et.

seq. (1994 State Bar Edition), as amended from time to time (the "TIF Act"), to finance projects that eradicate blighted conditions through the use of tax increment allocation financing for redevelopment projects.

E. To induce redevelopment pursuant to the TIF Act, the City Council adopted the following ordinances on June 20, 1984: (1) An ordinance regarding "Authority Granted for Approval of Tax Increment Redevelopment Plan and Redevelopment Project for North Loop Redevelopment Project" ("TIF Plan"); (2) An ordinance regarding "Authority Granted for Designation of North Loop Tax Increment Redevelopment Project Area"; and (3) An ordinance regarding "Authority Granted for Adoption of Tax Increment Financing for North Loop Tax Increment Redevelopment Project Area" (the "TIF Adoption Ordinance") (sometimes collectively referred to herein as the "TIF Ordinances"). The designated redevelopment project area is included within the Redevelopment Area.

F. As more specifically defined hereinafter, the "Redevelopment Documents" are comprised of the Redevelopment Plan, the Guidelines and the TIF Plan. The Redevelopment Documents set forth: (i) the City's general objectives for the Redevelopment Area; and (ii) certain specific planning and design criteria for the Redevelopment Area.

G. As contemplated in the Agreement, Developer seeks and intends to acquire, pursuant to the Option Agreement (as hereinafter defined), certain real estate (and related equipment, fixtures and chattels) located within Block 36 (hereinafter

defined) of the Redevelopment Area, which is part of and is to be legally severed in ownership from the improved real estate known as the 32 West Randolph Street Building situated at 32 West Randolph Street, Chicago, Illinois and shall consist of the land and area thereof comprising the now vacant historic Oriental Theater, retail property containing approximately 7,000 square feet of retail space on three levels (basement, first floor and second floor) on West Randolph Street adjacent to the Oriental's main entrance and other appurtenances, all as will be determined by survey and the so-called Reciprocal Rights Agreement pursuant to the Option Agreement. For purposes of the Agreement such real estate shall be referred to as the "Oriental Property" and is legally described on Exhibit A attached hereto (as the same may be revised from time to time).

H. In accordance with the terms of the Agreement, the City shall take the steps provided for herein to acquire that certain parcel of real estate located within Block 36 of the Redevelopment Area, which is presently improved with a four story office building commonly referred to as the "Oliver Building" located at 159 North Dearborn Street, Chicago, Illinois, and to terminate the tenant occupancies thereof so that Developer may gain vacant possession thereof. For purposes of the Agreement, such real estate shall be referred to as the "Oliver Property" and is also legally described on Exhibit A attached hereto and the building thereon shall be referred to as the "Oliver Building."

I. The facade of the Oliver Building has been designated as a Chicago landmark pursuant to the terms of that certain ordinance ("Landmarks Ordinance") adopted by the City Council on May 9, 1984 (C.J.P. pgs. 6511-12), as corrected by that certain Ordinance adopted July 9, 1984 (C.J.P. pg. 8172). The Oliver Building is also subject to the terms and conditions described in that certain preservation easement ("Preservation Easement") between the City and Chicago Title and Trust Co. Trust #53891, which easement is dated as of December 14, 1983 and recorded with the Office of the Recorder of Deeds of Cook County, Illinois ("Recorder's Office") as document #26910729. In particular, the Preservation Easement provides for the historic preservation of the exterior facade of the Oliver Building facing North Dearborn Street.

J. Pursuant and subject to the terms of the Agreement, the City, subsequent to acquisition, will convey fee simple title to the Oliver Property to Developer. Acquisition of the nearby Oliver Building is an essential component because its interior will be reconstructed to accommodate the expansion of theater stage, which is vital to being able to accommodate the demands of large scale contemporary musical theater productions. Developer shall redevelop the Oliver Property and the Oriental Property as the "new" Oriental Theater, with retail facilities compatible with the operation of the Oriental Theater adjacent to its entrance on West Randolph Street. The improvements shall include a theater with approximately 2,180 seats (reduced from the former estimated seating capacity of 3,200) and a rehearsal hall, together with

ancillary facilities, including, without limitation, a box office, lobbies, reception suite, concession and merchandising areas, administrative offices, dressing rooms, wardrobe, maintenance and laundry facilities, and other support facilities compatible with the operation of a first class live theater, and approximately 7,000 square feet of retail space and shall provide for the historic renovation and/or rehabilitation, as needed, of the facade of the Oliver Building (the "Project" as more fully described below).

K. The City (as further described in the Agreement) has agreed to pay for or reimburse Developer for certain activities in conjunction with the assemblage of the Site (as hereinafter defined) and the construction of the Project utilizing Incremental Taxes (as hereinafter defined) collected as a result of the TIF Adoption Ordinance.

L. Developer and the City acknowledge that the implementation of the policies and provisions described in the Redevelopment Documents and the Agreement will be of mutual benefit to Developer and the City.

NOW, THEREFORE, in consideration of the mutual covenants and agreements contained herein, the parties hereto hereby agree as follows:

DEFINITIONS

For all purposes of the Agreement, each of the following terms shall have the respective meaning assigned to it as follows:

Affidavits: Those certain affidavits and certifications executed and delivered by Developer as required by the City and consisting of an Economic Disclosure Statement, Anti-Scofflaw Affidavit, Certification Regarding Lobbying and any other customary affidavit or certification required by the City in connection with the Agreement and its undertaking to provide the City's Financial Contribution (as hereinafter defined).

Affiliate: Any person or entity directly or indirectly controlling, controlled by or under the common control with Developer.

Agreement to Provide Assistance to the Chicago School Reform Board of Trustees: That certain agreement to be entered into between the City and Developer in connection with the Agreement substantially in the form attached hereto as Exhibit M.

Architect: One or both of the co-architects designing the Project, namely Daniel P. Coffey & Associates and Kofman Engineering Limited.

Block 36: That certain block located in the City's Loop bounded on the east by North State Street, on the west by North Dearborn Street, on the south by West Randolph Street and on the north by West Lake Street. The block is commonly referred to as "Block 36" of the City's North Loop Redevelopment Area.

Certificate: The certificate of completion to be issued by the City once the construction of the Project has been completed, in accordance with subsection 4.13 below.

City: The City of Chicago, an Illinois municipal corporation.

City Fee: The fee described in subsection 8.4 of the Agreement.

City's Financial Contribution: The funds to be spent by the City from Incremental Taxes described and defined as such in subsection 4.8(b) below.

Commission: The Community Development Commission of the City of Chicago.

Commissioner: The Commissioner of Planning and Development of the City of Chicago.

Completion: The substantial completion of the Project. The Project shall be considered substantially complete when improvements and all common or public areas of the Project are substantially finished and ready for use and occupancy for the purpose intended.

Completion Guaranty: That certain Completion Guaranty to be provided by Livent to the City substantially in the form attached hereto as Exhibit Q in order to induce the City to enter into the Agreement.

Component: Those certain drawings, sketches, charts, details and specifications that correspond to each of the demolition, construction or renovation activities constituting the Project, and

which collectively shall comprise the Working Drawings and Specifications for the Project.

Component Contract: Any construction contract (approved by the DPD) between the Construction Manager and a Contractor or itself to undertake the various Component Work of the Project.

Component Work: The work associated with a particular Component and undertaken pursuant to an executed Component Contract and defined as such in subsection 4.5(b).

Construction Manager: The entity hired by Developer and approved by the DPD to hire a Contractor or Contractors or to act as Contractor itself and to coordinate the construction of a Component or various Components.

Contractor: A general or prime contractor meeting the prior approval of the DPD hired by the Construction Manager (which may be the Construction Manager itself) to undertake the completion of the various Component Work constituting the Project, as further described in subsection 4.7(c) below.

Covenant of Performance: The covenant of performance to be provided by Developer to the City in connection with the Mortgage and defined as such in subsection 4.8(b) below.

Demolition Contractor: That certain contractor meeting the prior approval of the City hired by Developer or the Construction Manager as the demolition contractor to undertake the Demolition Component Work as further described in Section 4.7(b) below.

Developer: Livent Realty (Chicago) Inc., a Delaware corporation.

Developer's Financial Contribution: The funds for the Project to be provided by Developer described and defined as such in subsection 4.8(a) below.

DPD: City of Chicago Department of Planning and Development.

Equity: The cash funds or direct-pay letter of credit comprising part of Developer's Financial Contribution to be delivered to the City in accordance with the provisions of subsection 4.8(a) below.

Environmental Laws: Any and all federal, state or local statutes, laws, regulations, ordinances, codes, rules, orders, licenses, judgments, decrees or requirements relating to public health and safety and the environment now or hereafter in force, as amended and hereafter amended, including but not limited to (i) the Comprehensive Environmental Response, Compensation and Liability Act (42 U.S.C. Section 9601 et seq.); (ii) any so-called "Superfund" or "Superlien" law; (iii) the Hazardous Materials Transportation Act (49 U.S.C. Section 1802 et seq.); (iv) the Resource Conservation and Recovery Act (42 U.S.C. Section 6902 et seq.); (v) the Clean Air Act (42 U.S.C. Section 7401 et seq.); (vi) the Clean Water Act (33 U.S.C. Section 1251 et seq.); (vii) the Toxic Substances Control Act (15 U.S.C. Section 2601 et seq.); (viii) the Federal Insecticide, Fungicide and Rodenticide Act (7 U.S.C. Section 136 et seq.); (ix) the Illinois Environmental Protection Act (415 ILCS 5/1 et seq.); and (x) the Municipal Code of Chicago.

Escrow: That certain construction escrow to be created by the parties pursuant to the provisions described in subsection 4.8(c) below.

Hazardous Materials: Any toxic substance, hazardous substance, hazardous material, hazardous chemical or hazardous, toxic or dangerous waste defined or qualifying as such in (or for the purposes of) any applicable environmental law, or any pollutant or contaminant, and shall include, but not be limited to, petroleum (including crude oil), any radioactive material or by-product material, polychlorinated biphenyls and asbestos in any form or condition.

Incremental Taxes: Ad valorem taxes which, pursuant to the TIF Adoption Ordinance and Section 5/11-74.4-8(b) of the TIF Act, are allocated to and when collected are paid to the Treasurer of the City of Chicago for deposit by the Treasurer into a special tax allocation fund established to pay Redevelopment Project Costs and obligations incurred in the payment thereof.

Inspector: The independent inspector selected by the City and Developer pursuant to subsection 4.8(c)(6) below.

Landmarks Commission: The Commission on Chicago Landmarks of the City.

Livent: Livent Inc., an Ontario, Canada, corporation.

Mortgage: The mortgage in favor of the City described and defined as such in subsection 4.8(b) below.

Oliver Building: That certain building in Block 36 and defined as such in Recital H.

Oliver Property: That certain real estate in Block 36 and defined as such in Recital H presently owned or to be acquired by the City and conveyed to Developer as contemplated in the Agreement.

Option Agreement: That certain Option Agreement, Oriental Theater, Chicago, made as of June 6, 1995 by and among 32 West Randolph Street Limited Partnership, as Vendor, Developer, as Purchaser, and American National Bank and Trust Company of Illinois Trust No. 10-5522-06, as Land Trustee, relating to the sale of the Oriental Property, as the same may be amended from time to time.

Oriental Property: That certain real estate in Block 36 and defined as such in Recital G.

Oriental Theater: The theater consisting of approximately 2,180 seats and a rehearsal hall, to be constructed and redeveloped by Developer at the Site, together with ancillary facilities including, without limitation, the following: the box office, lobbies, reception suite, concession and merchandising areas and various backstage facilities including dressing rooms, wardrobe, maintenance and laundry facilities, administrative offices and other support facilities.

Project: The historic renovation and/or rehabilitation, as needed, of the facade of the Oliver Building and the construction and development of the Oriental Theater and related improvements by Developer at the Site, including the development of approximately 7,000 square feet of adjacent retail space compatible with the operation of a first class live theater (all as further described

in Recital J and subsections 4.2 and 4.3 of the Agreement), in accordance with Working Drawings and Specifications approved by the City pursuant to subsection 4.5 below.

Property: The Oliver Property and the Oriental Property as assembled for the Project as contemplated in the Agreement and also sometimes referred to as the Site.

Public Benefits Agreement: That certain agreement to be entered into between the City and Developer in connection with the Agreement substantially in the form attached hereto as Exhibit L.

Redevelopment Documents: The Redevelopment Plan, the Guidelines and the TIF Plan. The Redevelopment Documents shall include any revision made from time to time by the City, provided that no such revision shall: (i) alter the use of the Site for the purposes contemplated by the Agreement; (ii) substantially alter the schedule for Completion of the Project; or (iii) expressly require Developer to take any action or imposes on Developer an obligation that results in a material increase in the overall development costs of the Project or Developer's share thereof.

Redevelopment Project Costs: Redevelopment project costs as defined in Section 5/11-74.4-3(q) of the TIF Act, as amended from time to time.

Related Agreements: The Agreement to Provide Assistance to the Chicago School Reform Board of Trustees, the Mortgage and the Public Benefits Agreement.

Schedule: The schedule for the dates of completion of the various Project activities, described on Exhibit R attached

hereto, as the same may be revised and updated from time to time pursuant to the provisions of the Agreement.

Site: That certain real property described in Exhibit A attached hereto. The Site shall consist of the Oliver Property and the Oriental Property.

Specialty Contracts: Those certain contracts, other than Component Contracts, approved by the DPD which are entered into by Developer or the Architect to undertake certain of the activities constituting the Project.

Specialty Work: The work associated with a particular Component and undertaken pursuant to an executed Specialty Contract, and defined as such in subsection 4.5(b).

Subsequent Developer: That certain entity which shall acquire the Site from the City in the event of a breach by Developer as more specifically described in subsections 5.3(d) and (e) below.

Title Company: Chicago Title Insurance Company, or such other title company mutually selected by the parties in accordance with the terms and conditions of the Agreement.

Term of the Agreement: The period for which the Agreement is in effect pursuant to the TIF Ordinances (through and including March 1, 2007).

Working Drawings and Specifications: Collectively, the final working drawings and specifications for the various Components of the Project, which have been approved by the DPD.

SECTION I

INCORPORATION OF RECITALS AND DEFINITIONS

The recitals and definitions set forth above constitute an integral part of the Agreement and are hereby incorporated herein by this reference with the same force and effect as if set forth herein as agreements of the parties.

SECTION II

COVENANTS, REPRESENTATIONS AND WARRANTIES

2.1 Covenants, Representations and Warranties of Developer.

To induce the City to execute the Agreement and perform the obligations of the City hereunder, Developer hereby covenants, represents and warrants to the City as follows:

- (a) Developer is a duly organized and existing Delaware corporation in good standing under the laws of the State of Illinois, and is a wholly-owned subsidiary of Livent.
- (b) No litigation or proceedings are pending or, to the best of Developer's knowledge, are threatened against Developer or any Affiliate of Developer which could: (i) affect the ability of Developer to perform its obligations pursuant to and as contemplated by the terms and provisions of the Agreement, the Redevelopment Documents and the Related Agreements; or (ii) materially affect the operation or financial condition of Developer.
- (c) The execution, delivery and performance by Developer of the Agreement have not constituted or will not, upon the

giving of notice or lapse of time, or both, constitute a breach or default under any other agreement to which Developer or any Affiliate of Developer is a party or may be bound or affected, or a violation of any law or court order which may affect the Site, any part thereof, any interest therein or the use thereof.

- (d) The parties executing the Agreement and the Related Agreements on behalf of Developer have been duly authorized by all appropriate action to enter into, execute and deliver the Agreement and the Related Agreements and perform the terms and obligations contained therein.
- (e) To the best of its knowledge, the intended use of the Site by Developer does and shall not violate: (i) any statute, law, regulation, rule, ordinance or executive or judicial order of any kind (including, without limitation, zoning and building laws, ordinances, codes or approvals and environmental protection laws or regulations); or (ii) any building permit, restriction of record or any agreement affecting the Site or any part thereof.
- (f) Except as otherwise provided in the Agreement, and specifically as described in subsection 4.15 below, prior to the issuance of the Certificate Developer shall not, without the prior written consent of the DPD, which the DPD may withhold in its reasonable discretion: (i) be

a party to any merger, liquidation or consolidation; (ii) sell, transfer, convey, lease (excepting the retail portion of the Project, the merchandising activities associated with the box office and the food and beverage facilities serving patrons of the Oriental Theater) or otherwise dispose of all or substantially all of its assets or any portion of the Oliver Property or Oriental Property except in the ordinary course of business; (iii) grant, suffer or permit any lien, claim or encumbrance upon the Site or any portion thereof; (iv) permit or suffer any levy, attachment, claim or restraint to be made affecting the Site or any portion thereof; or (v) enter into any transaction not in the ordinary course of business of Developer, which materially or adversely affects Developer's ability to pay its debts as such may then exist or mature.

- (g) Developer shall utilize the Project solely for those uses permitted by the terms of the Agreement, the Redevelopment Documents and the Related Agreements.
- (h) Developer shall comply with the terms of: (1) the Affidavits; (2) the Employment Opportunity Obligations described in Section VI of the Agreement; (3) the Public Policy Covenants described in subsection 7.1 below; (4) the Covenant of Performance; (5) the Public Benefits Agreement; (6) the Agreement to Provide Assistance to the Chicago School Reform Board of Trustees; and (7) the job

creation, retention and other requirements described in subsection 7.3 below.

- (i) Developer shall renovate, rehabilitate and preserve the facade of the Oliver Building as needed from time to time to complete the Project and to preserve its historic and architecturally significant features in accordance with the Landmarks Ordinance and the Preservation Easement, and, as applicable, in accordance with the Working Drawings and Specifications (as defined in subsection 4.5 below) approved by the DPD and the Landmarks Commission.
- (j) Developer shall use the Site for the presentation of live theatrical, cultural and entertainment activities and other uses not incompatible therewith, including, without limiting the generality of the foregoing, public and private conferences, seminars, corporate and other business meetings, convocations, retail, restaurants, commercial services, rehearsals and ancillary uses.
- (k) Developer shall operate the Oriental Theater to be located at the Site in accordance with the standards of a first class live theatrical organization, provided that Developer shall possess full artistic freedom in the presentation of theatrical, cultural and entertainment activities at the Oriental Theater.
- (l) Developer shall fully keep, observe and perform its obligations and duties under the Option Agreement and keep the same in full force and effect in order to

acquire the Oriental Property for the purposes provided in the Agreement.

2.2 Representations and Warranties of the City.

To induce Developer to execute the Agreement and perform the obligations of Developer hereunder, the City hereby represents and warrants to Developer that the City has authority under its home rule powers granted in the Constitution of the State of Illinois to enter into, execute, deliver and accept, as the case may be, the Agreement and Related Agreements, and to perform any and all of its obligations thereunder.

2.3 Survival of Representations and Warranties.

Developer agrees that all of its representations and warranties, and the City agrees that all of its representations and warranties, set forth in this Section II or elsewhere in the Agreement are true as of the execution date of the Agreement and will be true at all times hereafter during the Term of the Agreement, except with respect to matters which have been disclosed in writing to and approved by the other party.

SECTION III

CONVEYANCE OF THE OLIVER PROPERTY

3.1 Acquisition of Oliver Property by the City. The City, subject to any Permitted Delays as provided in subsection 5.2, shall use its best efforts to acquire (by eminent domain proceedings if necessary) fee simple title to the Oliver Property and to terminate all tenant occupancies, including the relocation

of the existing tenants in accordance with its customary policies and procedures for acquisitions in the North Loop. The parties acknowledge, however, that the leasehold of the State of Illinois ("State") may not be acquired as a result of the eminent domain proceeding without the consent of the State. The City intends to utilize "quick-take eminent domain proceedings" if necessary to acquire the Oliver Property free of all ownership and possessory rights of others, and to obtain the consent of the State to the termination of any possessory rights it may have, and to afford tenants a reasonable time to vacate. In the event that the City is unsuccessful in acquiring the Oliver Property as described in this subsection 3.1 by May 20, 1996, the parties agree to be bound by the terms and conditions described in Section 4.1 below.

3.2 Form of Deed. The City shall convey to Developer fee simple title to the Oliver Property by quitclaim deed substantially in the form attached hereto as Exhibit B ("Deed"). The conveyance and title shall, in addition to the provisions of the Agreement, be subject to:

1. Covenants and restrictions set forth in the Deed.
2. The Redevelopment Documents affecting the Property for the Term of the Agreement.
3. The permitted exceptions described in Exhibit C attached hereto as disclosed by an ALTA owner's title insurance commitment or policy.
4. Taxes for the current year not then due and owing.
5. Title objections caused by Developer.

In addition, the Oliver Property shall be conveyed to Developer "AS IS" and "WHERE IS", and with no warranty, express or implied, by the City as to the condition of the soil, its geology, or the presence of known or unknown faults, or to the physical and environmental condition of any improvements located thereon. It shall be the sole responsibility of Developer to investigate and determine the soil and environmental condition of the Oliver Property. If the soil and environmental conditions of the Oliver Property are not in all respects entirely suitable for the use or uses to which the Oliver Property are to be utilized in conjunction with the Project, then it shall be the sole responsibility and obligation of Developer to take such action as may be necessary to place the soil and environmental condition of the Oliver Property in a condition entirely suitable for the intended Project.

3.3 Conveyance of the Oliver Property. Subject to all the terms, covenants and conditions of the Agreement, at closing on the Oliver Property Closing Date (as hereinafter defined) the City shall convey to Developer the Deed to the Oliver Property subject to the occurrence of all of the following in accordance with the applicable provisions of the Agreement:

- (a) approval by the DPD and the Landmarks Commission of Developer's Schematics and Design Plans (as defined in subsection 4.5(a) below, unless the City agrees that such approval may occur at a later time in accordance with the approval provisions of said subsection 4.5(a)); and

- (b) approval by the DPD of the Schedule for the Project, as more fully described in subsection 4.7(a) below; and
- (c) approval by the DPD of Developer's Budget as defined in subsection 4.8(a)(2) below and the deposit of Developer's Equity and satisfactory demonstration by Developer to the City of the availability of Developer's Financial Contribution for deposit in the Escrow as described in subsections 4.8(a)(2) and 4.8(c) below; and
- (d) receipt by the DPD of the Completion Guaranty from Livent, substantially in the form attached hereto as Exhibit Q; and
- (e) approval by the DPD of the Loan Agreement, if any, as more fully described in subsection 4.8(a)(1) below in furtherance of satisfying Developer's Financial Contribution; and
- (f) the obtaining by Developer of insurance policies insuring the Site as more fully described in subsection 4.14 below; and
- (g) unless otherwise provided for in subsection 4.1 below, the acquisition by Developer of the Oriental Property.

The "Oliver Property Closing Date" shall be the date designated for closing of the conveyance of the Oliver Property by the City to Developer in a written notice from the City to the Developer that shall not be less than ten (10) nor more than thirty (30) days from the giving of such notice after the City has acquired the Oliver Property.

3.4 Closing Documents. At the closing for the Oliver Property, the parties shall deliver to each other the following:

(i) Developer's documents:

(a) A certificate of good standing and a certificate of incumbency for Developer.

(b) A corporate resolution from Developer authorizing the acceptance of the conveyance.

(c) An ALTA statement.

(ii) The City's documents:

(a) The Deed.

(b) A Bill of Sale, if applicable.

(c) A certified copy of the ordinance adopted by the City Council of the City authorizing the City to enter into and perform the Agreement and to execute the Agreement and all other documents necessary to carry out the transactions provided for in the Agreement.

(d) An ALTA statement.

3.5 Title Insurance and Survey. In connection with the conveyance of the Oliver Property by the City to Developer, the City, at Developer's sole expense, shall provide to Developer (i) a policy of title insurance from the Chicago Title Insurance Company or other title company mutually agreeable to the parties ("Title Company"), consisting of an Owner's Policy ALTA form B (1987), dated as of the date of recording with the Recorder's Office of the deed conveying the Oliver Property to Developer, insuring the title of Developer with regard to the Oliver Property,

subject only to the reservations and exceptions provided in this Section III, and (ii) a survey of the Oliver Property meeting joint ALTA/ASCM requirements certified to the Title Company, Developer and the City and containing a flood plain certification. Developer, at Developer's sole expense, may obtain such endorsements as it may require. The City agrees to use reasonable efforts to assist Developer in the obtaining of said endorsements.

3.6 Real Estate Taxes. Developer shall be responsible for real estate taxes accruing after the conveyance of said Deed.

3.7 Recordation of Deed. Developer shall promptly file the Deed for recordation with the Recorder's Office. Developer shall bear all such recording costs as Developer's sole expense.

SECTION IV

THE CONSTRUCTION OF THE PROJECT

4.1 Assembling the Site. The parties acknowledge and agree that both the Oliver Property and the Oriental Property are to be acquired for the Project. As of the execution date of the Agreement, the City will have commenced steps to acquire the Oliver Property in accordance with the terms and conditions of subsection 3.1 above.

Developer presently possesses the right to acquire fee simple title to the Oriental Property pursuant to the terms and conditions of the Option Agreement (a true, correct and complete certified copy of which has been furnished by Developer to the City) under circumstances that will permit Developer, upon acquisition of the

Oriental Property and conveyance of the Oliver Property by the City to Developer, to proceed with the Project in the manner provided for in the Agreement. In that regard, Developer represents and warrants to the City that the Oriental Property can be legally severed from the larger 32 West Randolph Street Building (the "32 Building") by vertical subdivision or other acceptable means, the owner of the 32 Building has informed Developer that it has obtained from the lender having a mortgage on the 32 Building the Consent to Sell and Approval to Discharge as relates to the Oriental Property and the parties have agreed in principal to the terms and conditions of the Reciprocal Rights Agreement, all as contemplated in and required under the Option Agreement. Developer has provided to the City written evidence regarding the matters set forth in the preceding sentence, all of which are subject to the approval of the City. Notwithstanding anything to the contrary contained in the Agreement, in no event is the City obligated to advance or reimburse Developer for the option price for the Oriental Property (being the total of \$3,800,000), unless the City has approved said acquisition in writing as being in compliance with the Option Agreement and consistent with the Agreement.

If, by May 20, 1996, the City has acquired title to the Oliver Property and has obtained the requisite consent of the State to terminate its possessory interest therein, Developer shall exercise its right under the Option Agreement to acquire the Oriental Property prior to the expiration of the term of the Option Agreement, being June 6, 1996, unless subsequently extended with

the consent of the City, and schedule a closing in accordance with the applicable provisions of the Option Agreement.

If, however, by May 20, 1996, the City has not acquired title to the Oliver Property, but has filed an eminent domain suit to do so and is diligently proceeding to prosecute said suit as previously described and its authority therefore has been affirmed, and there has been no ruling made or order entered by the court, and the State has indicated to the City its willingness to surrender its leasehold interest in the Oliver Building in a time frame acceptable to the City and Developer, then the City shall deliver written notice of such to Developer. Developer shall thereupon proceed to acquire title to the Oriental Property through the exercise of its right under the Option Agreement, unless at Developer's sole expense, Developer timely obtains (or shall have obtained) an extension of the term of the Option Agreement. In such event, the parties shall mutually agree on a revised Project schedule; provided, however, if the City after proceeding diligently remains unsuccessful in acquiring title to the Oliver Property by June 30, 1996, where the term of the Option Agreement has been extended to at least cover such period, then the Agreement, by written notice from either party delivered to the other, may be terminated, and the parties shall be under no further obligation to each other.

If, however, by May 20, 1996, the City has not required the exercise of the option under the Option Agreement as provided above, but the City is proceeding diligently with regard to any

pending eminent domain proceedings, then the City shall deliver written notice of such to Developer. In such event, Developer, at its sole expense, shall be obligated to use its best efforts (not involving the expenditure of additional money) to negotiate an extension of the term of the Option Agreement. In the event such an extension is not obtained and the Option Agreement expires, the Agreement shall terminate and the parties shall be under no further obligation to the other. In the event that such an extension is obtained, the parties shall thereafter mutually agree on a revised Project schedule; provided, however, if the City after proceeding diligently remains unsuccessful in acquiring the Oliver Property by June 30, 1996 where the term of the Option Agreement has been extended to at least cover such period, then the Agreement, by written notice from either party delivered to the other, may be terminated, and the parties shall be under no further obligation to each other.

At the closing for the conveyance of the Oriental Property to Developer pursuant to the Option Agreement (the "Oriental Property Closing Date"), Developer shall deposit with the Escrowee (as defined below) under suitable escrow instructions a warranty deed ("Oriental Deed") from Developer to the City for the Oriental Property, together with all necessary transfer declarations, title company affidavits and consents and approvals of third parties, which Oriental Deed shall be recorded, at the election of the City, in the event of a default as described in subsection 5.3 below. Subject to the terms of the Agreement, to the extent possible and

practicable, the parties shall try to coordinate the Oliver Property Closing Date and the Oriental Property Closing Date to occur concurrently.

4.2 The Project. The Project that shall be constructed by Developer at the Site shall consist of the Oriental Theater and approximately 7,000 square feet of retail space compatible with the operation of a first class theater. The Project shall also include the renovation and/or rehabilitation, as needed, of the facade of the Oliver Building to preserve its historic and architecturally significant features in accordance with the Preservation Easement and the status of the Oliver Building as a designated City landmark and, as applicable, in accordance with the Working Drawings and Specifications approved by the DPD and the Landmarks Commission in accordance with the procedures described in subsection 4.5 below.

The use of the Project shall be limited to those activities which are more fully described in subsection 2.1(j) above, and shall be operated by Developer in accordance with the standard of a first-class live theatrical organization. This restriction on use provision shall also be contained in the Deed and, subject to the provisions contained in subsections 5.3(d) and (e) below, shall be considered to be a covenant running with the land during the Term of the Agreement to the full extent allowable under Illinois law.

4.3 The Project's Development Parameters. The Project shall be constructed substantially in accordance with the Working

Drawings and Specifications (as defined in subsection 4.5 below), and shall be subject to the following development parameters:

- (a) Developer's Schematics, a reduced copy of which is attached hereto as Exhibit D, setting forth the intended scope of the Project, and a narrative description of the Project, have been approved by the DPD.
- (b) The facade of the Oliver Building shall be preserved by Developer in accordance with the terms of the Agreement, including, without limitation, subsection 4.2 above and Exhibit P attached hereto. The area between the rear wall of the Oriental Theater and the facade shall be utilized as plenum, mechanical and shaft space, stairs and structure and may contain pipes, conduit, stairs and building services.
- (c) The facade of the Project along the Randolph Street right-of-way shall be consistent with the Schematics and be active and pedestrian-oriented in character to the extent agreed upon by the parties. The Randolph Street facade shall include the re-creation of the Oriental Theater marquee. Emergency exit doors for the Oriental Theater shall be provided via the Couch Place public alley located north of the Site, and through the main theater entrance and the 32 West Randolph Street Building entrance, both being on West Randolph Street. Emergency exit doors for the Oriental Theater shall not be through the retail portions of the Project.

- (d) The exterior canopy and signage utilized by Developer (including the Oriental Theater marquee described in subparagraph (c) above) located at the Project shall be consistent with the Design Plans and shall meet the prior written approval of the DPD.
- (e) Loading access to the Project (other than retail) shall occur solely from Couch Place. Deliveries may be made to the retail facilities from Randolph Street.
- (f) Any streetscaping, including any paving of sidewalks, landscaping and lighting, provided by Developer as part of the Project shall meet the prior written approval of the DPD and be attractive and compatible with the streetscaping of Block 36.

4.4 Right of Entry. If necessary, and if and when the City has the right and authority to do so, the City shall grant to Developer a right of entry to the Oliver Property for the purpose of allowing Developer's architects and engineers to inspect the Oliver Property and to investigate the soil and the environmental condition existing in the Oliver Property at Developer's sole risk; provided that Developer provides to the City such insurance protection in connection therewith as deemed appropriate by the City's Risk Manager and that Developer shall be deemed to indemnify and hold harmless the City regarding any such activities. From such inspections, Developer shall utilize the information obtained when preparing its Design Plans and the Working Drawings and Specifications (as such are defined in subsection 4.5 below) as

well as the Budget described in subsection 4.8(a) below for the Project.

4.5 Submission of Construction Documents; Environmental Review.

(a) **Design Plans.** Developer's preliminary schematic drawings ("Schematics"), describing any proposed renovation and/or rehabilitation, as needed, of the facade of the Oliver Building and the development of the other Project improvements to be constructed at the Site, have been approved by the Landmarks Commission and the DPD and reduced copies of which are attached hereto as Exhibit D. Within sixty (60) days of the acquisition by Developer of the Oriental Property or the Oliver Property, whichever is later, Developer shall prepare and submit to the Landmarks Commission and the DPD for their respective approval proposed design development plans for the Project based upon and consistent with the Schematics. The design development plans shall also conform to the terms of the Agreement, the Redevelopment Documents, as amended from time to time, the Landmarks Ordinance and the Preservation Easement (when applicable), and all applicable state and local laws, ordinances and regulations. The Landmarks Commission and the DPD shall have fifteen (15) days in which to approve or reject the design development plans. If the Landmarks Commission or the DPD, or both, reject the design development plans, the Landmarks Commission or the DPD, as the case may be, shall deliver written notice of such to Developer. Developer shall thereafter have fifteen (15) days in order to revise them

consistent with the requirements of the Landmarks Commission or the DPD, as the case may be, and resubmit them to the Landmarks Commission and the DPD for approval. The City shall thereafter have ten (10) days upon receipt from which to review or reject the resubmitted documents.

Developer's final design development drawings and specifications which have been approved by the DPD and the Landmarks Commission, as applicable, shall be considered the "Design Plans" for purposes of the Agreement.

Any material change to the Design Plans must be submitted to the Landmarks Commission and the DPD for their approval, which approval shall not be unreasonably withheld or delayed.

(b) Development of Working Drawings and Specifications. The parties acknowledge that the Project is intended to be constructed on a "fast track" basis, but in a high quality, timely and efficient manner interrelated on a logical basis to achieve the completion of the Project in accordance with the Schedule, as the same may have been amended and modified by Developer in light of the Design Plans or as a result of any other applicable provisions of the Agreement, any such amended Schedule to be approved by the DPD in accordance with Section 4.7(a) below.

Each of the Project activities described on Exhibit S attached hereto (whether referred to as Component Work or Specialty Work, as such terms are defined below) shall be constructed based on final working drawings and specifications for such work which have been produced by or on behalf of Developer in accordance with

the Design Plans, the terms of the Agreement, the Redevelopment Documents, as amended from time to time, the Landmarks Ordinance and the Preservation Easement (when applicable), and all applicable state and local laws, ordinances and regulations, and meet with the approval of the DPD and the Landmarks Commission. For purposes of the Agreement, the working drawings and specifications corresponding to each such Project activity shall be individually referred to as a "Component" and collectively as "Components". The work, labor and materials corresponding to a particular Component undertaken by a Contractor which is coordinated and supervised by a Construction Manager in accordance with Section 4.7 below shall be referred to as "Component Work", while the work, labor and materials corresponding to a particular Component which is undertaken by a Contractor pursuant to a Specialty Contract which is coordinated and supervised by Developer or the Architect shall be referred to as "Specialty Work".

The Components shall be completed in sufficient detail by Developer and delivered to the DPD and the Landmarks Commission for review and approval and in a sequence sufficiently coordinated to allow for their submittal to the City's Department of Buildings and Landmarks Commission for the issuance of building permits. Each Component shall be accompanied by a written narration from the Architect describing any material difference between the particular Component and the Design Plans. Upon receipt, the DPD shall have fifteen (15) days in which to approve or reject the Component in question based on whether it is consistent with, or materially

varies from, the Design Plans with regard thereto. If the DPD rejects the Component in question that varies materially in a manner that it finds unsatisfactory, the Developer shall cause such unsatisfactory Component to be timely revised for delivery and approval by the DPD. The City shall thereafter have ten (10) days upon receipt from which to review or reject the resubmitted documents. A final set of each of the various Components (which has been approved by the DPD) shall be maintained at the Site by Developer, shall be identified to the Agreement in a amendment to Exhibit D attached hereto, and shall collectively constitute the final Working Drawings and Specifications for purposes of the Agreement.

Any material change to any of the Working Drawings and Specifications for any Component must be submitted to the DPD for its approval, which approval shall not be unreasonably withheld or delayed.

(c) Environmental Review. Not less than thirty (30) days prior to the commencement of construction of the Project, Developer shall have provided the DPD with copies of a suitable Phase I environmental audit of the Site. Based on the City's review thereof, the City may, in its sole discretion, require the completion of a Phase II environmental audit with respect to the Site prior to the commencement of construction. If any such audit discloses Hazardous Materials at the Site, then it shall be Developer's sole responsibility to undertake such environmental remediation or corrective work as necessary to place the

environmental condition of the Site in a condition entirely suitable for the intended Project and in compliance with Environmental Laws.

4.6 Limited Applicability of DPD's Approval. Any approvals of the Schematics and the Working Drawings and Specifications made by the DPD are for the purposes of the Agreement only and do not affect or constitute approvals required for building permits or approvals required pursuant to any other ordinance of the City, nor does any approval by the DPD pursuant to the Agreement constitute approval of the quality, structural soundness or the safety of the improvements constituting the Project. The City, however, agrees to assist Developer in expeditiously obtaining approvals for building permits affecting the Project. Developer agrees to notify the DPD within five (5) days of the issuance of any building permit by the City's Department of Buildings.

4.7 Construction Schedule; Hiring of Contractors; Performance Bond; Purchase of Materials.

(a) **Developer's Construction Schedule.** Developer's preliminary schedule ("Schedule") for the commencement and completion of the Component Work and Specialty Work constituting the Project has been approved by the DPD and is attached hereto as Exhibit R. In conjunction and with respect to the production by Developer of the Design Plans (as described in Section 4.5 above), Developer shall prepare and submit to the DPD for its approval a revised Schedule describing in more accurate detail from the preliminary Schedule a timetable for the commencement and

completion of the Component Work and the Specialty Work constituting the Project. The Schedule shall be subsequently revised by Developer and submitted to the DPD on a quarterly basis during the construction of the Project.

(b) Demolition Contractor. In preparation for the redevelopment of the Site in conjunction with the terms of the Agreement, Developer or the Construction Manager, as the case may be, shall hire a qualified demolition contractor ("Demolition Contractor") meeting the prior approval of the DPD to undertake the Component Work corresponding with the selective demolition of portions of the Oliver Building and the Oriental Property, the providing of temporary and ongoing structural support and shoring made necessary by such demolition and any necessary environmental remediation of the Site (collectively, the "Demolition Component Work") in accordance with the approved Component(s). With regard to the selection of the Demolition Contractor, Developer or the Construction Manager, as applicable, shall solicit bids from at least three (3) qualified contractors from a list of contractors which has been submitted by Developer and pre-approved by the City. Developer or the Construction Manager shall seek to hire a Demolition Contractor at the lowest cost practicable in light of the objectives for the construction of the Project as expressed in the Agreement. The demolition contract ("Demolition Contract") shall include provisions that the Demolition Contractor shall be bound by the rules, laws, regulations and provisions described in subsection 4.7(c) below.

The Demolition Component Work shall not commence until the DPD has approved the terms of the Demolition Contract and any other Contracts with respect to the Demolition Component Work. The Demolition Component Work shall proceed in accordance with the Schedule for the Project as approved from time to time. The Demolition Contract must specifically require in its terms for the delivery by the Demolition Contractor to the DPD and Developer of the dump ticket issued at the disposal site, prior to the receipt by the Demolition Contractor of any final payment due and owing under said Demolition Contract, and shall further provide for the retention of ten percent (10%) of funds until the final completion of the Demolition Component Work to the satisfaction of Developer and the DPD. In addition, the Demolition Contractor and any other Contractor performing Demolition Component Work may be required (at the option of the DPD) to deliver to the DPD payment and performance bonds designating the City as an additional beneficiary in the amount of the Demolition Contract and any such other Contracts. The bonds shall be issued by a reputable company satisfactory to the DPD in its reasonable discretion and shall otherwise meet the requirements of subsection 4.7(d).

(c) Hiring of Construction Manager Subsequent to Completion of Demolition Component. As the various Components relating to the Component Work (other than the Demolition Component Work) are completed by Developer and approved by the DPD, Developer shall revise the Schedule accordingly, and hire a Construction Manager to undertake the construction of the various Component Work, when

ready to do so and in accordance with the Schedule, constituting the Project. The Construction Manager may be the same entity, or a different entity from that, employed with regard to the completion of the Demolition Component Work. With regard to the selection of the Contractor or Contractors hired to undertake the completion of the various Component Work or Specialty Work, Developer or the Construction Manager shall solicit bids from at least 3 qualified contractors per Component or combination of Components, being contracted for at the same time, from a list of contractors previously submitted by Developer and approved by the DPD and which may include the Construction Manager. Developer shall seek to hire a contractor at the lowest cost practicable in light of the objectives for the construction of the Project as expressed in the Agreement. With regard to the hiring of subcontractors by a Contractor to undertake the construction of the pertinent Component Work or Specialty Work, such Contractor shall solicit bids from at least 3 qualified subcontractors to undertake the pertinent work. The subcontractors may be selected from a list of subcontractors submitted by Developer and approved by the DPD.

All solicitations of bids by Developer or its Construction Manager shall require that all Contractors (and the subcontractors thereof) comply with: (i) the Equal Employment Opportunity provisions described in subsection 6.1 below; (ii) the Chicago Resident Employment Ordinance provisions described in subsection 6.2 below; (iii) the Veteran Preference Act, 330 ILCS 55/11 et seq. (1993); (iv) the terms and provisions of the Chicago Human Rights

Ordinance, Section 2-160-010 et seq., Municipal Code of Chicago; and (v) the Prevailing Wage Act of Illinois, 820 ILCS 130/1 et seq. (1993).

Notwithstanding the foregoing provisions of this subsection 4.7(c), Developer may enter into a negotiated contract with a particular Contractor regarding certain of the Specialty Work. Such contractor shall be selected from a list submitted by Developer and approved by the DPD. Appropriate factors to be considered in the letting of the Specialty Contract, but without limitation as to other appropriate factors, are peculiar or particular qualifications of the contractor or subcontractor considering the nature of the subject work, time constraints or the specialized nature of certain work to be performed.

The DPD shall evaluate the prospective bids within seven (7) days of their submission by Developer. Developer or its Construction Manager shall thereafter select the pertinent Contractor submitting the lowest responsible bid in light of the objectives of the Agreement, in connection with the execution of the contract between Developer and the Contractor in question ("Component Contract") (or in the case of Specialty Work, a "Specialty Contract"). True, correct and complete copies of all executed Component Contracts, Specialty Contracts and all subcontracts entered into by a pertinent Contractor with its subcontractor ("Subcontracts") shall be delivered to the DPD. Each Component Contract, Specialty Contract and Subcontract shall comply with the requirements of the Agreement.

Each Component Contract, Specialty Contract, and Subcontract, must contain provisions: (i) regarding compliance with the laws and regulations described in this subsection and in the Agreement; (ii) naming the City as a third party beneficiary and an assignee; and (iii) obligating the Contractor, Specialty Contractor or any Subcontractor, to furnish such reports and information as requested by the Chicago Commission on Human Relations to determine compliance with the Chicago Human Rights Ordinance.

Generally, Project Work shall not commence with regard to any Component Work or Specialty Work until the pertinent Component Contract or Specialty Contract is let, and an appropriate payment and performance bond, if required by the City in accordance with Subsection (d) below, is obtained. Each Component Contract and Specialty Contract shall utilize the form of contract previously approved by the DPD, and which contains a general reference to the Agreement and specific references to the City's requirements described in this Section 4.7

Notwithstanding the foregoing, work may commence with regard to a particular Component Work or Specialty Work prior to the execution of the pertinent Component Contract or Specialty Contract, but only in the event that: (1) such work has been obtained from a contractor pursuant to a Memorandum of Understanding ("MOU"), which MOU shall be in the form of MOU previously approved by the DPD and referencing the particular Component approved by the DPD, and including the form of contract which has also been previously approved by the DPD; (2) the MOU

should specifically alert Contractor of the City's requirements described in this Section 4.7; (3) a suitable payment and performance bond is obtained to the satisfaction of the DPD, if so required of the particular Component Work or Specialty Work pursuant to the Agreement, either from the pertinent contractor, the Construction Manager or Developer; and (4) the DPD and the Inspector are notified in writing prior to the commencement of such work. In no event, however, shall the provisions contained in this paragraph relieve the Developer of its obligations to provide copies of all contracts to the DPD for its prior approval or to otherwise relieve Developer, its Construction Manager, Demolition Contractor, Component Contractor, or Specialty Contractor, as the case may be, to comply with the bonding requirements described in subsection 4.7(d) below.

Except as provided below, any modifications, change orders or amendments to any Component Contract or Specialty Contract shall be described in a written report provided by Developer to the City on a monthly basis in conjunction with a Request for Advance (as defined in subsection 4.8(c)(3)(d)) pursuant to the Escrow. The monthly report shall describe any resulting increase in costs (real or estimated) on a line item basis resulting from such change order, modification or amendment. The scope of review and approval of said modifications, change orders, or amendments by the DPD shall be based solely on how they affect: (i) the amounts available as contingency in the Budget; (ii) any transfers between line items of the Budget; (iii) an analysis of the overall Budget

for the Project and the amount of undisbursed financial resources available to complete the Project in accordance with the Agreement; and (iv) a material change in scope from the approved Component. In the event that the City, in its reasonable discretion, believes that the amount of remaining contingency is insufficient, given the uncompleted portion of the Project as of the date of the written report, or that the amount of funds available to Developer to complete the Project is insufficient, then Developer, within ten (10) days of written notice, shall be required by the City to deposit such required sums in Escrow or otherwise to identify to the City other funds to be made available as contingency or otherwise to complete the Project. Notwithstanding the above language, any approved modification, change order or amendment shall not be deemed to imply any obligation on the part of the City to increase the amount of the City's Financial Contribution.

Within fifteen (15) months of the commencement of the construction of the Project as evidenced by the issuance of the first building permit for the completion of the Demolition Component Work, Developer shall enter into an agreement with its Construction Manager that shall be inclusive of and wraparound all Component Contracts for Component Work (as opposed to Specialty Work) theretofore and thereafter to be entered into through such Construction Manager that establishes a "guaranteed maximum price" therefor necessary to complete the Project (the "GMP Contract"). The GMP Contract shall be subject to the prior approval of the DPD.

(d) **Bonds.** In addition, unless otherwise agreed to by the DPD, each Contractor or Specialty Contractor shall be required to deliver to the City payment and performance bonds designating the City as a beneficiary in an amount no less than the amount of construction costs as reflected in the particular Component Contract or Specialty Contract, as the case may be, insuring the undertaking of the construction of the particular work in accordance with the particular Component and consistent with the provisions of the Agreement. Said payment and performance bonds shall be issued by a reputable company satisfactory to the DPD in its reasonable discretion having an AA rating or better using American Institute of Architect's Form No. 311 or its equivalent.

(e) **Purchase of Materials.** All materials utilized with regard to the construction and completion of the Project, whether purchased directly by Developer, or by any Contractor, Specialty Contractor or Subcontractor, shall be new (unless otherwise provided in the approved Component), high quality materials acquired at the lowest practicable cost. Developer intends to use or re-use, when practical, certain materials or historic fabric found at the Site.

4.8 Financing the Project.

(a) **Budget and Developer's Financial Contribution; Establishment of Construction Schedule.**

(1) **Developer's Financial Contribution.** As of the execution date of the Agreement, the total Project costs including the cost of acquisition in the amount of Three Million Eight

Hundred Thousand Dollars (\$3,800,000) to be provided as part of the City's Financial Contribution for the Oriental Property and the Seven Hundred Thousand Dollars (\$700,000) to be provided as part of the City's Financial Contribution for the Demolition Component Work ("City's Pre-Development Contribution") and excluding the acquisition and relocation costs to be undertaken by the City in connection with the Oliver Property (the "Oliver Acquisition Contribution") are estimated to be Twenty Eight Million Five Hundred Thousand Dollars (\$28,500,000) plus the Oliver Acquisition Contribution. Of this aggregate sum, Developer shall provide funds to pay for certain costs associated with the Project (such funds to be described as "Developer's Financial Contribution"), estimated to be Fifteen Million Dollars (\$15,000,000); provided, however, that Developer shall be solely responsible for all Project cost overruns beyond the City's Financial Contribution for certain Redevelopment Project Costs in accordance with the Budget.

No later than April 10, 1996, Developer shall deposit with or deliver to the City for subsequent delivery to the Escrowee once the Escrow is created by the parties pursuant to subsection 4.8(c) below, as part of Developer's Financial Contribution, the sum of Five Million Dollars (\$5,000,000) as equity ("Equity"), either in the form of cash or a direct-pay letter of credit, the terms of which shall meet the prior approval of the City and such Escrowee. Such sum may be offset and reduced for approved prior expenditures based on documentary evidence satisfactory to the DPD, in its reasonable discretion, that Developer has previously expended

monies to satisfy certain Project costs as are reflected in the approved Budget. The DPD reserves the right, in its reasonable discretion, to disallow any such expenditure as a prior expenditure. In addition, Developer shall provide satisfactory evidence to the City no later than the Oliver Property Closing Date that it has obtained irrevocably committed funds or financing for the balance of Developer's Financial Contribution, including, without limitation, the allocation of funds derived from the proceeds of that certain stock issue by Livent Inc. recently concluded.

With regard to accumulating the Developer's Financial Contribution, Developer also shall be permitted to obtain a loan secured by the Property ("Lender Financing") from a reputable financial institution or other lender which is in good standing with the State of Illinois, or in the alternative, for those financial institutions not licensed to do business in the State, in compliance with applicable law, and satisfactory to the DPD in its reasonable discretion ("Lender"). In connection with any Lender Financing, Developer shall deliver to the DPD evidence of a commitment for adequate financing ("Commitment"), specifying the amount of Lender Financing, length of the term and the applicable interest rate. The terms of the Commitment shall be subject to the approval of the DPD for the purpose of confirming that it is consistent with the requirements under the Redevelopment Agreement and the Mortgage. Once the Commitment has been approved by the DPD and executed by the parties, the DPD shall also review and approve,

for purposes of confirming that it is consistent with the requirements under the Redevelopment Agreement and the Mortgage, the terms of the loan agreement ("Loan Agreement") regarding the Lender Financing to be executed by Developer and the Lender. The existence of an approved executed Loan Agreement with respect to Lender Financing which will make Lender Financing available for disbursement conditioned only on normal and customary requirements for disbursement of funds from time to time, as opposed to those affecting the Lender's commitment to lend, shall be a requirement to any obligation of the City to disburse any of the City's Financial Contribution. The Lender shall be permitted to secure its loan by a mortgage ("First Mortgage"), or, if needed and obtained, a subsequent mortgage that replaces the First Mortgage, encumbering the Site and evidenced by a mortgage note ("First Mortgage Note"). The First Mortgage shall be superior to any mortgage lien created in favor of the City with respect to Developer's obligation to return the City's Financial Contribution under certain circumstances as described in subsection 4.5(b) below so long as the Lender, at the time of default, agrees to perform, and does perform or causes to be performed the covenants of Developer herein if Developer defaults thereunder or under the Agreement (all as more particularly provided in the Mortgage); subject, however, to the provisions described in subsections 4.16 and 5.3 below. The DPD at its discretion, however, may make modifications to the terms and provisions of the Agreement at the request of Lender; provided, however, that nothing contained in

this Section shall permit the parties to alter the lien position of the respective parties as described in the Agreement. If Developer does not obtain such Lender Financing to satisfy initially its Developer's financial Contribution, it may nonetheless later obtain such Lender Financing as part of refinancing all or any part of Developer's Financial Contribution, subject, however, to the terms and provisions of the Agreement relating to Lender Financing.

Notwithstanding the provisions contained in this paragraph or in the Agreement, Developer shall be permitted to obtain a First Mortgage in an amount not to exceed total Project costs minus the City's Financial Contribution and Equity, it being the obligation of Developer to fund as part of the Developer's Financial Contribution any excess costs of the Project beyond the City's Financial Contribution (whether through Lender Financing, or Equity) and Developer shall hold the City harmless with respect thereto.

In such regard, Developer's ability to fulfill its obligation to provide the funds necessary with regard to the undertaking and Completion of the Project (including the obligation and responsibility for obtaining necessary funds covering all Project cost overruns beyond the City's Financial Contribution for certain Redevelopment Project Costs in accordance with the Budget) shall be supported and guaranteed by that certain Completion Guaranty provided by Livent in favor of the City. The Completion Guaranty shall be executed by Livent in substantial conformity with the form of Guaranty attached hereto as Exhibit Q, and shall be dated as of

the execution date of the Agreement and delivered to the City by Developer.

(2) Budget. Developer's preliminary budget, setting forth the projected and anticipated development costs with regard to the Project, has been approved by the DPD and is attached hereto as Exhibit E ("Budget"), as the same shall be subject to revision as hereinafter provided. Within thirty (30) days after the DPD approves the Design Plans, Developer shall deliver to the DPD for its approval a revised written Budget for the Project, based upon the preliminary Budget, the Design Plans and any architectural and engineering studies undertaken by Developer with regard to the Project and the Site. The Budget shall also contain a description disclosing in sufficient detail any revised information concerning the sources of Developer's Financial Contribution, if any. As the Components are prepared with regard to the undertaking of the Component Work and the Specialty Work, and as the Component Contracts and Specialty Contracts are let, Developer shall be obligated to periodically revise the Budget (on a quarterly basis) and deliver same to the DPD for its approval.

(b) City's Financial Contribution. The City shall make a financial contribution to assist Developer with the completion of the Project in the aggregate amount of Nine Million Dollars (\$9,000,000) for Project renovation ("City's Project Renovation Contribution"), plus the Three Million Eight Hundred Thousand Dollars (\$3,800,000) for the cost of acquiring the Oriental Property, plus the City's Pre-Development Contribution (\$700,000)

and plus the Oliver Acquisition Contribution (collectively, "City's Financial Contribution"). The parties agree that the City's Financial Contribution for eligible Project costs (other than those allocated for the Oliver Acquisition Contribution) shall in no manner exceed the aggregate amount described hereinabove in this paragraph. The parties further acknowledge that the City has reserved funds for the City's Financial Contribution from Incremental Taxes allocated to the City in accordance with the TIF Adoption Ordinance, and that any proposed use of the City's Financial Contribution must be in accordance with any laws, regulations and ordinances governing the use of such funds, including, without limitation, the Illinois Tax Increment Allocation Redevelopment Act, 65 ILCS 5/11-74.4-1 et seq. (1994) ("TIF Act") and, accordingly, must be eligible Redevelopment Project Costs as are defined in Section 5/11-74.4-3 of the TIF Act.

As stated above, the City's Financial Contribution shall be allocated in the following manner: (a) To pay for all Oliver Acquisition Contribution; (b) To pay or reimburse Developer for eligible costs associated with Developer's acquisition of the Oriental Property up to Three Million Eight Hundred Thousand Dollars (\$3,800,000) at the Oriental Closing Date; (c) To pay the City's Pre-Development Contribution of Seven Hundred Thousand Dollars (\$700,000) for the Demolition Component Work; and (d) To pay the City's Renovation Contribution of Nine Million Dollars (\$9,000,000) for costs associated with the construction and renovation of Project improvements, including any restoration

and/or rehabilitation work, as needed, involving the facade of the Oliver Building. Notwithstanding the above, any costs for such activities in excess of the aggregate amount allocated above (except for the Oliver Acquisition Contribution which is to be borne fully by the City) shall be paid for exclusively by Developer. The Redevelopment Project Costs to be paid for by the City or reimbursed to Developer by the City are described more fully on a line item basis in Exhibit F attached hereto. The City's Financial Contribution for the City's Project Renovation Contribution shall be deposited from time to time by the City in a subaccount of the Escrow as needed to cover the Redevelopment Project Costs to be funded therefrom (in such amount as determined on a pro-rata basis in accordance with the Budget) with the Lender Financing proceeds or other Developer private funds or financing) after the disbursement in full of all of Developer's Equity (any Budget savings with respect thereto also to be shared pro-rata by the City and Developer). In making such determination, no portion of the Project costs shall go to pay a development fee to Developer or its Affiliates or for other unsubstantiated Project costs.

The City's Financial Contribution is being made conditioned upon the faithful performance by Developer of the Covenant of Performance, and Use and Performance Covenants provided for in subsection 7.2, which if breached (as described in subsection 5.3(b) below) may result in the obligation of Developer to repay to the City the City's Financial Contribution, all of which obligations shall be secured by that certain mortgage from

Developer in favor of the City ("Mortgage"). The Mortgage shall be dated and delivered as of the earlier of the Oriental Property Closing Date and the Oliver Property Closing Date when the Oliver Property is conveyed by the City to Developer. The terms of the Mortgage and corresponding covenant of performance ("Covenant of Performance") shall be in substantial conformity with Exhibits G and H, respectively, attached hereto. The Covenant of Performance shall be dated as of the date of its delivery to the City in connection with the delivery by Developer of the Mortgage.

In accordance with the terms of the Covenant of Performance and the Mortgage securing same, in the event of default and a failure to cure after the expiration of any applicable cure period, Developer shall be obligated to repay to the City any of the sums of the City's Financial Contribution described in said Mortgage.

Developer agrees that the Mortgage shall be a direct lien and security interest upon the Site. Other than Permitted Exceptions, Developer shall not create or suffer any lien prior to or in parity with the lien of the Mortgage other than the lien created by the First Mortgage (or a replacement First Mortgage) described in subsection 4.8(a) above, all as and to the extent permitted by the Mortgage.

(c) **Construction Escrow.** The Developer's Financial Contribution and the City's Financial Contribution shall be deposited in and disbursed through an escrow account ("Escrow") held by Chicago Title and Trust Company or such other institutional escrowee ("Escrowee") mutually acceptable to the parties, under the

terms and conditions of a customary joint escrow agreement. The respective rights, liabilities and duties of the Escrowee, as well as the purposes for which disbursements may be made from the Escrow and the terms and conditions upon which the same can be made, are contained in the Agreement. The parties agree that as between them if any conflict exists between the terms of the Agreement and any escrow instructions or other documents affecting the Escrow, the terms and provisions of the Agreement shall govern.

1. Permitted Disbursements. At the request of and on behalf of Developer, the Escrowee, pursuant to the terms of the Agreement, shall through disbursements from the Escrow pay directly to the contractor or vendor of Developer or any payee designated by Developer (except to Developer itself with respect to its development fee that is not part of the Budget because no such development fee is allowed to be paid to Developer or any of its Affiliates from the City's Financial Contribution or the Developer's Financial Contribution), including, the Construction Manager, any Contractor, Specialty Contractor or the Demolition Contractor, as the case may be, for eligible Project costs as further described in the Budget. The City's Financial Contribution, however, shall be solely utilized to pay for Redevelopment Project Costs as are more fully described in Exhibit F attached hereto. The City's Financial Contribution and Developer's Financial Contribution shall be deposited with the Escrowee from time to time on an as needed basis to fund permitted disbursements pursuant to the Agreement.

2. Conditions Precedent to Disbursement. Prior to the initial disbursement of funds from the Escrow by the Escrowee (unless a later time is hereinafter contemplated or permitted), Developer shall deliver to the Escrowee the following documents:

- (a) a certificate of good standing from the State of Illinois and the State of Delaware from Developer and from the Province of Ontario, Canada from Livent, along with a corporate resolution of Developer authorizing the execution of the Agreement and the performance of Developer's obligations under the Agreement and a corporate resolution from Livent authorizing it to execute and deliver the Completion Guaranty, together with accompanying certificate of incumbency from Developer and Livent;
- (b) a mortgage title commitment or policy showing: (i) the Mortgage as constituting a lien on the Site subordinate only to any First Mortgage and subject to the Agreement, (ii) the Reciprocal Rights Agreement (as described in Section 4.1 above), and (iii) those permitted exceptions as approved by the DPD;
- (c) a Class A plat of survey (in the most recently revised form of ALTA/ACSM land title survey) of the Site dated within thirty (30) days prior to the commencement of construction of the Project or such earlier date as might be acceptable to the Title Company, prepared and certified by a surveyor licensed in the State of Illinois

showing all easements, encroachments and containing a legal description of the Site, and certified to the City and the Title Company;

- (d) copies of the Demolition Contract, and each Component Contract and Specialty Contract and any Contract with the Construction Manager, if then available and thereafter when obtained, certified by Developer as being a true and complete copy;
- (e) a true copy of the demolition permit and building permits when issued by the City;
- (f) Internal Revenue taxpayer identification numbers of Developer;
- (g) originals of the First Mortgage, if any, when entered into, and the Mortgage; and
- (h) copies of payment and performance bonds as required by the provisions of Section 4.7(d) above; and
- (i) the original Oriental Deed; and
- (j) such other documents as are reasonably required of Developer to effectuate the transaction.

Developer shall simultaneously deliver copies of documents (c)-(e) to the Inspector (as hereinafter defined), as well as one set of the Working Drawings and Specifications as prepared and available from time to time and the Budget. In addition, Developer shall deliver to the City copies of documents (a)-(g), the original payment and performance bonds affecting the Demolition Contractor, and any Contractor or Specialty Contractor as required by Section

4.7(d), and (to the extent not previously delivered) original certificates of insurance as are required by the City pursuant to subsection 4.14 below. Developer shall also provide to the City with an opinion of counsel, substantially in the form attached hereto as Exhibit I, with such changes as may be required by or acceptable to the Corporation Counsel of the City acting reasonably. In addition, Developer shall deliver to the City current searches under Developer's name and Livent as follows:

Secretary of State	UCC Search
Secretary of State	Federal Tax Search
Cook County Recorder	UCC Search
Cook County Recorder	Fixtures Search
Cook County Recorder	Federal Tax Search
Cook County Recorder	State Tax Search
Cook County Recorder	Memoranda of Judgments Search
U.S. District Court	Pending suits and judgments
Clerk of Circuit Court (Cook County)	Pending suits and judgments

and such other searches from such other offices as the City may require in its reasonable discretion.

Escrowee shall also have received from the City: (a) one copy of the Agreement; and (b) a certified copy of the ordinance authorizing the City to enter into this transaction.

3. **Disbursements.** Disbursements from the Escrow covering the Project costs described in paragraph 1 of this subsection 4.8(c) shall be made by the Escrowee, upon receipt of certification for payment by the Architect on AIA Form G702 (or variant) and the receipt of the prior approval of the Inspector, the Lender, and the City, in the following manner:

(a) **Method.** Subject to the provisions of the Agreement, the Escrowee shall disburse directly to Developer or to the Construction Manager, the Demolition Contractor, the pertinent Contractor or Specialty Contractor, as the case may be, or so if directed, to such Subcontractor, vendor and any other persons as have actually supplied labor, materials or services in connection with the Demolition Component Work, the renovation and/or rehabilitation of the facade of the Oliver Building, or the construction of the Project.

(b) **Holdback Provision.** The City and/or Developer shall be permitted to hold back for later deposit with Escrowee, or direct the Escrowee to hold back, on each request for advance for payment covering the costs described in paragraph (1) above of this subsection 4.8(c) an amount equal to ten percent (10%) of the requested sum until the Architect certifies the substantial completion of the Project on AIA Form G704 and the City issues its Certificate with regard to completion of the Project; except that the Developer's Equity shall be fully deposited with the City no later than April 10, 1996 and subsequently deposited with the Escrowee upon execution of the Escrow Agreement by the parties.

(c) **Final Disbursement.** Subject to the provisions of the Agreement, and as long as Developer is not in default in the due, prompt and complete performance or observance of any of its covenants or obligations contained in the Agreement, the Covenant of Performance and the Mortgage, the final disbursement of funds constituting the holdback portion referred to above shall be made

through the deposit of funds that have been retained if not previously deposited in the Escrow and disbursed by the Escrowee when Developer has completed the Project to the satisfaction of the Architect as evidenced by the issuance of a Final Certificate of Payment on AIA Form G702, and by the Inspector as evidenced by the issuance of the Inspector's Certificate regarding substantial Completion of the Project, and provided that Developer has submitted to the Escrowee, the DPD, the Lender and the Inspector affirmative proof that no materialmen's liens or claims or liens exist affecting the Site or could result due to the undertaking of the Project. Any sums thereafter remaining in the Escrow shall be disbursed pursuant to applicable provisions of the Agreement.

(d) **Request for Advances.** Concurrently with the request for any disbursement from the Escrow ("Request for Advance"), Developer shall furnish to the Escrowee, the DPD, the Lender and the Inspector, separately with respect to each disbursement request, a Request for Advance upon the form attached hereto as Exhibit J duly signed with all blanks appropriately filled in setting forth such details concerning the costs contained therein as said parties shall require, including: (a) a detailed breakdown of percentages and costs of the completion of various phases of the Demolition Component Work, the renovation and/or rehabilitation of the facade of the Oliver Building and the renovation and construction of the other Project improvements, showing the amounts expended to date for such demolition, renovation, rehabilitation or construction, as the case may be, and

the amounts then due and unpaid, an itemized estimate of the amount necessary to complete the work in its entirety and also containing certification by Developer and the certification for payment by the Architect on AIA Form G702 that the demolition, renovation, rehabilitation or the construction of the Project to date of such certificate complies with the pertinent Component; (b) if requested by the Escrowee, the Inspector, the City, or the Lender, a list of the names and addresses of all material dealers, laborers and Subcontractors with whom agreements have been made by Developer, the Construction Manager, any Component Contractor, Specialty Contractor, or Demolition Contractor, as the case may be; (c) if requested by the Escrowee, the Inspector, the City or the Lender, receipted invoices, and/or releases or waivers of lien on forms approved by the Escrowee and the Inspector from each material dealer, contractor and Subcontractor who has done work or has furnished materials for the Project, including but without limitation, those covered by each such Request for Advance. If work on the Site has begun prior to the initial disbursement, then Developer shall provide the Escrowee, the City and the Inspector with all such items as aforesaid, and/or acknowledgement of receipt of payment for work or materials previously provided, and any additional items as the Escrowee, the City and the Inspector may reasonably require prior to such initial disbursement.

Also included with a Request for Advance shall be Developer's written report describing any modifications, change orders or

amendments to any Component Contract or Specialty Contract, all as described further in subsection 4.7(c) above.

4. Compliance with Conditions Precedent. Each request for disbursement from the Escrow submitted by Developer shall be subject to compliance to the satisfaction of the Escrowee, the City, the Lender and the Inspector, in both form and substance, with the applicable conditions precedent for disbursements as set forth in the Agreement.

5. Time for Payment of Requisitions. Upon receipt of a Request for Advance by the Escrowee, the Escrowee shall have fifteen (15) business days in order to effect such Advance.

6. Inspection. During the undertaking of the Project, the Lender shall employ, for the benefit of the City, the Lender and Developer (or in the event no Lender exists, then the City shall employ) an inspector or architect ("Inspector") other than the architect who prepared the Schematics or the Working Drawings and Specifications. The fees and expenses to be paid the Inspector shall be provided by the City exclusive of the City's Financial Contribution. The Inspector shall be selected by the Lender and acceptable to the City and Developer, or if no Lender exists, by the City and acceptable to Developer. The Inspector shall review for the parties all activities associated with the completion of the Project, which Inspector shall certify or otherwise indicate to the Escrowee on the form attached hereto as Exhibit K that the completion of such work of the Project to the date of each Request for Advance and as certified by the Architect is as set forth in

said Request for Advance and certificate, and that such demolition, renovation, rehabilitation or construction, as the case may be, complies with the pertinent Component, such indication from the Inspector to be a condition precedent to the approval by the Escrowee of any submitted Request for Advance of Developer. A representative of the DPD shall have the right, but not the obligation, to accompany the Inspector during his inspection of the Project. In such event, the DPD representative shall be accompanied by a representative of Developer and shall not possess the authority to issue instructions to any personnel at the Site other than through the representative of Developer.

Prior to the final completion of the Project, Developer, the Architect, the Inspector and the City shall conduct a preliminary inspection of the Site, and thereafter the Inspector (in consultation with the Developer, the City and the Architect) shall prepare a list of punch list items to be undertaken by Developer. Once such work is completed, the Inspector and the City shall re-inspect the Site, and if satisfied, the Inspector shall issue a certificate ("Final Inspector's Certificate") that the construction of the Project is completed in accordance with the Components collectively constituting the Working Drawings and Specifications, the Agreement, the Redevelopment Documents and if applicable, the Landmarks Ordinance and the Preservation Easement. The determination of the Inspector with regard to Developer's compliance with the construction of the Project in accordance with the pertinent Component and the Working Drawings and Specifications

collectively as described in this Section shall be binding on the parties.

7. Disbursements; Deficiencies. The Escrowee shall pay any and all such disbursements directly to the Construction Manager, the pertinent Contractor, Specialty Contractor, or the Demolition Contractor, as the case may be, or such person or persons as have actually supplied labor, materials, property or services in connection with the undertaking of the pertinent Component Work or Specialty Work. In no event shall the Escrowee be required to disburse any Advance which, in the Lender's or the City's reasonable opinion, shall reduce the remaining amounts available to pay for the balance of the work, labor and materials necessary to fully complete the Project. In accordance with the provisions of subsection 4.7(c) above, if at any time it shall appear to the City (or the Lender, if any) that the undisbursed portion of funds available and the remaining contingency reserve is insufficient, then Developer, within ten (10) days of written notice from the City or the Escrowee, shall be required to deposit such necessary funds in Escrow or otherwise to identify to the City and the Lender other funds to be made available as contingency or otherwise to complete the Project, and until then, it is expressly understood and agreed that, absent an express waiver by the Lender and the City, no Advance shall be made by the Escrowee. In the event that at any time the Escrowee (at the written request of the Lender or the City) demands that Developer remedy any such deficiency and Developer shall fail to do so as aforesaid, then the

Escrowee shall have no further obligation to make further disbursement until said deficiency is remedied. In the event the Lender or the City shall require and Developer shall provide any sums to remedy deficiencies as aforesaid, the Escrowee shall hold said sums in a separate account established for such purpose, and such funds shall not be commingled with the proceeds of the Escrow or, at the sole option of the Escrowee, the Escrowee may apply all or any portion of such deposit to payment of the submitted Request for Advance. Developer's failure either to remedy any deficit or to identify other funds to be made available as contingency or otherwise complete the Project as aforesaid shall constitute a default of the terms of the Agreement.

8. **Investment of Escrow Funds.** The City's Financial Contribution, upon its deposit from time to time by the City in the Escrow, shall be invested or reinvested by the Escrowee at the written direction of the City to the extent permitted by law. Any interest received upon said investment of escrow funds shall be paid to the City.

4.9 **Relocation of Utilities.** In the event Developer requests the relocation, repair or replacement of any existing City utility lines in and under the Site, the public streets or private property adjacent to the Site, Developer agrees to cause such utilities to be relocated. The DPD shall use its best efforts to assist Developer in obtaining the cooperation of any City agency with regard to the relocation, repair or replacement of existing utility lines. Except to the extent any portion of the City's Financial

Contribution is to be used therefor pursuant to the Agreement, under no circumstances shall the City be financially responsible for the relocation, repair or replacement of any utility lines as a result of the Agreement.

4.10 Commencement and Completion of the Project. Developer shall commence with the construction of the Project within thirty (30) days from the issuance of the first building permit affecting the Project. Except as otherwise provided in the Agreement, Developer shall complete the Project (as evidenced by the issuance of the Inspector's Certificate regarding the substantial completion of the Project and the subsequent completion of any "punch list" items), subject to such Permitted Delays as are described in subsection 5.2 below, by the earlier of: (a) twenty-four (24) months from the earlier of (i) issuance of the first building permit, and (ii) the later of the date by which vacant possession of the Oliver Building is delivered to Developer and the Oriental Property is acquired by Developer; or (b) June 30, 1998. Developer agrees for itself, its successors and assigns, that Developer, its successors and assigns, shall promptly begin and diligently complete the Project within the time periods specified in this subsection 4.10.

4.11 Barricades. Prior to the commencement of any construction activity requiring barricades, Developer shall install a construction barricade of a type and appearance satisfactory to the City and constructed in compliance with all applicable federal, state or City laws, ordinances and regulations. The City shall

have the right to approve the maintenance, appearance, color scheme, painting, nature, type, content and design of all barricades.

4.12 Signs and Public Relations. Developer shall erect a sign of size and style approved by the DPD in a conspicuous location at the Site during the construction of the Project, indicating that financing for the Project has been provided by the City. The City reserves the right to include the name, photograph, artistic rendering of the Project and other pertinent information regarding Developer, the Project and the Site in the City's promotional literature and communications.

4.13 Certificate of Completion. As the construction of the Project is completed in accordance with the approved Working Drawings and Specifications, the Agreement, the Redevelopment Documents and, if applicable, the Landmarks Ordinance and the Preservation Easement (as evidenced by the issuance of the Final Inspector's Certificate, as described above), the City, upon written request by Developer, shall furnish Developer with an appropriate Certificate. The Certificate shall be a conclusive determination of satisfaction and termination of the covenants in the Agreement with respect to the obligations of Developer and its successors and assigns to complete the Project. The Certificate, however, shall not constitute evidence that Developer has complied with any applicable provisions of federal, state and local laws, ordinances and regulations with regard to the completion of the Project, nor shall it serve as any "guaranty" of the structural

soundness or quality of the construction of the Project, nor shall it serve to release Developer, or its successors and assigns, from its obligations as described in Section VII of the Agreement.

The Certificate shall be in recordable form. Upon written request by Developer for the Certificate, the City, within twenty (20) days after receipt of the same, shall undertake an inspection of the Site accompanied by a representative of Developer and thereafter provide Developer either with the Certificate or a written statement indicating in adequate detail how Developer has failed to complete the Project in conformity with the Redevelopment Documents, the Agreement and the Working Drawings and Specifications or is otherwise in default, and what measures or acts will be necessary, in the reasonable opinion of the City, for Developer to perform in order to obtain the Certificate. Developer shall promptly, but in all events within sixty (60) days, correct any such nonconformity or default. Upon compliance with the City's requirements, Developer shall resubmit a written request for a Certificate from the City.

4.14 Insurance.

Developer shall provide and maintain at Developer's own expense, during the Term of the Agreement, the insurance coverages and requirements specified below, insuring all operations related to the construction of the Project and the terms and provisions of the Agreement.

Insurance To Be Provided.

(a) Workers Compensation and Employers Liability Insurance. Workers Compensation and Employers Liability Insurance, as prescribed by applicable law covering all employees who are to provide a service under the Agreement and Employers Liability coverage with limits of not less than \$500,000 for each accident or illness.

(b) Commercial General Liability Insurance (Primary and Umbrella). Commercial General Liability Insurance or equivalent with limits of not less than \$2,000,000 per occurrence, combined single limit, for bodily injury, personal injury, and property damage liability. Coverages shall include the following: All premises and operations, products/completed operations (for a minimum of two (2) years following project completion), explosion, collapse, underground, independent contractors, separation of insureds, defense, and contractual liability (with no limitation endorsement). The City, its employees, elected officials, agents, and representatives are to be named as additional insureds on a primary, non-contributory basis for any liability arising directly or indirectly from the work.

(c) Automobile Liability Insurance (Primary and Umbrella). When any motor vehicles (owned, non-owned and hired) are used in connection with work to be performed, Developer shall provide Comprehensive Automobile Liability Insurance with limits of not less than \$2,000,000 per occurrence, combined single limit,

for bodily injury and property damage. The City is to be named as an additional insured on a primary, non-contributory basis.

(d) All Risk Builders Risk Insurance. During the undertaking of the Project and any subsequent repair work, Developer or its Construction Manager, the Demolition Contractor, any Component Contractor, or Specialty Contractor, shall provide or cause to be provided All Risk Builders Risk Insurance, at replacement cost, for materials, supplies, equipment, machinery and fixtures that are or will be part of the permanent facility. Coverages shall include but not be limited to the following: right to partial occupancy, material stored off-site and in-transit, boiler and machinery, earth movement, flood including surface water backup, sewer backup and seepage, collapse, water damage, debris removal, faulty workmanship or materials, testing, and mechanical-electrical breakdown. The City and Lender shall be named as loss payee.

(e) Contractors Pollution Liability Insurance. When any work related to the Project is undertaken which may cause an environmental exposure, Developer shall provide or cause to be provided Contractors Pollution Liability Insurance with limits of not less than \$1,000,000 insuring bodily injury, property damage, and environmental clean-up costs. The City is to be named as an additional insured on a primary, non-contributory basis.

(f) All Risk Property Insurance. Upon completion of the Project as evidenced by the issuance of the Inspector's certificate of substantial completion, Developer shall provide All

Risk Property Insurance in the amount of full replacement value of the Property including improvements and betterments to protect against loss or damage to or destruction of the facility. Coverage extensions shall include boiler and machinery, collapse, sewer back-up, sprinkler leakage and flood. The City and Lender shall be named as loss payees.

In the event of any damage or destruction to the Oriental Theater or other improvements of the Property caused by fire or other hazard, the insurance proceeds shall be utilized toward the renovation and rehabilitation of the Oriental Theater and the other Project improvements; provided, however, that prior to the issuance of the Certificate by the City, if Developer and the City conclude that the Project improvements are destroyed beyond repair and will not be rebuilt, Developer and the City shall share in the insurance proceeds on the basis of their respective financial contributions toward the completion of the Project (including the acquisition costs for the Site, except in the event that the City exercises its option to acquire the Site as provided for in this paragraph). In such event, at the sole option of the City (to be exercised, if at all, in connection with the disbursement of proceeds of insurance resulting from any such casualty), the City may elect to have the Site conveyed by Developer to the City for nominal consideration.

If the Project improvements are destroyed beyond repair subsequent to the issuance by the City of the Certificate but prior to the expiration of the Term of the Agreement, and if Developer, Lender (if any) and the City mutually conclude that the Project

improvements are destroyed beyond repair and will not be rebuilt, then the insurance proceeds shall be distributed in the following order: (1) the Lender shall be repaid any amounts due and owing under the First Mortgage (or its replacement); (2) Developer shall be entitled to a reimbursement of all of its reasonable Project costs as certified by Developer to the City, (3) the City shall be reimbursed for the amounts disbursed of the City's Financial Contribution, and (4) any remaining sums not utilized in (1) and (3) above shall be distributed to the City and Developer on a pro-rata basis determined by each parties' respective contribution expended on the Project and the redevelopment of the Site. Furthermore, at the sole option of the City (to be exercised, if at all, in connection with the disbursement of proceeds of insurance resulting from any such casualty), the City may elect to have the Site conveyed by Developer to the City for nominal consideration.

(g) Professional Liability Insurance. When any architects, engineers, the Construction Manager or other professional consultants perform work in connection with the Agreement, Professional Liability Insurance covering acts, errors, or omissions shall be maintained with limits of not less than \$1,000,000. Coverage shall include contractual liability. When policies are renewed or replaced, the policy retroactive date must coincide with, or precede, start of work on the Agreement. A claims-made policy which is not renewed or replaced must have an extended reporting period of two (2) years.

(h) Valuable Papers Insurance. When any plans, designs, drawings, specifications and documents are produced or used under the Agreement, Valuable Papers Insurance shall be maintained in an amount to insure against any loss whatsoever, and shall have limits sufficient to pay for the re-creation and reconstruction of such records.

Additional Requirements.

(aa) Developer will furnish the City, in care of the Department of Purchases, Contracts and Supplies, City Hall, Room 403, 121 North LaSalle Street, 60602, original Certificates of Insurance evidencing the required coverage to be in force on the date of this Agreement, and Renewal Certificates of Insurance, or such similar evidence, if the coverages have an expiration or renewal date occurring during the Term of the Agreement. The Developer shall submit evidence of insurance on the City of Chicago Insurance Certificate Form or equivalent at or prior to the earlier of the Oliver Property Closing Date or the Oriental Property Closing Date.

(bb) The receipt of any certificate does not constitute agreement by the City that the insurance requirements in the Agreement have been fully met or that the insurance policies indicated on the certificate are in compliance with all Agreement requirements. The failure of the City to obtain certificates or other insurance evidence from Developer shall not be deemed to be a waiver by the City. Developer shall advise all insurers of the Agreement provisions regarding insurance. Non-conforming insurance

shall not relieve Developer of the obligation to provide insurance as specified herein. Nonfulfillment of the insurance conditions may constitute a violation of the Agreement, and the City retains the right to stop work or suspend the Agreement until proper evidence of insurance is provided.

(cc) The insurance shall provide for sixty (60) days prior written notice to be given to the City in the event coverage is substantially changed, canceled, or non-renewed.

(dd) Any and all deductibles or self insured retentions on referenced insurance coverages shall be borne by Developer.

(ee) The Developer agrees that insurers shall waive their rights of subrogation against the City of Chicago, its employees, elected officials, agents, or representatives.

(ff) The Developer expressly understands and agrees that any coverages and limits furnished by Developer shall in no way limit the Developer's liabilities and responsibilities specified within the Agreement documents or by law.

(gg) The Developer expressly understands and agrees that any insurance or self insurance programs maintained by the City of Chicago shall apply in excess of and not contribute with insurance provided by the Developer under the Agreement.

(hh) The required insurance shall not be limited by any limitations expressed in the indemnification language herein or any limitation placed on the indemnity therein given as a matter of law.

(ii) The Developer shall require all subcontractors to provide the insurance required herein or Developer may provide the coverages for subcontractors. All subcontractors shall be subject to the same insurance requirements of Developer.

(jj) If Developer or subcontractor desires additional coverages, the Developer and each subcontractor shall be responsible for the acquisition and cost of such additional protection.

(kk) The City of Chicago Risk Management Department maintains the right to modify, delete, alter or change these requirements.

4.15 Prohibition Against Unpermitted Encumbrances.

Prior to the completion of the Project as certified by the City, neither Developer nor any successor in interest to the Site shall engage in any financing or other transaction the effect of which creates an encumbrance or lien upon the Site; provided, however, that Developer, subject to compliance with the Agreement and after receiving the prior written consent of the City, shall be permitted to obtain financing solely to obtain the First Mortgage as described in subsection 4.8(a) above to the extent necessary for completing the Project.

4.16 Mortgagees Not Obligated to Construct. Notwithstanding any of the provisions of the Agreement, the holder of any mortgage or its affiliate authorized by the Agreement (including any holder who obtains title to the Site or any part thereof as a result of foreclosure proceedings, or by deed transfer in lieu thereof) shall

not be obligated by the provisions of the Agreement to construct or complete the construction of the Project or to guarantee such construction or completion; provided, however, nothing in this subsection 4.16 or any section of the Agreement shall be deemed or construed to permit or authorize any such holder or its affiliate to devote the Site or any part thereof to any uses, or to construct any improvements thereon, other than those uses or improvements provided for or permitted in the Redevelopment Documents and the Agreement, including, without limitation, subsections 5.3(d) and (e) of the Agreement. In the event, however, that Developer has obtained Lender Financing, if the Lender, due to the occurrence of a breach by Developer of its obligations under the First Mortgage (or its replacement) or the Agreement, obtains possession or title to the Site by foreclosure or deed in lieu of foreclosure, the Lender may be entitled, upon receipt of written approval by the DPD, to utilize any unspent funds from the City's Financial Contribution to complete the Project as described in the Agreement, so long as Lender complies with the terms and conditions of the Agreement.

Whenever the City shall deliver a notice or demand with respect to any breach or default by Developer of its obligations under the Agreement, the City shall at the same time forward a copy of such notice or demand to any mortgagee whose address has been given in writing to the City. After any such default by Developer, each mortgagee shall (insofar as the City is concerned) have the right, at the mortgagee's option, to remedy such default.

Whenever the mortgagee shall deliver a notice or demand to Developer with respect to any breach or default by Developer of its obligations under the First Mortgage, the mortgagee shall at the same time forward a copy of such notice or demand to the City at the addresses listed in subsection 8.10 below. After any such default by Developer, the City and each mortgagee shall have the right to remedy such default to the extent such default is susceptible to being cured.

SECTION V

PERFORMANCE

5.1 Time of the Essence. Time is of the essence of the Agreement.

5.2 Permitted Delays. Neither the City, Developer, or any successor in interest to Developer, shall be considered in breach of its obligations with respect to property acquisition needed for, and the commencement and completion of, the Project in the event of delay in the performance of such obligations due to causes, whether foreseeable or unforeseeable, beyond such party's control and without such party's fault or negligence, including but not limited to, any delays in eminent domain proceedings regarding the Oliver Property due to recognized legislative and judicial constraints, any delays or halts in the construction of the Project which are compelled by court order, any delays caused by the City failing to respond to Developer within applicable time periods (as further described in the Agreement), acts of God, acts of the public enemy,

acts of the United States, acts of the other party, fires, floods, epidemics, quarantine restrictions, strikes, industry-wide lockouts, inability to obtain materials, work stoppages, embargoes and unusually severe weather or delays of contractors or subcontractors due to any such cause (collectively, "Permitted Delays"). The time for the performance of the obligations shall be extended only for the period of the Permitted Delays if, except in the case of any eminent domain proceedings that relate to the Oliver Property, the party seeking the extension shall request it in writing of the other party within twenty (20) days after the beginning of any such Permitted Delays.

5.3 Breach.

(a) **Generally.** Except as otherwise provided in the Agreement, in the event of default by any party or its successor in interest in the performance of its obligations under the Agreement, such party or successor, upon written notice from the other, shall proceed to immediately cure or remedy such default but, in any event, not later than sixty (60) days after receipt of such notice. In the event such action is not diligently pursued or the default not cured within a reasonable time, the aggrieved party may institute such proceedings at law or in equity as may be necessary or desirable in its sole discretion to cure and remedy such default, including but not limited to, proceedings to compel specific performance by the party in default of its obligations.

(b) **Event of Default.** For purposes of the Agreement, the occurrence of any one or more of the following, which remains

uncured during the cure period afforded by subsection 5.3(a) above unless a different cure period is specifically provided with respect to any item set forth in this subsection 5.3(b) below, shall constitute an "Event of Default":

- (1) If, during the Term of the Agreement, any covenant, warranty, representation or statement made or furnished by Developer under the Agreement (including the covenants, representations and warranties of Developer described in subsection 2.1 above) has been breached or is not true and correct in any material respect and remains uncured after the cure period afforded by subsection 5.3(a); or
- (2) If any petition is filed by or against Developer under the Federal Bankruptcy Code or any similar state or federal law, whether now or hereinafter existing (and in the case of involuntary proceedings, failure to cause the same to be vacated, stayed or set aside within sixty (60) days after filing); or
- (3) Failure of Developer to develop the construction documents in accordance with subsection 4.5 above; or
- (4) If, unless otherwise governed by the terms and conditions set forth in subsection 5.2 concerning Permitted Delays, Developer defaults in fulfilling its obligations with respect to the completion of the Project (including the nature of and the dates of the beginning and completion thereof) or abandons or substantially suspends renovation

or construction work, and such default, violation, abandonment or suspension shall not be cured, ended or remedied within thirty (30) days of the date Developer receives written demand by the City to cure such default;
or

(5) Failure of Developer, consistent with the terms of this Agreement, to devote and use the Oriental Theater as set forth in subsection 2.1(j) above and 7.2(c) below; or

(6) Failure of Developer to pay real estate taxes or assessments affecting the Site or any part thereof when due, or placing thereon any encumbrance or lien unauthorized by the Agreement, or suffering any levy or attachment to be made, or any materialmen's or mechanics' lien, or any other unauthorized encumbrance or lien to attach to the Site or any part thereof, and such taxes or assessments shall not have been paid, or the encumbrance or lien removed or discharged or provision satisfactory to the City made for such payment, removal or discharge within sixty (60) days after written demand by the City to remove such lien or encumbrance, or security is posted with the City or the Title Company sufficient to satisfy such liens and costs; or

(7) After delivery of notice, failure to comply with the real estate tax covenants described in subsection 7.7 below;
or

- (8) Default by Developer in the payment of any sums required to be paid by Developer pursuant to the Agreement or the First Mortgage Note, at the times specified therein or as a consequence of redemption or acceleration; or
- (9) The occurrence of an event of default within the context of the First Mortgage, Covenant of Performance or the Mortgage; or
- (10) Failure to comply with the public policy covenants and other provisions as described further in Section VI and VII below, and such default continues for a period of sixty (60) days after delivery of notice; or
- (11) Any assignment, pledge, encumbrance, transfer, hypothecation or other disposition is made in violation of subsection 8.2 below or elsewhere in the Agreement.
- (12) Failure to comply with Developer's Employment Opportunity Obligation provisions of Section VI and the various subsections thereof.

(c) **Prior to Conveyance of the Oliver Property.** If, from the execution date of the Agreement and before the City conveys to Developer the Deed to the Oliver Property or funds the acquisition of the Oriental Property in accordance with the applicable provisions of the Agreement, whichever occurs earlier, Developer defaults in any specific manner as described in paragraph (b) of this subsection 5.3, and fails to timely cure such default after the delivery of notice of default pursuant to subsection 5.3(a) or (b), as applicable, the City may, upon delivery of written notice

to Developer and Lender, if any, immediately terminate the Agreement and institute any action or proceeding at law or in equity against Developer.

(d) After Conveyance of the Oliver Property Until Issuance of Certificate. If, subsequent to the conveyance of the Oliver Property to Developer by the City or funding by the City of the acquisition of the Oriental Property in accordance with the applicable provisions of the Agreement, whichever occurs earlier, and until the City issues its Certificate, Developer defaults in any specific manner as described in paragraph (b) of this subsection 5.3, then the City, after written notice to Developer and opportunity to cure pursuant to subsection 5.3(a) or (b), whichever is applicable, may declare any amounts due and owing under the Covenant of Performance to be due and payable immediately upon any such declaration. In addition, the City shall have the right to re-enter and take possession of the Oliver Property, to terminate the estate conveyed by the Deed to said Oliver Property to Developer as well as Developer's right of title and all other rights and interests in and to the Oliver Property, conveyed by the Deed to Developer, and re-vest title in said Oliver Property with the City, and the City shall further have the right to direct the Escrowee to record the Oriental Deed and vest title in the Oriental Property with the City; provided, however, that the acquisition of the Site by the City as described in this paragraph shall always be limited by, and shall not defeat, render invalid, or limit in any way (other than that which has been limited by the terms of the

First Mortgage), the lien of the First Mortgage authorized by the Agreement for the protection of the holders of the First Mortgage.

Upon the acquisition by the City of title to the Site as described in this subsection 5.3(d), the City may elect to complete the Project by utilizing the City's Financial Contribution and such other funds as are necessary to complete the Project, including, without limitation, funds to be provided by Livent pursuant to the Completion Guaranty, and by, if necessary, the hiring of an alternative Construction Manager and/or Contractors to complete the Project. Upon Completion of the Project, the City shall employ its best efforts to convey the Site through the issuance of a request for proposals ("RFP") to a Subsequent Developer who is a qualified and financially responsible party or parties as determined by the City, and which shall assume the obligation of operating the Oriental Theater and the other Project improvements to the satisfaction of the City and in accordance with the uses specified for the Site in the Redevelopment Documents and the Agreement. The proceeds from the sale of the Site by the City to the Subsequent Developer shall be utilized and distributed to the holder of the First Mortgage, as is necessary to satisfy the same, and thereafter in accordance with the provisions described in subsection 5.3(f) below.

In the alternative, upon the acquisition by the City of title to the Site as described in this subsection 5.3(d), the City may elect to issue the RFP to choose a Subsequent Developer willing to acquire and thereafter redevelop the Site. The Subsequent

Developer shall be selected based on the following criteria (listed in terms of priority):

FIRST: the ability to complete the specific Project in accordance with the terms and conditions of the Redevelopment Documents and the Agreement and, upon the issuance of the Certificate by the City, to operate the Oriental Theater and the other Project improvements to the satisfaction of the City and in accordance with the uses specified for the Site in the Redevelopment Documents and the Agreement.

SECOND: the ability to redevelop the Site in accordance with the uses specified for the Site in the Redevelopment Documents and the Agreement, and upon the issuance of the Certificate by the City, to operate the Project improvements to the satisfaction of the City and in accordance with the uses specified for the Site in the Redevelopment Documents and the Agreement.

THIRD : the ability to redevelop the Site for purposes consistent with the uses described in the Guidelines and the objectives of the City.

The sale and conveyance of the Site to the Subsequent Developer shall be undertaken in accordance with all applicable federal, state and local laws, ordinances and regulations and consistent with the objectives of the Redevelopment Documents and the Agreement.

(e) After Issuance of Certificate. If, subsequent to the issuance of the Certificate until the expiration of the Term of the Agreement, Developer seeks to abandon the Site due to its inability or unwillingness to utilize the Site for uses consistent with the Redevelopment Documents and the Agreement for whatever reason, except bankruptcy, the fee title to the Site shall automatically be transferred to the City upon receipt by the City of written notice of the intention of Developer to discontinue use of the Site, accompanied by a properly executed deed of conveyance. The fee title to the Site shall also transfer to the City upon the receipt of written notice by Developer from the City (and after the expiration of any applicable cure period) that Developer has failed to utilize the Site for uses consistent with the Redevelopment Documents and the Agreement. In conjunction with such notice to Developer, the City may declare any amounts due and owing under the Covenant of Performance to be due and payable immediately upon any such declaration.

Any transfer of title of the Site to the City as described in this subparagraph 5.3(e) shall be subject to and shall be limited by the lien of the First Mortgage or the mortgage from a permanent lender ("Permanent Mortgage") (other than those rights which have been limited by the terms of the First Mortgage or the Permanent Mortgage) authorized by the Agreement for the protection of the holders of the First Mortgage or Permanent Mortgage; provided, however, that the City has the option (commencing with the date that the City acquires title to the Site for the duration of the

nine (9) month period described in the following paragraph) to cause to be extinguished the lien of the First Mortgage or Permanent Mortgage by paying any and all sums remaining to be paid thereunder.

For a period of nine (9) months commencing with the date that the City re-acquires title to the Site, the DPD may issue a RFP concerning the future disposition of the Site and the selection of a Subsequent Developer to own the Site and operate the improvements located thereon. The Subsequent Developer shall be a qualified and financially responsible party selected by the City based on the following criteria (listed in terms of priority):

FIRST: the ability to operate the Project as constructed by Developer consistent with the terms of the Agreement and the Redevelopment Documents, whenever possible, and in light of applicable law, including, without limitation, the Landmarks Ordinance and the City's Zoning Ordinance.

SECOND: the ability to redevelop the Site for purposes consistent with the uses described in the Guidelines and the objectives of the City.

During the nine (9) month period described above, the City shall consult with the holders of the First Mortgage or the Permanent Mortgage concerning the selection of the Subsequent Developer.

Once the Subsequent Developer has been selected by the City in accordance with the RFP and takes title to the Site from the City,

the proceeds from said sale and conveyance shall be utilized to pay any and all sums remaining to be paid under the First Mortgage or Permanent Mortgage thereunder, and thereafter distributed in accordance with the provisions described in subsection 5.3(f) below.

If the Subsequent Developer selected and approved by the City shall assume ownership of the Site based on the criteria established as "THIRD" in subsection 5.3(d) or as "SECOND" in this subsection 5.3(e) as described above, the City shall:

(1) prior to the conveyance of the Site by the City to the Subsequent Developer, execute a redevelopment agreement with said Subsequent Developer governing the future use of the Site, the terms of which to be negotiated between the parties, or (2) concurrent with the conveyance of the Site to said Subsequent Developer, execute a release in recordable form with regard to those covenants and restrictions contained in the Agreement governing the use of the Site.

If the City is unable for whatever reason to identify a Subsequent Developer or is unwilling to itself assume the terms of the First Mortgage or the Permanent Mortgage or pay any and all sums remaining to be paid thereunder to the holder of the First Mortgage or Permanent Mortgage (all as described in this subsection 5.3 (e)), the City shall convey the Site to the holder of the First Mortgage or Permanent Mortgage by deed in lieu of foreclosure, and shall execute a release in recordable form with regard to those

covenants and restrictions contained in the Agreement governing the use of the Site.

(f) Distribution of Sale Proceeds. Upon the selection of the Subsequent Developer pursuant to the provisions contained in subsection 5.3(d) or 5.3(e), and the conveyance of the fee title to the Site from the City to the Subsequent Developer, the proceeds from said conveyance shall be utilized first to reimburse the City for:

- (a) costs and expenses incurred by the City with regard to the reconveyance of the Site from Developer, and the management and subsequent conveyance of the Site to the Subsequent Developer;
- (b) all taxes, assessments, and water and sewer charges with respect to the Site;
- (c) any payments made or necessary to be made (including attorneys' fees) to discharge or prevent from attaching or being made any subsequent encumbrances or liens due to obligations, defaults or acts of Developer, its successors or transferees;
- (d) any expenditures made or obligations incurred with respect to construction and maintenance of any Project improvements constructed on the Site; and
- (e) any other amounts owed to the City by Developer, its successors or transferees.

Any remaining sums shall be distributed to Developer.

5.4 Waiver and Estoppel. Any delay by the City in instituting or prosecuting any actions or proceedings or otherwise asserting its rights shall not operate as a waiver of such rights or operate to deprive the City of or limit such rights in any way. No waiver made by the City with respect to any specific default by Developer shall be construed, considered or treated as a waiver of the rights of the City with respect to any other defaults of Developer.

5.5 Indemnity. Developer hereby agrees to indemnify, defend and hold the City harmless from and against any losses, costs, damages, liabilities, claims, suits, actions, causes of action and expenses (including, without limitation, attorneys' fees and court costs) suffered or incurred by the City arising from or in connection with and to the extent of: (i) the failure of Developer to perform its obligations under the Agreement; (ii) the failure of Developer or any contractor to pay contractors, subcontractors or materialmen in connection with construction of the Project; (iii) a material misrepresentation or omission in the Redevelopment Documents or the Agreement (or other document relating thereto) which is the result of information supplied or omitted by Developer or by agents, employees, contractors or persons acting under the control or at the request of Developer; (iv) any activity undertaken by Developer at the Site; and (v) any claim or cost relating to the soil and environmental condition of the Site.

5.6 Access to the Site. Subsequent to the acquisition of the Site by Developer until the expiration of the Term of the

Agreement, any duly authorized representative of the DPD shall, at all reasonable times and upon reasonable notice to Developer (except in the event of an emergency), have access to the Site for the purpose of confirming Developer's compliance with the Agreement, the Redevelopment Documents, or both. Subsequent to the date of the opening performance at the Oriental Theater, however, the City's access to the Site shall be generally limited (except in the event of an emergency) to the time period from 9:00 a.m. until 5:00 p.m. weekdays, except during any performance in the auditorium and for one hour prior to and after conclusion of any performance.

5.7 City's Right to Inspect Records. Developer agrees that the City shall have the right and authority to review and audit, from time to time, Developer's books and records relating to the Project, including, without limitation, Developer's loan statements, general contractor's sworn statements, general contracts, subcontracts, purchase orders, waivers of lien, paid receipts and invoices. All such books, records and other documents shall be available at the offices of Developer for inspection, copying, audit and examination at all reasonable times by any duly authorized representative of the DPD.

SECTION VI

DEVELOPER'S EMPLOYMENT OPPORTUNITY OBLIGATION

6.1 Employment Opportunity. Developer agrees for itself and its successors and assigns, and shall contractually obligate its or their various contractors, subcontractors or any Affiliate of

Developer operating on the Site (collectively, with Developer, the "Employers" and individually an "Employer") to agree, that during the Term of the Agreement with respect to Developer and during the period of any other party's provision of services in connection with the construction of the Project or occupation of the Site:

- A. No Employer shall discriminate against any employee or applicant for employment based upon race, religion, color, sex, national origin or ancestry, age, handicap or disability, sexual orientation, military discharge status, marital status, parental status or source of income as defined in the City of Chicago Human Rights Ordinance, Chapter 2-160, Section 2-160-010 et seq., Municipal Code of Chicago, except as otherwise provided by said ordinance and as amended from time to time (the "Human Rights Ordinance"). Each Employer shall take affirmative action to ensure that applicants are hired and employed without discrimination based upon race, religion, color, sex, national origin or ancestry, age, handicap or disability, sexual orientation, military discharge status, marital status, parental status or source of income and are treated in a non-discriminatory manner with regard to all job-related matters, including without limitation: employment, upgrading, demotion, or transfer; recruitment or recruitment advertising; layoff or termination; rates of pay or other forms of compensation; and selection for training, including apprenticeship. Each Employer agrees to post in conspicuous places, available to employees and applicants for employment, notices to be provided by the City setting forth the provisions of this nondiscrimination clause. In addition, the Employers, in all solicitations or advertisements for employees, shall state that all qualified applicants shall receive consideration for employment without discrimination based upon race, religion, color, sex, national origin or ancestry, age, handicap or disability, sexual orientation, military discharge status, marital status, parental status or source of income.
- B. Each Employer shall comply with all federal, state and local equal employment and affirmative action statutes, rules and regulations, including, but not limited to, the Human Rights Ordinance, and the Illinois Human Rights Act, 775 ILCS 5/1-101 et seq. (1993), and any subsequent amendments and regulations promulgated thereto.

- C. Developer, in order to demonstrate compliance with the terms of this subsection, shall cooperate with and promptly and accurately respond to inquiries by the City, which has the responsibility to observe and report compliance with equal employment opportunity regulations of federal, state and municipal agencies.
- D. Developer and each Employer shall include the foregoing provisions of subparagraphs A through C in every contract entered into in connection with the Project, and shall require inclusion of these provisions in every subcontract entered into by any subcontractors, and every agreement with any Affiliate operating on the Site, so that each such provision shall be binding upon each contractor, subcontractor or Affiliate, as the case may be.
- E. Failure to comply with the employment obligations described in this subsection 6.1 shall be a basis for the City to pursue remedies under the provisions of Section V hereof.

6.2 City Resident Employment Requirement. Developer agrees for itself and its successors and assigns, and shall contractually obligate the other Employers, as applicable, to agree, that during the construction of the Project they shall comply with the minimum percentage of total worker hours performed by actual residents of the City of Chicago as specified in Section 2-92-330 of the Municipal Code of Chicago (at least fifty percent of the total worker hours worked by persons on the site of the construction for the Project shall be performed by actual residents of the City of Chicago); provided, however, that in addition to complying with this percentage, Developer and the other Employers shall be required to make good faith efforts to utilize qualified residents of the City of Chicago in both unskilled and skilled labor positions.

Developer and the other Employers may request a reduction or waiver of this minimum percentage level of Chicagoans as provided for in Section 2-92-330 of the Municipal Code of Chicago in accordance with standards and procedures developed by the Purchasing Agent of the City of Chicago.

"Actual residents of the City of Chicago" shall mean persons domiciled within the City of Chicago. The domicile is an individual's one and only true, fixed and permanent home and principal establishment.

Developer and the other Employers shall provide for the maintenance of adequate employee residency records to ensure that actual Chicago residents are employed on the Project. Developer and the other Employers shall maintain copies of personal documents supportive of every Chicago employee's actual record of residence.

Weekly certified payroll reports (U.S. Department of Labor Form WH-347 or equivalent) shall be submitted to the Commissioner of the DPD in triplicate, which shall identify clearly the actual residence of every employee on each submitted certified payroll. The first time that an employee's name appears on a payroll, the date that the company hired the employee should be written in after the employee's name.

Developer and the other Employers shall provide full access to their employment records to the Purchasing Agent, the Commissioner of the DPD, the Superintendent of the Chicago Police Department, the Inspector General, or any duly authorized representative

thereof. Developer and the other Employers shall maintain all relevant personnel data and records for a period of at least three (3) years after final acceptance of the work constituting the Project as evidenced by the Certificate.

At the direction of the DPD, affidavits and other supporting documentation will be required of Developer and the other Employers to verify or clarify an employee's actual address when doubt or lack of clarity has arisen.

Good faith efforts on the part of Developer and the other Employers to provide utilization of actual Chicago residents (but not sufficient for the granting of a waiver request as provided for in the standards and procedures developed by the Purchasing Agent) shall not suffice to replace the actual, verified achievement of the requirements of this subsection concerning the worker hours performed by actual Chicago residents.

When work at the Project is completed, in the event that the City has determined that Developer and the other Employers failed to ensure the fulfillment of the requirement of this subsection concerning the worker hours performed by actual Chicago residents or failed to report in the manner as indicated above, the City will thereby be damaged in the failure to provide the benefit of demonstrable employment to Chicagoans to the degree stipulated in this subsection. Therefore, in such a case of non-compliance it is agreed that 1/20 of 1 percent (.05%), 0.0005, of the aggregate hard construction costs set forth in the Budget (as the same shall be evidenced by approved contract value for the actual contracts)

shall be surrendered by Developer and/or the other Employers to the City in payment for each percentage of shortfall toward the stipulated residency requirement. Failure to report the residency of employees entirely and correctly shall result in the surrender of the entire liquidated damages as if no Chicago residents were employed in either of the categories. The willful falsification of statements and the certification of payroll data may subject Developer and/or the other Employers or employee to prosecution. Any retainage to cover contract performance that may become due to Developer and the other Employers pursuant to Section 2-92-250 of the Municipal Code of Chicago may be withheld by the City pending the Purchasing Agent's determination whether Developer and the other Employers must surrender damages as provided in this paragraph.

Nothing herein provided shall be construed to be a limitation upon the "Notice of Requirements for Affirmative Action to Ensure Equal Employment Opportunity, Executive Order 11246" and "Standard Federal Equal Employment Opportunity, Executive Order 11246," or other affirmative action required for equal opportunity under the provisions of the Agreement.

Developer shall cause or require the provisions of this subsection 6.2 to be included in all construction contracts and subcontracts related to the Project.

6.3 Developer's MBE/WBE Commitment. Developer agrees for itself and its successors and assigns, and shall contractually

obligate the Employers to agree, that during the construction of the Project:

- A. Consistent with the findings which support the Minority-Owned and Women Owned Business Enterprise Procurement Program ("MBE/WBE Program"), Section 2-92-420 et seq., Municipal Code of Chicago, and in reliance upon the provisions of the MBE/WBE Program to the extent contained in, and as qualified by, the provisions of this subsection 6.3, during the course of construction of the Project, at least the following percentages of the aggregate construction hard costs (as set forth in the Budget), but specifically excluding acquisition costs to be paid by the City with respect to the Site and the areas of construction costs noted in the Budget as being the subject of special waiver, shall be expended for contract participation by minority-owned businesses ("MBEs") and by women-owned businesses ("WBEs"):
 - a. At least 25% by MBEs.
 - b. At least 5% by WBEs.

- B. For purposes of this subsection 6.3 only, Developer (and any party to whom a contract is let by Developer pursuant to this Agreement) shall be deemed a "Contractor" and this Agreement (and any contract let pursuant thereto) shall be deemed a "Contract" as such terms are defined in Section 2-92-420, Municipal Code of Chicago. In addition, the term "minority-owned business" or MBE shall mean a business enterprise identified in the Directory of Certified Minority Business Enterprises published by the City's Purchasing Department, or otherwise certified by the City's Purchasing Department as a minority-owned business enterprise; and the term "women-owned business" or WBE shall mean a business enterprise identified in the Directory of Certified Women Business Enterprises published by the City's Purchasing Department, or otherwise certified by the City's Purchasing Department as a women-owned business enterprise.

- C. Consistent with Section 2-92-440, Municipal Code of Chicago, Developer's MBE/WBE commitment may be achieved in part by Developer's status as an MBE or WBE (but only to the extent of any actual construction work performed by Developer), or by a joint venture with one or more MBEs or WBEs (but only to the extent of the lesser of (i) the MBE or WBE participation in such

joint venture or (ii) the amount of any actual construction work performed by the MBE or WBE), by Developer utilizing a MBE or a WBE as a contractor (but only to the extent of any actual construction work performed by such contractor), by subcontracting or causing a contractor to subcontract a portion of the work to one or more MBEs or WBEs, or by the purchase of materials used in the Project from one or more MBEs or WBEs, or by any combination of the foregoing. Those entities which constitute both a MBE and a WBE shall not be credited more than once with regard to Developer's MBE/WBE commitment as described in this subsection 6.3.

- D. Developer shall deliver quarterly reports to the DPD describing its efforts to achieve compliance with this MBE/WBE commitment. Such reports shall include inter alia the name and business address of each MBE and WBE solicited by Developer or a contractor to work on the Project, and the responses received from such solicitation, the name and business address of each MBE or WBE actually involved in the Project, a description of the work performed or products or services supplied, the date and amount of such work, product or service, and such other information as may assist the DPD in determining Developer's compliance with this MBE/WBE commitment. The DPD shall have access to Developer's books and records, including, without limitation, payroll records and tax returns, and records and books of account in accordance with subsection 5.7 of the Agreement on five (5) business days' notice, to allow the City to review Developer's compliance with its commitment to MBE/WBE participation.
- E. The City shall have the right to terminate the Agreement upon the disqualification of a contractor as a MBE or WBE, if the contractor's status as a MBE or WBE was a factor in the approval of Developer for this Project, and such status was misrepresented by the contractor or Developer. In addition, the City shall have the right to terminate this Agreement upon the disqualification of any MBE or WBE subcontractor or supplier of goods or services if the subcontractor's status as a MBE or WBE was a factor in the approval of Developer to participate in this Project, and such status was misrepresented by the contractor or Developer. In the event that Developer is determined not to have been involved in any misrepresentation of the status of the disqualified contractor, subcontractor or supplier, the City, at its option, may choose to not terminate the Agreement; provided, however, Developer shall be obligated to discharge or

cause to be discharged the disqualified contractor or subcontractor or to terminate any contract or business with the disqualified supplier, and, if possible, identify and engage a qualified MBE or WBE as a replacement. For purposes of this Paragraph E, the disqualification procedures are further described in Section 2-92-540, Municipal Code of Chicago.

- F. Any reduction or waiver of Developer's MBE/WBE commitment as described in this subsection 6.3 shall be undertaken in accordance with Section 2-92-450, Municipal Code of Chicago.

6.4 Pre-Construction Meeting; Monitoring Requirements.

Prior to the commencement of construction of the Project and Component Work or Specialty Work pursuant to any Component, Developer shall be required to meet with the monitoring staff of the DPD with regard to Developer's compliance with its employment obligations described in this Section VI. Developer's Construction Manager, and Contractors and major Subcontractors shall be required to attend such pre-construction meetings. During said meeting, Developer shall demonstrate to the DPD its plan to achieve its employment obligations, the sufficiency of which must be approved by the DPD. During the construction of the Project, Developer shall submit documentation (as required in subsections 6.1-6.3 above) to the monitoring staff of the DPD. Failure to submit such documentation on a timely basis or, a determination by the DPD upon analysis of the documentation that Developer is not complying with its employment obligations described in this Section VI, shall, upon the delivery of written notice to Developer and lapse of the applicable grace period, be deemed an event of default. In such event, in addition to any remedies described in

this subsection 6.4, the City may , as allowed in Sec. 5.3(a), until such default is cured: (1) issue a written demand to Developer to halt construction of the Project; (2) withhold certain pertinent sums from payment to Developer or the Construction Manager, Contractors and Subcontractors; or (3) seek any other remedies against Developer available at law or in equity.

SECTION VII

PUBLIC POLICY COVENANTS AND POST-CERTIFICATE REQUIREMENTS

7.1 Developer's Public Policy Covenants. Developer shall not discriminate based upon race, color, religion, sex, national origin or ancestry, age, handicap or disability, sexual orientation, military status, parental status or source of income in the use or occupancy of the Project or any improvements located or to be erected on the Site or any part thereof. In addition, Developer agrees that it shall comply with any and all federal, state and local laws, rules and regulations with regard to accessibility standards for the physically disabled, including, without limitation, the Fair Housing Act, 42 U.S.C. 3601 et seq. (1990), the Americans with Disabilities Act of 1990, 42 U.S.C. 12101 et seq. (1990) and 47 U.S.C. 152, 221, 225 and 611 (1990), the Illinois Environmental Barriers Act, 410 ILCS 25/1 et seq. (1992), and the Illinois Accessibility Code, 71 Ill.Admin.Code ch. 1, subch. B, sec. 400.100 et seq. (1988). The undertakings of the

Developer in this subsection 7.1 are sometimes referred to herein as "Public Policy Covenants."

7.2 Use and Performance Requirements. From the period commencing with the issuance of the Certificate by the DPD and for the entire Term of the Agreement, Developer shall be obligated to comply with the following requirements and obligations with regard to the operation of the Oriental Theater and its ownership of the Site (collectively, the "Use and Performance Covenants"):

- (a) Maintenance of the Facade of the Oliver Building. Developer shall maintain the facade of the Oliver Building in accordance with the terms and conditions of the Landmarks Ordinance, the Preservation Easement and the Agreement.
- (b) Use of "Oriental". During the Term of the Agreement, Developer covenants to the City that it shall use on a continuous basis the name "Oriental" in any business, advertisement, promotional event or any other reference whatsoever with respect to the performances at the auditorium in the Project; provided, however, Developer, with the prior written approval of the DPD, may obtain a corporate or other sponsor(s) of the Project, whose name(s) or trademark(s) may appear in conjunction with the name of the Project.
- (c) First Performance. Developer shall stage the first live theatrical performance at the Oriental Theater within ninety (90) days of the issuance of the Inspector's Certificate of substantial completion.
- (d) Continuous Operation. Developer covenants to the City that it shall utilize the Oriental Theater for the presentation of live theatrical, cultural and entertainment events on a continual basis. In such regard, Developer covenants to the City that in no event shall the Oriental Theater be "dark" and not utilized more than an average of twelve (12) weeks per year in any "rolling" three (3) year period; provided, further, that in no event shall the Oriental Theater be "dark" and not utilized for a period in excess of eighteen (18) weeks during any single twelve (12) month period.

- (e) Percentage of Proceeds. Developer agrees to pay to the City an amount equal to seven percent (7%) of all gross proceeds from ticket sales for performances at the Oriental Theater, by way of a ticket surcharge, less any amusement tax or other tax in lieu thereof (if any), paid to the City by Developer from such ticket sales, which shall be payable on the same monthly schedule as amusement taxes are currently payable. These sums shall be calculated in accordance with the manner in which such taxes are collected (as of the execution date of the Agreement) pursuant to the City's Amusement Tax Ordinance, Sect. 4-156-020, Municipal Code of Chicago.
- (f) Lease of the Chicago Theater. During the five (5) year period commencing with the execution date of the Agreement, if requested by the City to do so, Developer shall utilize its best efforts to negotiate in good faith with the owner thereof for a lease of the Chicago Theater (which is located at 175 North State Street, Chicago) on terms satisfactory to both Developer and the City.

7.3 Employment Creation and Retention; Covenant to Remain in the City. Upon the issuance of the Certificate by the DPD and the commencement of the operation of the Oriental Theater by Developer, until the expiration of the Term of the Agreement, Developer shall be obligated to create and maintain at approximately ten (10) full-time permanent jobs and thirty six (36) part time jobs, either directly related to the operation of the Oriental Theater or generally at the Site.

7.4 Public Benefits Program. Developer has entered into that certain Public Benefits Agreement with the City dated as of _____, 1996, substantially in the form attached hereto as Exhibit L, to cause the development and implementation of a public benefits program ("Public Benefits Program") affecting the operation of the Oriental Theater.

7.5 Agreement to Provide Assistance to the Chicago School Reform Board of Trustees. Developer has entered into that certain Agreement to Provide Assistance to the Chicago School Reform Board of Trustees with the City dated _____, 1996, substantially in the form attached hereto as Exhibit M, whereby Developer shall inter alia make its theatrical resources available to the Chicago School Reform Board of Trustees. Said efforts must be contributed by Developer from the execution date of the Agreement until the expiration of the Term of the Agreement.

7.6 Status Reports. Developer shall provide the DPD with quarterly status reports (due on the first business day of each calendar quarter commencing with July 1, 1996) describing in sufficient detail Developer's compliance with Developer's Public Policy Covenants, and the Use and Performance Covenants. Also, only on a semi-annual basis, Developer shall provide the City with a status report describing in sufficient detail Developer's compliance with the Public Benefits Program and the Agreement to Provide Assistance to the Chicago School Reform Board of Trustees.

7.7 Real Estate Taxes and Other Governmental Charges.

(a) Governmental Charges.

(i) Payment of Governmental Charges. Developer agrees to pay or cause to be paid when due all Governmental Charges (as defined below) which are assessed or imposed upon Developer, the Site or the Project, or become due and payable, and which create, may create, or appear to create a lien upon the Developer or all or any portion of the Site or the Project. "Governmental Charge"

shall mean all federal, State, county, City, or other governmental (or any instrumentality, division, agency, body, or department thereof) taxes, levies, assessments, charges, liens, claims or encumbrances relating to Developer, the Site or the Project, including but not limited to, real estate taxes.

(ii) Right to Contest. Developer shall have the right before any delinquency occurs to contest or object in good faith to the amount or validity of any Governmental Charge by appropriate legal proceedings properly and diligently instituted and prosecuted in such manner as shall stay the collection of the contested Governmental Charge and prevent the imposition of a lien or the sale or forfeiture of the Site. Developer's right to challenge real estate taxes applicable to the Site is limited as provided for below; provided, however, that such real estate taxes must be paid in full when due and may be disputed only after such payment is made. No such contest or objection shall be deemed or construed in any way as relieving, modifying or extending Developer's covenants to pay any such Governmental Charge at the time and in the manner provided in the Agreement unless Developer has given prior written notice to the DPD of Developer's intent to contest or object to a Governmental Charge and, unless, at the DPD's sole option: (i) Developer shall demonstrate to the DPD's satisfaction that legal proceedings instituted by Developer contesting or objecting to a Governmental Charge shall conclusively operate to prevent or remove a lien against, or the sale or forfeiture of, all or any part of the Site to satisfy such Governmental Charge prior to final

determination of such proceedings; and/or (ii) Developer shall furnish a good and sufficient bond or other security satisfactory to the DPD in such form and amounts as the DPD shall require, or a good and sufficient undertaking as may be required or permitted by law to accomplish a stay of any such sale or forfeiture of the Site during the pendency of such contest, adequate to pay fully any such contested Governmental Charge and all interest and penalties upon the adverse determination of such contest.

(b) Developer's Failure To Pay or Discharge Lien. If Developer fails to pay any Governmental Charge which may create a lien against the Site or any part thereof or to obtain discharge of the same, Developer shall advise the DPD thereof in writing, at which time the DPD may, but shall not be obligated to, and without waiving or releasing any obligation or liability of Developer under the Agreement, in the DPD's sole discretion, make such payment, or any part thereof, or obtain such discharge and take any other action with respect thereto which the DPD deems advisable. All sums so paid by the DPD, if any, and any expenses, if any, including reasonable attorneys' fees, court costs, expenses and other charges relating thereto, shall be promptly disbursed to the DPD by Developer. Notwithstanding anything contained herein to the contrary, this paragraph shall not be construed to obligate the City to pay any such Governmental Charge. Additionally, if Developer fails to pay any such Governmental Charge, the City, in its reasonable discretion, may require Developer to submit to the

City audited financial statements or other evidence of its financial condition at the Developer's own expense.

(c) Real Estate Taxes.

(i) Acknowledgement of Real Estate Taxes. Developer agrees that (A) for the purpose of the Agreement, the total projected minimum assessed value of the Site ("Minimum Assessed Value") is shown on Exhibit N attached hereto and incorporated herein by reference for the years noted on Exhibit N; (B) Exhibit N sets forth the specific improvements which will generate the fair market values, assessments, equalized assessed values and taxes shown thereon; and (C) the real estate taxes anticipated to be generated and derived from the respective portions of the Site and the Project for the years shown are fairly and accurately indicated in Exhibit O.

(ii) Real Estate Tax Exemption. With respect to the Site or the Project, neither the Developer nor any agent, representative, lessee, tenant, assignee, transferee or successor in interest to the Developer shall, during the Term of the Agreement, seek, or authorize any exemption (as such term is used and defined in the Illinois Constitution, Article IX, Section 6 (1970)) for any year that the TIF Plan is in effect.

(iii) No Reduction in Real Estate Taxes. Neither Developer nor any agent, representative, lessee, tenant, assignee, transferee or successor in interest to Developer shall, during the Term of the Agreement, directly or indirectly, initiate, seek or apply for proceedings in order to lower the assessed value of all

or any portion of the Site or the Project below the amount of the Minimum Assessed Value as shown in Exhibit N for the applicable year.

(iv) No Objections. Neither Developer nor any agent, representative, lessee, tenant, assignee, transferee or successor in interest to Developer, shall object to or in any way seek to interfere with, on procedural or any other grounds, the filing of any Underassessment Complaint or subsequent proceedings related thereto with the Cook County Assessor or with the Cook County Board of Appeals, by either the City or any taxpayer. The term "Underassessment Complaint" as used in the Agreement shall mean any complaint seeking to increase the assessed value of the Site up to (but not above) the Minimum Assessed Value as shown in Exhibit N.

If Developer, despite the language of this subsection 7.7, has filed for and received a lower tax assessment than permitted in this subsection, Developer, after notice, shall agree to promptly file such notice to have the tax assessment re-assessed to the level permitted in this section.

7.8 Covenants Running with the Land. The parties agree that the restrictions contained in this Section VII are covenants running with the land and shall be binding upon Developer and its agents, representatives, lessees, successors, assigns and transferees from and after the date hereof; provided, however, that the covenants shall be released when the TIF Plan and Redevelopment Area for the purposes of the TIF Plan are no longer in effect. Developer agrees that any sale, lease, conveyance, or transfer of

title to all or any portion of the Site from and after the date hereof shall be made explicitly subject to such covenants and restrictions. Notwithstanding anything contained in subsection 7.7 and this subsection 7.8 to the contrary, the City in its sole discretion and by its sole action, without the joinder or concurrence of Developer, its successors or assigns, may waive and terminate the covenants and agreements set forth in said subsections.

SECTION VIII

MISCELLANEOUS PROVISIONS

8.1 Entire Agreement. Except as otherwise provided herein, the Agreement contains the entire agreement of the parties with respect to the Project and supersedes all prior agreements, negotiations and discussions with respect thereto, and shall not be modified, amended or changed in any manner whatsoever except by mutual consent of the parties as reflected by written instrument executed by the parties hereto. Notwithstanding the foregoing, it is agreed that no material amendment or change shall be made or be effective unless ratified or authorized by an ordinance duly adopted by the City Council of the City (and approved by the Lender, if any). The term "material" for the purpose of this subsection 8.1 shall be defined as any deviation from the terms of the Agreement which operates to cancel or otherwise reduce any developmental, construction or job-creating obligation of Developer by more than five percent (5%) or materially changes the Site or

character of the Project or any activities undertaken by Developer affecting the Site, the Project, or both, or increases any time agreed for performance by either party by more than ninety (90) days.

8.2 Assignability and Transfer. Unless permitted by the provisions contained in subsections 4.8(a), 5.3(c), 5.3(d) and 5.3(e) above, Developer, until the City issues the Certificate with regard to the completion of the Project, shall not assign, transfer or convey any right, title or interest in the Project, the Site, or both, or any of its duties or obligations under the Agreement as they relate to the Project, the Site, or both.

8.3 Conflict of Interest - City's Representatives Not Individually Liable. No member of the Commission, the DPD, or other City board, commission or agency, official, or employee of the City shall have any personal interest, direct or indirect, in Developer, the Agreement, the Site or the Project; nor shall any such member, official or employee participate in any decision relating to the Agreement which affects his or her personal interest or the interests of any corporation, partnership or association in which he or she is directly or indirectly interested. No member, official or employee of the City shall be personally liable to Developer, or any successor in interest, to perform any commitment or obligation of the City under the Agreement nor shall any such person be personally liable in the event of any default or breach by the City.

8.4 City Fee. The City may allocate the sum of Two Hundred Seventeen Thousand Five Hundred Dollars (\$217,500.00) for payment of costs incurred by the City for the administration and monitoring of the Project. Such fee shall be in addition to and shall not be deducted from or considered a part of the City's Financial Contribution, nor shall Developer be required to pay such fee.

8.5 Survival. All representations and warranties contained in the Agreement are made as of the execution date of the Agreement and the execution, delivery and acceptance hereof by the parties shall not constitute a waiver of rights arising by reasons of any misrepresentation.

8.6 Mutual Assistance. The parties agree to perform their respective obligations, including the execution and delivery of any documents, instruments, petitions and certifications, as may be necessary or appropriate, consistent with the terms and provisions of the Agreement.

8.7 Cumulative Remedies. The remedies of any party hereunder are cumulative and the exercise of any one or more of the remedies provided by the Agreement shall not be construed as a waiver of any of the other remedies of such party unless specifically so provided herein.

8.8 No Merger with Deed. The provisions of the Agreement shall not be merged with the Deed from the City to Developer affecting the Oliver Property.

8.9 Disclaimer. No provision of the Agreement, nor any act of the City, shall be deemed or construed by any of the parties, or

by third persons, to create any relationship of third-party beneficiary, or of principal or agent, or of limited or general partnership, or of joint venture, or of any association or relationship involving the City.

8.10 Notices. Any notice called for herein shall be in writing and shall be mailed postage prepaid by registered or certified mail with return receipt requested, or hand delivered and receipted, as follows:

If to the City: Commissioner
 Department of Planning
 and Development
 Room 1000, City Hall
 Chicago, Illinois 60602
 FAX: 312/744-0113

with a copy to: Corporation Counsel
 City of Chicago
 Room 511, City Hall
 Chicago, Illinois 60602
 Attn: Real Estate & Land
 Use Division
 FAX: 312/744-5185

If to Developer: Livent Realty (Chicago) Inc.
 Suite 600
 165 Avenue Road
 Toronto, Ontario
 Canada M5R 3S4
 Attn: President
 FAX: 416/324-5535

with a copy to: Smith Lyons
 Suite 5800 - Scotia Plaza
 40 King Street West
 Toronto, Ontario
 Canada M5H 3Z7
 Attn: R.W.J. Seyffert
 FAX: 416/369-7250

Notices are deemed to have been received by the parties three (3) days after mailing. Concurrent with such mailing, a copy of the notice shall be faxed to the above numbers. The parties, by notice given hereunder, may designate any further or different addresses to which subsequent notices, certificates or other communications shall be sent.

8.11 Headings. The headings of the various sections and subsections of the Agreement have been inserted for convenient reference only and shall not in any manner be construed as modifying, amending or affecting in any way the express terms and provisions hereof.

8.12 Governing Law. The Agreement shall be governed by and construed in accordance with the laws of the State of Illinois.

8.13 Recordation of the Agreement. Upon execution of the Agreement by the parties, Developer, at its sole expense, shall promptly record one original of the Agreement with the Office of the Recorder of Deeds of Cook County, Illinois.

8.14 Release. Upon the expiration of the Term of the Agreement, within thirty (30) days of receipt of written request, the City shall execute and deliver to Developer a release of the Agreement in recordable form.

8.15 No Third Party Beneficiary. The approvals given by the City pursuant to the Agreement and the Certificate when issued by the City shall be only for the benefit of Developer, the mortgagee or other lien holder, and their successors in interest in the Site

and no other person or party may assert against the City or claim the benefit of such approval or certificate.

8.16 Approval. Wherever the Agreement provides for the approval or consent of the City, the DPD or the Commissioner, or any matter is to be to the City's, the DPD's or the Commissioner's satisfaction, unless specifically stated to the contrary, such approval, consent or satisfaction shall be made, given or determined by the City, the DPD or the Commissioner in writing and in the reasonable discretion thereof. The Commissioner or other person designated by the Mayor shall act for the City or the DPD in making all approvals, consents and determinations of satisfaction, granting the Certificate or otherwise administering the Agreement for the City.

8.17 Successors and Assigns. The terms of the Agreement shall be binding upon the City, Developer, and their respective heirs, legal representatives, successors and assigns.

8.18 Severability. If any provision of the Agreement, or any paragraph, sentence, clause, phrase, or word, or the application thereof, in any circumstance, is held invalid, the remainder of the Agreement shall be construed as if such invalid part were never included herein and the Agreement shall be and remain valid and enforceable to the fullest extent permitted by law.

8.19 Counterparts. The Agreement may be executed in several counterparts, each of which shall be deemed an original and all of which shall constitute one and the same agreement.

IN WITNESS WHEREOF, the parties hereto have executed or caused the Agreement to be executed, all as of the date first written above.

CITY OF CHICAGO,
a municipal corporation

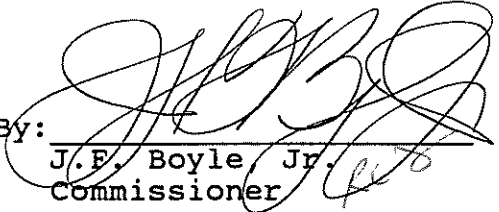
By: 

J.F. Boyle Jr.
Commissioner

LIVENT REALTY (CHICAGO) INC.
a Delaware corporation

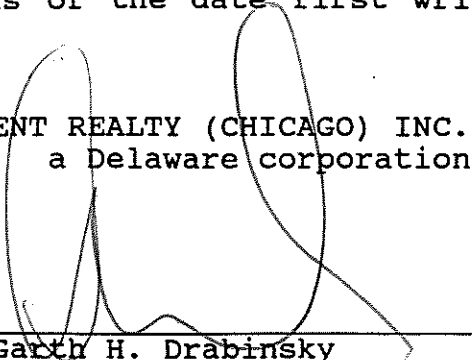
By: 

Garth H. Drabinsky
Chairman



Myron I. Gottlieb
President

STATE OF ILLINOIS)
) SS
COUNTY OF COOK)

I, Antonette J. Bielech, a Notary Public in and for said County, in the State aforesaid, do hereby certify that J. F. Boyle, Jr., personally known to me to be the Commissioner of Planning and Development of the City of Chicago, a municipal corporation, and personally known to me to be the same person whose name is subscribed to the foregoing instrument, appeared before me this day in person and being first duly sworn by me acknowledged that as such Commissioner of Planning and Development, he signed and delivered the said instrument, pursuant to authority given by the City of Chicago, as his free and voluntary act and as the free and voluntary act and deed of said corporation, for the uses and purposes therein set forth.

GIVEN under my hand and notarial seal this 29th day of April, 1996.

Antonette J. Bielech
Notary Public

(SEAL)

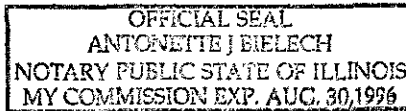

My Commission expires _____.

PROVINCE OF ONTARIO)
) SS
MUNICIPALITY OF TORONTO)

I, Rodney W.J. Seyffert, a Notary Public in and for said Province, do hereby certify that Garth H. Drabinsky, personally known to me to be the Chairman of Livent Chicago (Realty) Inc., a Delaware corporation, personally known to me to be the same person whose name is subscribed to the foregoing instrument, appeared before me this day in person and being first duly sworn by me acknowledged that as such Chairman, he signed and delivered the said instrument, pursuant to authority given by Livent Realty (Chicago) Inc., as his free and voluntary act and as the free and voluntary act of said corporation, for the uses and purposes therein set forth.

GIVEN under my hand and notarial seal this 29th day of April, 1996.

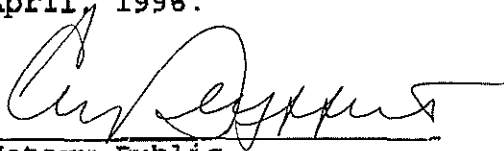

Notary Public

(SEAL)

My Commission expires No EXPIRY DATE .

PROVINCE OF ONTARIO)
) SS
MUNICIPALITY OF TORONTO)

I, Rodney W.J. Seyffert, a Notary Public in and for said Province, do hereby certify that Myron I. Gottlieb, personally known to me to be the President of Livent Chicago (Realty) Inc., a Delaware corporation, personally known to me to be the same person whose name is subscribed to the foregoing instrument, appeared before me this day in person and being first duly sworn by me acknowledged that as such President, he signed and delivered the said instrument, pursuant to authority given by Livent Realty (Chicago) Inc., as his free and voluntary act and as the free and voluntary act of said corporation, for the uses and purposes therein set forth.

GIVEN under my hand and notarial seal this 29th day of April, 1996.

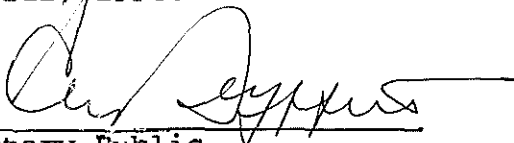

Notary Public

(SEAL)

My Commission expires No Expiry Date.

LIST OF EXHIBITS

- A Legal Description of the Oliver Property and the Oriental Property
- B Form of Deed
- C Permitted Exceptions
- D Schematics
- E Preliminary Budget
- F Redevelopment Project Costs
- G Mortgage
- H Covenant of Performance
- I Opinion of Counsel
- J Request for Advance
- K Inspector's Certificate
- L Public Benefits Agreement
- M Agreement to Provide Assistance to Chicago School Reform Board of Trustees
- N Minimum Assessed Value
- O Projected Real Estate Taxes
- P Landmark Requirements for Oliver Building
- Q Completion Guaranty
- R Schedule
- S List of Component Work and Specialty Work

EXHIBIT A

(Legal Description)

EXHIBIT A

Legal Description

THAT PART OF LOT 5 IN BLOCK 36 IN ORIGINAL TOWN OF CHICAGO IN SECTION 9, TOWNSHIP 39 NORTH, RANGE 14, EAST OF THE THIRD PRINCIPAL MERIDIAN, DESCRIBED AS FOLLOWS:

BEGINNING AT A POINT ON THE WEST LINE OF SAID LOT 5, ON DEARBORN STREET, 110 FEET SOUTH OF THE NORTHWEST CORNER THEREOF; THENCE EAST PARALLEL TO THE NORTH LINE OF SAID LOT, 37 FEET, 8 - 7/8THS INCHES; THENCE NORTH 110 FEET, MORE OR LESS, TO A POINT ON THE NORTH LINE OF SAID LOT 5, 38 FEET AND 11 INCHES EAST OF THE NORTHWEST CORNER THEREOF; THENCE WEST ALONG THE NORTH LINE OF SAID LOT 5, 38 FEET, 11 INCHES, TO THE NORTHWEST CORNER; THENCE SOUTH ALONG THE WEST LINE OF SAID LOT, ON DEARBORN STREET FRONT THEREOF; TO PLACE OF BEGINNING; IN COOK COUNTY, ILLINOIS.

Commonly known as: 157 North Dearborn Street,
Chicago, Illinois

PIN: 17-09-439-001-0000

EXHIBIT A

Oriental Parcel

PARCEL 1 (THEATER PARCEL)

THAT PART OF THE LAND, PROPERTY AND SPACE IN THE WEST ONE HALF OF LOT 7 IN BLOCK 36 IN ORIGINAL TOWN OF CHICAGO TOGETHER WITH ALL OF LOTS 5 AND 6 (SAID LOTS 5 AND 6 IN BLOCK 36 BEING ALSO KNOWN AS LOTS 2 THRU 12 IN ASSESSOR'S DIVISION OF LOTS 5, 6 AND 8 IN BLOCK 36 IN ORIGINAL TOWN OF CHICAGO) IN SAID BLOCK 36 IN ORIGINAL TOWN OF CHICAGO IN SECTION 9, TOWNSHIP 39 NORTH, RANGE 14 EAST OF THE THIRD PRINCIPAL MERIDIAN, EXCEPT THAT PORTION OF THE WEST 60.24 FEET OF SAID LOT 5 LYING SOUTH OF A LINE 110 FEET SOUTH OF THE NORTH LINE OF SAID LOT 5 AND EXCEPT ALSO THAT PORTION WESTERLY OF A LINE COMMENCING AT A POINT ON THE NORTH LINE OF SAID LOT 5, 38 FEET 11 INCHES EAST OF THE NORTHWEST CORNER OF SAID LOT 5 AND RUNNING SOUTH THROUGH A POINT, WHICH AT A DISTANCE OF 110 FEET 4 INCHES (MEASURED ALONG THE WEST LINE OF SAID LOT 5) SOUTH OF THE NORTH LINE OF SAID LOT 5 IS 37 FEET 7-7/8 INCHES EAST OF THE WEST LINE OF SAID LOT 5, BOUNDED AND DESCRIBED AS FOLLOWS:

ALL THAT PART OF THE AFORESAID LAND, PROPERTY AND SPACE LYING BELOW A HORIZONTAL PLANE HAVING AN ELEVATION OF +1.96' ABOVE CHICAGO CITY DATUM AND NORTHERLY OF THE VERTICAL PROJECTION OF THE FOLLOWING DESCRIBED LINE, COMMENCING AT THE POINT OF INTERSECTION OF THE NORTH LINE OF WEST RANDOLPH STREET WITH THE EAST LINE OF THE WEST HALF OF LOT 7 IN BLOCK 36 IN ORIGINAL TOWN OF CHICAGO;

THENCE NORTH ALONG SAID EAST LINE OF THE WEST HALF OF LOT 7 IN BLOCK 36 IN ORIGINAL TOWN OF CHICAGO, A DISTANCE OF 54.44 FEET TO THE POINT OF BEGINNING FOR THE LINE HEREINAFTER DESCRIBED;

THENCE WEST ALONG A STRAIGHT LINE PARALLEL WITH THE NORTH LINE OF WEST RANDOLPH STREET, A DISTANCE OF 24.20 TO A POINT;

THENCE SOUTH ALONG A STRAIGHT LINE PERPENDICULAR TO THE NORTH LINE OF WEST RANDOLPH STREET, A DISTANCE OF 1.75 FEET TO A POINT;

THENCE SOUTH WEST ALONG A STRAIGHT LINE, A DISTANCE OF 18.67 FEET TO A POINT, SAID POINT BEING 39.05 FEET WEST OF THE EAST LINE OF THE WEST HALF OF LOT 7 AS MEASURED ALONG A LINE PERPENDICULAR THERETO AND 41.25 FEET NORTH OF THE NORTH LINE OF WEST RANDOLPH STREET, AS MEASURED ALONG A LINE PERPENDICULAR THERETO;

THENCE WEST ALONG A STRAIGHT LINE PARALLEL WITH THE NORTH LINE OF WEST RANDOLPH STREET, A DISTANCE OF 53.22 FEET TO A POINT;

THENCE NORTH ALONG A STRAIGHT LINE PARALLEL WITH THE EAST LINE OF THE WEST HALF OF LOT 7 AFORESAID, A DISTANCE OF 14.95 FEET TO A POINT;

THENCE WEST ALONG A STRAIGHT LINE PARALLEL WITH THE NORTH LINE OF WEST RANDOLPH STREET, A DISTANCE OF 37.86 FEET TO A POINT;

CHICAGO GUARANTEE SURVEY CO.
123 W. MADISON STREET
CHICAGO, IL. 60602
(312)726-6880
9509009 04/08/96

THENCE NORTH ALONG A STRAIGHT LINE PARALLEL WITH THE EAST LINE OF THE WEST HALF OF LOT 7 AFORESAID, A DISTANCE OF 0.41 FEET TO A POINT;

THENCE WEST ALONG A STRAIGHT LINE PARALLEL WITH THE NORTH LINE OF WEST RANDOLPH STREET, A DISTANCE OF 10.38 FEET TO A POINT ON THE EAST LINE OF THE WEST 60.24 FEET OF LOT 5;

AND ALSO;

THAT PART OF THE AFORESAID LAND, PROPERTY AND SPACE LYING ABOVE A HORIZONTAL PLANE HAVING AN ELEVATION OF +1.96 FEET ABOVE CHICAGO CITY DATUM AND BELOW A HORIZONTAL PLANE HAVING AN ELEVATION OF +14.12 FEET ABOVE CHICAGO CITY DATUM AND NORTHERLY OF THE VERTICAL PROJECTION OF THE FOLLOWING DESCRIBED LINE, COMMENCING AT THE POINT OF INTERSECTION OF THE NORTH LINE OF WEST RANDOLPH STREET WITH THE EAST LINE OF THE WEST HALF OF LOT 7 IN BLOCK 36 IN ORIGINAL TOWN OF CHICAGO;

THENCE NORTH ALONG SAID EAST LINE OF THE WEST HALF OF LOT 7 IN BLOCK 36 IN ORIGINAL TOWN OF CHICAGO, A DISTANCE OF 54.44 FEET TO THE POINT OF BEGINNING FOR THE LINE HEREINAFTER DESCRIBED;

THENCE WEST ALONG A STRAIGHT LINE PARALLEL WITH THE NORTH LINE OF WEST RANDOLPH STREET, A DISTANCE OF 24.20 TO A POINT;

THENCE SOUTH ALONG A STRAIGHT LINE PERPENDICULAR TO THE NORTH LINE OF WEST RANDOLPH STREET, A DISTANCE OF 1.75 FEET TO A POINT;

THENCE SOUTHWEST ALONG A STRAIGHT LINE, A DISTANCE OF 18.67 FEET TO A POINT, SAID POINT BEING 39.05 FEET WEST OF THE EAST LINE OF THE WEST HALF OF LOT 7 AS MEASURED ALONG A LINE PERPENDICULAR THERETO AND 41.25 FEET NORTH OF THE NORTH LINE OF WEST RANDOLPH STREET, AS MEASURED ALONG A LINE PERPENDICULAR THERETO;

THENCE WEST ALONG A STRAIGHT LINE PARALLEL WITH THE NORTH LINE OF WEST RANDOLPH STREET, A DISTANCE OF 54.22 FEET TO A POINT;

THENCE NORTH ALONG A STRAIGHT LINE PARALLEL WITH THE EAST LINE OF THE WEST HALF OF LOT 7 AFORESAID, A DISTANCE OF 5.90 FEET TO A POINT;

THENCE WEST ALONG A STRAIGHT LINE PARALLEL WITH THE NORTH LINE OF WEST RANDOLPH STREET, A DISTANCE OF 36.64 FEET TO A POINT;

THENCE NORTH ALONG A STRAIGHT LINE PARALLEL WITH THE EAST LINE OF THE WEST HALF OF LOT 7 AFORESAID, A DISTANCE OF 9.46 FEET TO A POINT;

THENCE WEST ALONG A STRAIGHT LINE PARALLEL WITH THE NORTH LINE OF WEST RANDOLPH STREET, A DISTANCE OF 10.38 FEET TO A POINT ON THE EAST LINE OF THE WEST 60.24 FEET OF LOT 5;

CHICAGO GUARANTEE SURVEY CO.
123 W. MADISON STREET
CHICAGO, IL. 60602
(312)726-6880
9509009 04/08/96

AND ALSO;

THAT PART OF THE AFORESAID LAND, PROPERTY AND SPACE LYING ABOVE A HORIZONTAL PLANE HAVING AN ELEVATION OF +14.12 FEET ABOVE CHICAGO CITY DATUM AND BELOW A HORIZONTAL PLANE HAVING AN ELEVATION OF +26.96 FEET ABOVE CHICAGO CITY DATUM AND WITHIN THE VERTICAL PROJECTION OF THE FOLLOWING DESCRIBED LINE, BEGINNING AT THE POINT OF INTERSECTION OF THE NORTH LINE OF WEST RANDOLPH STREET WITH THE EAST LINE OF THE WEST HALF OF LOT 7 IN BLOCK 36 IN ORIGINAL TOWN OF CHICAGO;

THENCE WEST ALONG SAID NORTH LINE OF WEST RANDOLPH STREET, A DISTANCE OF 49.51 FEET TO A POINT;

THENCE NORTH ALONG A STRAIGHT LINE PARALLEL WITH THE EAST LINE OF THE WEST HALF OF SAID LOT 7, A DISTANCE OF 42.00 FEET TO A POINT;

THENCE WEST ALONG A STRAIGHT LINE PARALLEL WITH THE NORTH LINE OF WEST RANDOLPH STREET, A DISTANCE OF 1.33 FEET TO A POINT;

THENCE NORTH ALONG A STRAIGHT LINE PARALLEL WITH THE EAST LINE OF THE WEST HALF OF SAID LOT 7, A DISTANCE OF 10.00 FEET TO A POINT;

THENCE WESTERLY ALONG A STRAIGHT LINE, A DISTANCE OF 24.80 FEET TO A POINT, SAID POINT BEING 51.99 FEET NORTH OF THE NORTH LINE OF WEST RANDOLPH ST. AS MEASURED ALONG A LINE PERPENDICULAR THERETO;

THENCE WESTERLY ALONG A STRAIGHT LINE, A DISTANCE OF 17.60' TO A POINT, SAID POINT BEING 54.86 FEET NORTH OF THE NORTH LINE OF WEST RANDOLPH ST. AS MEASURED ALONG A LINE PERPENDICULAR THERETO;

THENCE WESTERLY ALONG A STRAIGHT LINE, A DISTANCE OF 16.90' TO A POINT, SAID POINT BEING 59.27 FEET NORTH OF THE NORTH LINE OF WEST RANDOLPH ST. AS MEASURED ALONG A LINE PERPENDICULAR THERETO;

THENCE NORTHWESTERLY ALONG A STRAIGHT LINE, A DISTANCE OF 15.40 TO A POINT, SAID POINT BEING 61.66 FEET NORTH OF THE NORTH LINE OF WEST RANDOLPH ST. AS MEASURED ALONG A LINE PERPENDICULAR THERETO;

THENCE NORTHWESTERLY ALONG A STRAIGHT LINE, A DISTANCE OF 1.30 FEET TO A POINT, SAID POINT BEING 62.93 FEET NORTH OF THE NORTH LINE OF WEST RANDOLPH ST. AS MEASURED ALONG A LINE PERPENDICULAR THERETO;

THENCE WEST ALONG A STRAIGHT LINE PARALLEL WITH THE NORTH LINE OF WEST RANDOLPH STREET, A DISTANCE OF 2.11 FEET TO A POINT;

THENCE NORTH ALONG A STRAIGHT LINE PARALLEL WITH THE EAST LINE OF THE WEST HALF OF SAID LOT 7, A DISTANCE OF 7.44 FEET TO A POINT;

THENCE NORTHWESTERLY ALONG A STRAIGHT LINE, A DISTANCE OF 5.25' TO A POINT, SAID POINT BEING 75.53 FEET NORTH OF THE NORTH LINE OF WEST RANDOLPH ST. AS MEASURED ALONG A LINE PERPENDICULAR THERETO;

CHICAGO GUARANTEE SURVEY CO.
123 W. MADISON STREET
CHICAGO, IL. 60602
(312)726-6880
9509009 04/08/96

THENCE WEST ALONG A STRAIGHT LINE PARALLEL WITH THE NORTH LINE OF WEST RANDOLPH STREET, A DISTANCE OF 4.73 FEET TO A POINT;

THENCE SOUTH ALONG A STRAIGHT LINE PARALLEL WITH THE EAST LINE OF THE WEST HALF OF SAID LOT 7, A DISTANCE OF 2.38 FEET TO A POINT;

THENCE WEST ALONG A STRAIGHT LINE PARALLEL WITH THE NORTH LINE OF WEST RANDOLPH STREET, A DISTANCE OF 7.89 FEET TO A POINT ON THE EAST LINE OF THE WEST 60.24 FEET OF LOT 5 AFORESAID;

THENCE SOUTH ALONG SAID EAST LINE OF THE WEST 60.24 FEET OF LOT 5, A DISTANCE OF 2.54 FEET TO A POINT ON THE LINE 110 FEET 4 INCHES SOUTH OF THE NORTH LINE OF SAID LOT 5;

THENCE WEST ALONG SAID LINE 110 FEET 4 INCHES SOUTH OF THE NORTH LINE OF SAID LOT 5, A DISTANCE OF 22.50 FEET TO A POINT 37 FEET, 8 AND 7/8 INCHES EAST OF THE WEST LINE OF LOT 5;

THENCE NORTH ALONG A STRAIGHT LINE, A DISTANCE OF 109.99 FEET TO A POINT ON THE NORTH LINE OF LOT 5, SAID POINT BEING 38 FEET 11 INCHES EAST OF THE NORTHWEST CORNER OF SAID LOT 5;

THENCE EAST ALONG THE NORTH LINE OF LOTS 5, 6 AND 7 IN BLOCK 36 IN ORIGINAL TOWN OF CHICAGO, A DISTANCE OF 161.71 FEET TO THE EAST LINE OF THE WEST HALF OF SAID LOT 7;

THENCE SOUTH ALONG THE EAST LINE OF THE WEST HALF OF LOT 7, A DISTANCE OF 181.09 FEET TO THE POINT OF BEGINNING.

AND ALSO;

THAT PART OF THE AFORESAID LAND, PROPERTY AND SPACE LYING ABOVE A HORIZONTAL PLANE HAVING AN ELEVATION OF +26.96 FEET ABOVE CHICAGO CITY DATUM AND BELOW A HORIZONTAL PLANE HAVING AN ELEVATION OF +37.93 FEET ABOVE CHICAGO CITY DATUM AND WITHIN THE VERTICAL PROJECTION OF THE FOLLOWING DESCRIBED LINE, BEGINNING AT THE POINT OF INTERSECTION OF THE NORTH LINE OF WEST RANDOLPH STREET WITH THE EAST LINE OF THE WEST HALF OF LOT 7 IN BLOCK 36 IN ORIGINAL TOWN OF CHICAGO;

THENCE WEST ALONG SAID NORTH LINE OF WEST RANDOLPH STREET, A DISTANCE OF 49.51 FEET TO A POINT;

THENCE NORTH ALONG A STRAIGHT LINE PARALLEL WITH THE EAST LINE OF THE WEST HALF OF SAID LOT 7, A DISTANCE OF 42.00 FEET TO A POINT;

THENCE WEST ALONG A STRAIGHT LINE PARALLEL WITH THE NORTH LINE OF WEST RANDOLPH STREET, A DISTANCE OF 1.33 FEET TO A POINT;

THENCE NORTH ALONG A STRAIGHT LINE PARALLEL WITH THE EAST LINE OF

CHICAGO GUARANTEE SURVEY CO.
123 W. MADISON STREET
CHICAGO, IL. 60602
(312)726-6880
9509009 04/08/96

THE WEST HALF OF SAID LOT 7, A DISTANCE OF 10.00 FEET TO A POINT;
THENCE WESTERLY ALONG A STRAIGHT LINE, A DISTANCE OF 24.80' TO A POINT,
SAID POINT BEING 51.99 FEET NORTH OF THE NORTH LINE OF WEST RANDOLPH ST. AS
MEASURED ALONG A LINE PERPENDICULAR THERETO;
THENCE WESTERLY ALONG A STRAIGHT LINE, A DISTANCE OF 17.60' TO A POINT,
SAID POINT BEING 54.86 FEET NORTH OF THE NORTH LINE OF WEST RANDOLPH ST. AS
MEASURED ALONG A LINE PERPENDICULAR THERETO;
THENCE WESTERLY ALONG A STRAIGHT LINE, A DISTANCE OF 16.90' TO A POINT,
SAID POINT BEING 59.27 FEET NORTH OF THE NORTH LINE OF WEST RANDOLPH ST. AS
MEASURED ALONG A LINE PERPENDICULAR THERETO;
THENCE NORTHWESTERLY ALONG A STRAIGHT LINE, A DISTANCE OF 15.40 TO
A POINT, SAID POINT BEING 61.66 FEET NORTH OF THE NORTH LINE OF WEST
RANDOLPH ST. AS MEASURED ALONG A LINE PERPENDICULAR THERETO;
THENCE NORTHWESTERLY ALONG A STRAIGHT LINE, A DISTANCE OF 1.30 FEET
TO A POINT, SAID POINT BEING 62.93 FEET NORTH OF THE NORTH LINE OF WEST
RANDOLPH ST. AS MEASURED ALONG A LINE PERPENDICULAR THERETO;
THENCE WEST ALONG A STRAIGHT LINE PARALLEL WITH THE NORTH LINE OF
WEST RANDOLPH STREET, A DISTANCE OF 2.11 FEET TO A POINT;
THENCE NORTH ALONG A STRAIGHT LINE PARALLEL WITH THE EAST LINE OF
THE WEST HALF OF SAID LOT 7, A DISTANCE OF 7.44 FEET TO A POINT;
THENCE NORTHWESTERLY ALONG A STRAIGHT LINE, A DISTANCE OF 3.47' TO A
POINT, SAID POINT BEING 73.77 FEET NORTH OF THE NORTH LINE OF WEST RANDOLPH
ST. AS MEASURED ALONG A LINE PERPENDICULAR THERETO;
THENCE WEST ALONG A STRAIGHT LINE PARALLEL WITH THE NORTH LINE OF
WEST RANDOLPH STREET, A DISTANCE OF 12.87 FEET TO A POINT ON THE EAST LINE
OF THE WEST 60.24 FEET OF LOT 5 AFORESAID;
THENCE SOUTH ALONG SAID EAST LINE OF THE WEST 60.24 FEET OF LOT 5, A
DISTANCE OF 2.54 FEET TO A POINT ON THE LINE 110 FEET 4 INCHES SOUTH OF THE
NORTH LINE OF SAID LOT 5;
THENCE WEST ALONG SAID LINE 110 FEET 4 INCHES SOUTH OF THE NORTH LINE
OF SAID LOT 5, A DISTANCE OF 22.50 FEET TO A POINT 37 FEET, 8 AND 7/8 INCHES EAST
OF THE WEST LINE OF LOT 5;
THENCE NORTH ALONG A STRAIGHT LINE, A DISTANCE OF 109.99 FEET TO A
POINT ON THE NORTH LINE OF LOT 5, SAID POINT BEING 38 FEET 11 INCHES EAST OF
THE NORTHWEST CORNER OF SAID LOT 5;
THENCE EAST ALONG THE NORTH LINE OF LOTS 5, 6 AND 7 IN BLOCK 36 IN
ORIGINAL TOWN OF CHICAGO, A DISTANCE OF 161.71 FEET TO THE EAST LINE OF THE
WEST HALF OF SAID LOT 7;

THENCE SOUTH ALONG THE EAST LINE OF THE WEST HALF OF LOT 7, A DISTANCE OF 181.09 FEET TO THE POINT OF BEGINNING.

AND ALSO;

THAT PART OF THE AFORESAID LAND, PROPERTY AND SPACE LYING ABOVE A HORIZONTAL PLANE HAVING AN ELEVATION OF +37.93 FEET ABOVE CHICAGO CITY DATUM AND BELOW A HORIZONTAL PLANE HAVING AN ELEVATION OF 60.00 FEET ABOVE CHICAGO CITY DATUM AND WITHIN THE VERTICAL PROJECTION OF THE FOLLOWING DESCRIBED LINE, BEGINNING AT THE POINT OF INTERSECTION OF THE NORTH LINE OF WEST RANDOLPH STREET WITH THE EAST LINE OF THE WEST HALF OF LOT 7 IN BLOCK 36 IN ORIGINAL TOWN OF CHICAGO;

THENCE WEST ALONG SAID NORTH LINE OF WEST RANDOLPH STREET, A DISTANCE OF 49.51 FEET TO A POINT;

THENCE NORTH ALONG A STRAIGHT LINE PARALLEL WITH THE EAST LINE OF THE WEST HALF OF SAID LOT 7, A DISTANCE OF 42.00 FEET TO A POINT;

THENCE WEST ALONG A STRAIGHT LINE PARALLEL WITH THE NORTH LINE OF WEST RANDOLPH STREET, A DISTANCE OF 1.33 FEET TO A POINT;

THENCE NORTH ALONG A STRAIGHT LINE PARALLEL WITH THE EAST LINE OF THE WEST HALF OF SAID LOT 7, A DISTANCE OF 10.00 FEET TO A POINT;

THENCE WESTERLY ALONG A STRAIGHT LINE, A DISTANCE OF 24.80' TO A POINT, SAID POINT BEING 51.99 FEET NORTH OF THE NORTH LINE OF WEST RANDOLPH ST. AS MEASURED ALONG A LINE PERPENDICULAR THERETO;

THENCE WESTERLY ALONG A STRAIGHT LINE, A DISTANCE OF 17.60' TO A POINT, SAID POINT BEING 54.86 FEET NORTH OF THE NORTH LINE OF WEST RANDOLPH ST. AS MEASURED ALONG A LINE PERPENDICULAR THERETO;

THENCE WESTERLY ALONG A STRAIGHT LINE, A DISTANCE OF 16.90' TO A POINT, SAID POINT BEING 59.27 FEET NORTH OF THE NORTH LINE OF WEST RANDOLPH ST. AS MEASURED ALONG A LINE PERPENDICULAR THERETO;

THENCE NORTHWESTERLY ALONG A STRAIGHT LINE, A DISTANCE OF 15.40 TO A POINT, SAID POINT BEING 61.66 FEET NORTH OF THE NORTH LINE OF WEST RANDOLPH ST. AS MEASURED ALONG A LINE PERPENDICULAR THERETO;

THENCE NORTHWESTERLY ALONG A STRAIGHT LINE, A DISTANCE OF 1.30 FEET TO A POINT, SAID POINT BEING 62.93 FEET NORTH OF THE NORTH LINE OF WEST RANDOLPH ST. AS MEASURED ALONG A LINE PERPENDICULAR THERETO;

THENCE WEST ALONG A STRAIGHT LINE PARALLEL WITH THE NORTH LINE OF WEST RANDOLPH STREET, A DISTANCE OF 2.11 FEET TO A POINT;

THENCE NORTH ALONG A STRAIGHT LINE PARALLEL WITH THE EAST LINE OF THE WEST HALF OF SAID LOT 7, A DISTANCE OF 7.44 FEET TO A POINT;

CHICAGO GUARANTEE SURVEY CO.
123 W. MADISON STREET
CHICAGO, IL. 60602
(312)726-6880
9509009 04/08/96

THENCE NORTHWESTERLY ALONG A STRAIGHT LINE, A DISTANCE OF 3.47' TO A POINT, SAID POINT BEING 73.77 FEET NORTH OF THE NORTH LINE OF WEST RANDOLPH ST. AS MEASURED ALONG A LINE PERPENDICULAR THERETO;

THENCE WEST ALONG A STRAIGHT LINE PARALLEL WITH THE NORTH LINE OF WEST RANDOLPH STREET, A DISTANCE OF 12.87 FEET TO A POINT ON THE EAST LINE OF THE WEST 60.24 FEET OF LOT 5 AFORESAID;

THENCE SOUTH ALONG SAID EAST LINE OF THE WEST 60.24 FEET OF LOT 5, A DISTANCE OF 2.54 FEET TO A POINT ON THE LINE 110 FEET 4 INCHES SOUTH OF THE NORTH LINE OF SAID LOT 5;

THENCE WEST ALONG SAID LINE 110 FEET 4 INCHES SOUTH OF THE NORTH LINE OF SAID LOT 5, A DISTANCE OF 22.50 FEET TO A POINT 37 FEET, 8 AND 7/8 INCHES EAST OF THE WEST LINE OF LOT 5;

THENCE NORTH ALONG A STRAIGHT LINE, A DISTANCE OF 109.99 FEET TO A POINT ON THE NORTH LINE OF LOT 5, SAID POINT BEING 38 FEET 11 INCHES EAST OF THE NORTHWEST CORNER OF SAID LOT 5;

THENCE EAST ALONG THE NORTH LINE OF LOTS 5, 6 AND 7 IN BLOCK 36 IN ORIGINAL TOWN OF CHICAGO, A DISTANCE OF 161.71 FEET TO THE EAST LINE OF THE WEST HALF OF SAID LOT 7;

THENCE SOUTH ALONG THE EAST LINE OF THE WEST HALF OF LOT 7, A DISTANCE OF 181.09 FEET TO THE POINT OF BEGINNING.

AND ALSO;

THAT PART OF THE AFORESAID LAND, PROPERTY AND SPACE LYING ABOVE A HORIZONTAL PLANE HAVING AN ELEVATION OF 60.00 FEET ABOVE CHICAGO CITY DATUM AND BELOW A HORIZONTAL PLANE HAVING AN ELEVATION OF 88.35 FEET ABOVE CHICAGO CITY DATUM AND WITHIN THE VERTICAL PROJECTION OF THE FOLLOWING DESCRIBED LINE, COMMENCING AT THE POINT OF INTERSECTION OF THE NORTH LINE OF WEST RANDOLPH STREET WITH THE EAST LINE OF THE WEST HALF OF LOT 7 IN BLOCK 36 IN ORIGINAL TOWN OF CHICAGO;

THENCE NORTH ALONG THE EAST LINE OF THE WEST HALF OF SAID LOT 7, A DISTANCE OF 49.55 FEET TO THE POINT OF BEGINNING;

THENCE WEST ALONG A STRAIGHT LINE PARALLEL WITH THE NORTH LINE OF WEST RANDOLPH STREET, A DISTANCE OF 6.36 FEET TO A POINT;

THENCE NORTHWESTERLY ALONG A STRAIGHT LINE, A DISTANCE OF 6.31 FEET TO A POINT, SAID POINT BEING 53.84 FEET NORTH OF THE NORTH LINE OF WEST RANDOLPH STREET AS MEASURED ALONG A LINE PERPENDICULAR THERETO;

THENCE SOUTH ALONG A STRAIGHT LINE PARALLEL WITH THE EAST LINE OF THE WEST HALF OF SAID LOT 7, A DISTANCE OF 5.51 FEET TO A POINT;

CHICAGO GUARANTEE SURVEY CO.
123 W. MADISON STREET
CHICAGO, IL. 60602
(312)726-6880
9509009 04/08/96

THENCE WEST ALONG A STRAIGHT LINE PARALLEL WITH THE NORTH LINE OF WEST RANDOLPH STREET, A DISTANCE OF 6.87 FEET TO A POINT;

THENCE SOUTH ALONG A STRAIGHT LINE PARALLEL WITH THE EAST LINE OF THE WEST HALF OF SAID LOT 7 , A DISTANCE OF 6.33 FEET TO A POINT, SAID POINT BEING 42.00 FEET NORTH OF THE NORTH LINE OF WEST RANDOLPH STREET AS MEASURED ALONG A LINE PERPENDICULAR THERETO;

THENCE WEST ALONG A STRAIGHT LINE PARALLEL WITH THE NORTH LINE OF WEST RANDOLPH STREET, A DISTANCE OF 32.84 FEET TO A POINT;

THENCE NORTH ALONG A STRAIGHT LINE PARALLEL WITH THE EAST LINE OF THE WEST HALF OF SAID LOT 7 , A DISTANCE OF 10.00 FEET TO A POINT;

THENCE WESTERLY ALONG A STRAIGHT LINE, A DISTANCE OF 24.80 FEET TO A POINT, SAID POINT BEING 51.99 FEET NORTH OF THE NORTH LINE OF WEST RANDOLPH ST. AS MEASURED ALONG A LINE PERPENDICULAR THERETO;

THENCE WESTERLY ALONG A STRAIGHT LINE, A DISTANCE OF 17.60' TO A POINT, SAID POINT BEING 54.86 FEET NORTH OF THE NORTH LINE OF WEST RANDOLPH ST. AS MEASURED ALONG A LINE PERPENDICULAR THERETO;

THENCE WESTERLY ALONG A STRAIGHT LINE, A DISTANCE OF 16.90' TO A POINT, SAID POINT BEING 59.27 FEET NORTH OF THE NORTH LINE OF WEST RANDOLPH ST. AS MEASURED ALONG A LINE PERPENDICULAR THERETO;

THENCE NORTHWESTERLY ALONG A STRAIGHT LINE, A DISTANCE OF 15.40 TO A POINT, SAID POINT BEING 61.66 FEET NORTH OF THE NORTH LINE OF WEST RANDOLPH ST. AS MEASURED ALONG A LINE PERPENDICULAR THERETO;

THENCE NORTHWESTERLY ALONG A STRAIGHT LINE, A DISTANCE OF 1.30 FEET TO A POINT, SAID POINT BEING 62.93 FEET NORTH OF THE NORTH LINE OF WEST RANDOLPH ST. AS MEASURED ALONG A LINE PERPENDICULAR THERETO;

THENCE WEST ALONG A STRAIGHT LINE PARALLEL WITH THE NORTH LINE OF WEST RANDOLPH STREET, A DISTANCE OF 2.11 FEET TO A POINT;

THENCE NORTH ALONG A STRAIGHT LINE PARALLEL WITH THE EAST LINE OF THE WEST HALF OF SAID LOT 7 , A DISTANCE OF 7.44 FEET TO A POINT;

THENCE NORTHWESTERLY ALONG A STRAIGHT LINE, A DISTANCE OF 3.47' TO A POINT, SAID POINT BEING 73.77 FEET NORTH OF THE NORTH LINE OF WEST RANDOLPH ST. AS MEASURED ALONG A LINE PERPENDICULAR THERETO;

THENCE WEST ALONG A STRAIGHT LINE PARALLEL WITH THE NORTH LINE OF WEST RANDOLPH STREET, A DISTANCE OF 12.87 FEET TO A POINT ON THE EAST LINE OF THE WEST 60.24 FEET OF LOT 5 AFORESAID;

THENCE SOUTH ALONG SAID EAST LINE OF THE WEST 60.24 FEET OF LOT 5, A DISTANCE OF 2.54 FEET TO A POINT ON THE LINE 110 FEET 4 INCHES SOUTH OF THE NORTH LINE OF SAID LOT 5;

CHICAGO GUARANTEE SURVEY CO.
123 W. MADISON STREET
CHICAGO, IL. 60602
(312)726-6880
9509009 04/08/96

THENCE WEST ALONG SAID LINE 110 FEET 4 INCHES SOUTH OF THE NORTH LINE OF SAID LOT 5, A DISTANCE OF 22.50 FEET TO A POINT 37 FEET, 8 AND 7/8 INCHES EAST OF THE WEST LINE OF LOT 5;

THENCE NORTH ALONG A STRAIGHT LINE, A DISTANCE OF 109.99 FEET TO A POINT ON THE NORTH LINE OF LOT 5, SAID POINT BEING 38 FEET 11 INCHES EAST OF THE NORTHWEST CORNER OF SAID LOT 5;

THENCE EAST ALONG THE NORTH LINE OF LOTS 5, 6 AND 7 IN BLOCK 36 IN ORIGINAL TOWN OF CHICAGO, A DISTANCE OF 161.71 FEET TO THE EAST LINE OF THE WEST HALF OF SAID LOT 7;

THENCE SOUTH ALONG THE EAST LINE OF THE WEST HALF OF LOT 7, A DISTANCE OF 131.54 FEET TO THE POINT OF BEGINNING.

AND ALSO;

THAT PART OF THE AFORESAID LAND, PROPERTY AND SPACE LYING ABOVE A HORIZONTAL PLANE HAVING AN ELEVATION OF 88.35 FEET ABOVE CHICAGO CITY DATUM AND BELOW A HORIZONTAL PLANE HAVING AN ELEVATION OF 103.93 FEET ABOVE CHICAGO CITY DATUM AND WITHIN THE VERTICAL PROJECTION OF THE FOLLOWING DESCRIBED BOUNDARY, COMMENCING AT THE POINT OF INTERSECTION OF THE NORTH LINE OF WEST RANDOLPH STREET WITH THE EAST LINE OF THE WEST 60.24 FEET OF SAID LOT 5 IN BLOCK 36 IN ORIGINAL TOWN OF CHICAGO;

THENCE NORTH ALONG SAID EAST LINE OF THE WEST 60.24 FEET OF LOT 5 IN BLOCK 36 IN ORIGINAL TOWN OF CHICAGO, A DISTANCE OF 71.26 FEET TO THE POINT OF BEGINNING FOR THE AFORESAID LAND, PROPERTY AND SPACE HEREIN AFTER DESCRIBED;

THENCE WEST ALONG A STRAIGHT LINE PARALLEL WITH THE NORTH LINE OF SAID LOT 5, A DISTANCE OF 22.50 FEET TO A POINT, SAID POINT BEING 37 FEET 8 AND 7/8 INCHES EAST OF THE WEST LINE OF SAID LOT 5;

THENCE NORTH ALONG A STRAIGHT LINE, A DISTANCE OF 109.99 FEET TO THE NORTH LINE OF LOT 5 IN BLOCK 36 IN ORIGINAL TOWN OF CHICAGO, SAID POINT BEING 38 FEET 11 INCHES EAST OF THE NORTHWEST CORNER OF SAID LOT 5 AS MEASURED ALONG THE NORTH LINE OF SAID LOT 5;

THENCE EAST ALONG SAID NORTH LINE OF LOT 5, A DISTANCE OF 35.41 FEET TO A POINT;

THENCE SOUTH ALONG A STRAIGHT LINE, A DISTANCE OF 109.99 FEET TO A POINT ON THE HEREINBEFORE DESCRIBED LINE PARALLEL WITH THE NORTH LINE OF LOT 5 IN BLOCK 36 IN ORIGINAL TOWN OF CHICAGO;

THENCE WEST ALONG SAID PARALLEL LINE, A DISTANCE OF 13.93 FEET TO THE POINT OF BEGINNING.

CHICAGO GUARANTEE SURVEY CO.
123 W. MADISON STREET
CHICAGO, IL. 60602
(312)726-6880
9509009 04/08/96

AND ALSO

THAT PART OF THE AFORESAID LAND, PROPERTY AND SPACE LYING ABOVE A HORIZONTAL PLANE HAVING AN ELEVATION OF FEET 103.93 ABOVE CHICAGO CITY DATUM AND WITHIN THE VERTICAL PROJECTION OF THE FOLLOWING DESCRIBED BOUNDARY, COMMENCING AT THE POINT OF INTERSECTION OF THE NORTH LINE OF WEST RANDOLPH STREET WITH THE EAST LINE OF THE WEST 60.24 FEET OF SAID LOT 5 IN BLOCK 36 IN ORIGINAL TOWN OF CHICAGO;

THENCE NORTH ALONG SAID EAST LINE OF THE WEST 60.24 FEET OF LOT 5 IN BLOCK 36 IN ORIGINAL TOWN OF CHICAGO, A DISTANCE OF 71.26 FEET TO THE POINT OF BEGINNING FOR THE AFORESAID LAND, PROPERTY AND SPACE HEREIN AFTER DESCRIBED;

THENCE WEST ALONG A STRAIGHT LINE PARALLEL WITH THE NORTH LINE OF SAID LOT 5, A DISTANCE OF 22.50 FEET TO A POINT, SAID POINT BEING 37 FEET 8 AND 7/8 INCHES EAST OF THE WEST LINE OF SAID LOT 5;

THENCE NORTH ALONG A STRAIGHT LINE, A DISTANCE OF 109.99 FEET TO THE NORTH LINE OF LOT 5 IN BLOCK 36 IN ORIGINAL TOWN OF CHICAGO, SAID POINT BEING 38 FEET 11 INCHES EAST OF THE NORTHWEST CORNER OF SAID LOT 5 AS MEASURED ALONG THE NORTH LINE OF SAID LOT 5;

THENCE EAST ALONG SAID NORTH LINE OF LOT 5, A DISTANCE OF 21.40 FEET TO A POINT;

THENCE SOUTH ALONG A STRAIGHT LINE, A DISTANCE OF 109.99 FEET TO THE POINT OF BEGINNING.

ALL IN THE CITY OF CHICAGO, COOK COUNTY ILLINOIS.

PARCEL 2 (RETAIL PARCEL)

THAT PART OF THE LAND, PROPERTY AND SPACE IN THE WEST ONE HALF OF LOT 7 IN BLOCK 36 IN ORIGINAL TOWN OF CHICAGO TOGETHER WITH ALL OF LOTS 5 AND 6 (SAID LOTS 5 AND 6 IN BLOCK 36 BEING ALSO KNOWN AS LOTS 2 THRU 12 IN ASSESSOR'S DIVISION OF LOTS 5, 6 AND 8 IN BLOCK 36 IN ORIGINAL TOWN OF CHICAGO) IN SAID BLOCK 36 IN ORIGINAL TOWN OF CHICAGO IN SECTION 9, TOWNSHIP 39 NORTH, RANGE 14 EAST OF THE THIRD PRINCIPAL MERIDIAN, EXCEPT THAT PORTION OF THE WEST 60.24 FEET OF SAID LOT 5 LYING SOUTH OF A LINE 110 FEET SOUTH OF THE NORTH LINE OF SAID LOT 5 AND EXCEPT ALSO THAT PORTION WESTERLY OF A LINE COMMENCING AT A POINT ON THE NORTH LINE OF SAID LOT 5, 38 FEET 11 INCHES EAST OF THE NORTHWEST CORNER OF SAID LOT 5 AND RUNNING SOUTH THROUGH A POINT, WHICH AT A DISTANCE OF 110 FEET 4 INCHES (MEASURED ALONG THE WEST LINE OF SAID LOT 5) SOUTH OF THE NORTH LINE OF SAID LOT 5 IS 37 FEET 7-7/8 INCHES EAST OF THE WEST LINE OF SAID LOT 5, BOUNDED AND DESCRIBED AS FOLLOWS:

CHICAGO GUARANTEE SURVEY CO.
123 W. MADISON STREET
CHICAGO, IL. 60602
(312)726-6880
9509009 04/08/96

ALL THAT PART OF THE AFORESAID LAND, PROPERTY AND SPACE LYING BELOW A HORIZONTAL PLANE HAVING AN ELEVATION OF +1.96' ABOVE CHICAGO CITY DATUM AND SOUTHERLY OF THE VERTICAL PROJECTION OF THE FOLLOWING DESCRIBED LINE, COMMENCING AT THE POINT OF INTERSECTION OF THE NORTH LINE OF WEST RANDOLPH STREET WITH THE EAST LINE OF THE WEST HALF OF LOT 7 IN BLOCK 36 IN ORIGINAL TOWN OF CHICAGO;

THENCE NORTH ALONG SAID EAST LINE OF THE WEST HALF OF LOT 7 IN BLOCK 36 IN ORIGINAL TOWN OF CHICAGO, A DISTANCE OF 54.44 FEET TO THE POINT OF BEGINNING FOR THE LINE HEREINAFTER DESCRIBED;

THENCE WEST ALONG A STRAIGHT LINE PARALLEL WITH THE NORTH LINE OF WEST RANDOLPH STREET, A DISTANCE OF 24.20 TO A POINT;

THENCE SOUTH ALONG A STRAIGHT LINE PERPENDICULAR TO THE NORTH LINE OF WEST RANDOLPH STREET, A DISTANCE OF 1.75 FEET TO A POINT;

THENCE SOUTH WEST ALONG A STRAIGHT LINE, A DISTANCE OF 18.67 FEET TO A POINT, SAID POINT BEING 39.05 FEET WEST OF THE EAST LINE OF THE WEST HALF OF LOT 7 AS MEASURED ALONG A LINE PERPENDICULAR THERETO AND 41.25 FEET NORTH OF THE NORTH LINE OF WEST RANDOLPH STREET, AS MEASURED ALONG A LINE PERPENDICULAR THERETO;

THENCE WEST ALONG A STRAIGHT LINE PARALLEL WITH THE NORTH LINE OF WEST RANDOLPH STREET, A DISTANCE OF 53.22 FEET TO A POINT;

THENCE SOUTH ALONG A STRAIGHT LINE PARALLEL WITH THE EAST LINE OF THE WEST HALF OF LOT 7 AFORESAID, A DISTANCE OF 8.07 FEET TO A POINT;

THENCE WEST ALONG A STRAIGHT LINE PARALLEL WITH THE NORTH LINE OF WEST RANDOLPH STREET, A DISTANCE OF 12.88 FEET TO A POINT;

THENCE SOUTH ALONG A STRAIGHT LINE PARALLEL WITH THE EAST LINE OF THE WEST HALF OF LOT 7 AFORESAID, A DISTANCE OF 11.45 FEET TO A POINT;

THENCE WEST ALONG A STRAIGHT LINE PARALLEL WITH THE NORTH LINE OF WEST RANDOLPH STREET, A DISTANCE OF 9.13 FEET TO A POINT;

THENCE NORTH ALONG A STRAIGHT LINE PARALLEL WITH THE EAST LINE OF THE WEST HALF OF LOT 7 AFORESAID, A DISTANCE OF 11.45 FEET TO A POINT;

THENCE WEST ALONG A STRAIGHT LINE PARALLEL WITH THE NORTH LINE OF WEST RANDOLPH STREET, A DISTANCE OF 11.98 FEET TO A POINT;

THENCE NORTH ALONG A STRAIGHT LINE PARALLEL WITH THE EAST LINE OF THE WEST HALF OF LOT 7 AFORESAID, A DISTANCE OF 13.97 FEET TO A POINT;

THENCE WEST ALONG A STRAIGHT LINE PARALLEL WITH THE NORTH LINE OF WEST RANDOLPH STREET, A DISTANCE OF 4.31 FEET TO A POINT;

THENCE SOUTH ALONG A STRAIGHT LINE PARALLEL WITH THE EAST LINE OF THE WEST HALF OF LOT 7 AFORESAID, A DISTANCE OF 24.78 FEET TO A POINT;

CHICAGO GUARANTEE SURVEY CO.
123 W. MADISON STREET
CHICAGO, IL. 60602
(312)726-6880
9509009 04/08/96

THENCE WEST ALONG A STRAIGHT LINE PARALLEL WITH THE NORTH LINE OF WEST RANDOLPH STREET, A DISTANCE OF 4.31 FEET TO A POINT ON THE EAST LINE OF THE WEST 60.24 FEET OF LOT 5;

AND ALSO;

THAT PART OF THE AFORESAID LAND, PROPERTY AND SPACE LYING ABOVE A HORIZONTAL PLANE HAVING AN ELEVATION OF +1.96 FEET ABOVE CHICAGO CITY DATUM AND BELOW A HORIZONTAL PLANE HAVING AN ELEVATION OF +14.12 FEET ABOVE CHICAGO CITY DATUM AND SOUTHERLY OF THE VERTICAL PROJECTION OF THE FOLLOWING DESCRIBED LINE, COMMENCING AT THE POINT OF INTERSECTION OF THE NORTH LINE OF WEST RANDOLPH STREET WITH THE EAST LINE OF THE WEST HALF OF LOT 7 IN BLOCK 36 IN ORIGINAL TOWN OF CHICAGO;

THENCE NORTH ALONG SAID EAST LINE OF THE WEST HALF OF LOT 7 IN BLOCK 36 IN ORIGINAL TOWN OF CHICAGO, A DISTANCE OF 54.44 FEET TO THE POINT OF BEGINNING FOR THE LINE HEREINAFTER DESCRIBED;

THENCE WEST ALONG A STRAIGHT LINE PARALLEL WITH THE NORTH LINE OF WEST RANDOLPH STREET, A DISTANCE OF 24.20 TO A POINT;

THENCE SOUTH ALONG A STRAIGHT LINE PERPENDICULAR TO THE NORTH LINE OF WEST RANDOLPH STREET, A DISTANCE OF 1.75 FEET TO A POINT;

THENCE SOUTH WEST ALONG A STRAIGHT LINE, A DISTANCE OF 18.67 FEET TO A POINT, SAID POINT BEING 39.05 FEET WEST OF THE EAST LINE OF THE WEST HALF OF LOT 7 AS MEASURED ALONG A LINE PERPENDICULAR THERETO AND 41.25 FEET NORTH OF THE NORTH LINE OF WEST RANDOLPH STREET, AS MEASURED ALONG A LINE PERPENDICULAR THERETO;

THENCE WEST ALONG A STRAIGHT LINE PARALLEL WITH THE NORTH LINE OF WEST RANDOLPH STREET, A DISTANCE OF 54.22 FEET TO A POINT;

THENCE NORTH ALONG A STRAIGHT LINE PARALLEL WITH THE EAST LINE OF THE WEST HALF OF LOT 7 AFORESAID, A DISTANCE OF 5.90 FEET TO A POINT;

THENCE WEST ALONG A STRAIGHT LINE PARALLEL WITH THE NORTH LINE OF WEST RANDOLPH STREET, A DISTANCE OF 12.00 FEET TO A POINT;

THENCE SOUTH ALONG A STRAIGHT LINE PARALLEL WITH THE EAST LINE OF THE WEST HALF OF LOT 7 AFORESAID, A DISTANCE OF 25.42 FEET TO A POINT;

THENCE WEST ALONG A STRAIGHT LINE PARALLEL WITH THE NORTH LINE OF WEST RANDOLPH STREET, A DISTANCE OF 9.13 FEET TO A POINT;

THENCE NORTH ALONG A STRAIGHT LINE PARALLEL WITH THE EAST LINE OF THE WEST HALF OF LOT 7 AFORESAID, A DISTANCE OF 25.42 FEET TO A POINT;

THENCE WEST ALONG A STRAIGHT LINE PARALLEL WITH THE NORTH LINE OF

CHICAGO GUARANTEE SURVEY CO.
123 W. MADISON STREET
CHICAGO, IL. 60602
(312)726-6880
9509009 04/08/96

WEST RANDOLPH STREET, A DISTANCE OF 16.09 FEET TO A POINT ;
THENCE SOUTH ALONG A STRAIGHT LINE PARALLEL WITH THE EAST LINE OF THE
WEST HALF OF LOT 7 AFORESAID, A DISTANCE OF 24.78 FEET TO A POINT;
THENCE WEST ALONG A STRAIGHT LINE PARALLEL WITH THE NORTH LINE OF
WEST RANDOLPH STREET, A DISTANCE OF 9.81 FEET TO A POINT ON THE EAST LINE OF
THE WEST 60.24 FEET OF LOT 5;

AND ALSO;

THAT PART OF THE AFORESAID LAND, PROPERTY AND SPACE LYING ABOVE A
HORIZONTAL PLANE HAVING AN ELEVATION OF +14.12 FEET ABOVE CHICAGO CITY
DATUM AND BELOW A HORIZONTAL PLANE HAVING AN ELEVATION OF +26.96 FEET
ABOVE CHICAGO CITY DATUM AND WITHIN THE VERTICAL PROJECTION OF THE
FOLLOWING DESCRIBED LINE, COMMENCING AT THE POINT OF INTERSECTION OF THE
NORTH LINE OF WEST RANDOLPH STREET WITH THE EAST LINE OF THE WEST HALF OF
LOT 7 IN BLOCK 36 IN ORIGINAL TOWN OF CHICAGO;

THENCE WEST ALONG THE NORTH LINE OF WEST RANDOLPH STREET, A
DISTANCE OF 49.51 FEET TO THE POINT OF BEGINNING FOR THE LAND PROPERTY AND
SPACE HEREINAFTER DESCRIBED:

THENCE NORTH ALONG A STRAIGHT LINE PARALLEL WITH THE EAST LINE OF
THE WEST HALF OF SAID LOT 7 , A DISTANCE OF 42.00 FEET TO A POINT;

THENCE WEST ALONG A STRAIGHT LINE PARALLEL WITH THE NORTH LINE OF
WEST RANDOLPH STREET, A DISTANCE OF 10.96 FEET TO A POINT;

THENCE SOUTH ALONG A STRAIGHT LINE PARALLEL WITH THE EAST LINE OF
THE WEST HALF OF SAID LOT 7 , A DISTANCE OF 8.52 FEET TO A POINT;

THENCE WEST ALONG A STRAIGHT LINE PARALLEL WITH THE NORTH LINE OF
WEST RANDOLPH STREET, A DISTANCE OF 14.70 FEET TO A POINT;

THENCE NORTHWESTERLY ALONG A STRAIGHT LINE, A DISTANCE OF 5.04 TO A
POINT, SAID POINT BEING 36.91 NORTH OF THE NORTH LINE OF WEST RANDOLPH
STREET AS MEASURED ALONG A LINE PERPENDICULAR THERETO;

THENCE NORTH ALONG A STRAIGHT LINE PARALLEL WITH THE EAST LINE OF
THE WEST HALF OF SAID LOT 7 , A DISTANCE OF 5.08 FEET TO A POINT ON A LINE 42.00
FEET NORTH OF AND PARALLEL WITH THE NORTH LINE OF WEST RANDOLPH STREET;

THENCE WEST ALONG A STRAIGHT LINE PARALLEL WITH THE NORTH LINE
OF WEST RANDOLPH STREET, A DISTANCE OF 2.73 FEET TO A POINT;

THENCE NORTHWESTERLY ALONG A STRAIGHT LINE, A DISTANCE OF 23.50 FEET
TO A POINT, SAID POINT BEING 47.49 FEET NORTH OF THE NORTH LINE OF WEST
RANDOLPH ST. AS MEASURED ALONG A LINE PERPENDICULAR THERETO;

THENCE WEST ALONG A STRAIGHT LINE PARALLEL WITH THE NORTH LINE OF

CHICAGO GUARANTEE SURVEY CO.
123 W. MADISON STREET
CHICAGO, IL. 60602
(312)726-6880
9509009 04/08/96

WEST RANDOLPH STREET, A DISTANCE OF 1.02 FEET TO A POINT;
THENCE SOUTH ALONG A STRAIGHT LINE PARALLEL WITH THE EAST LINE OF THE WEST HALF OF SAID LOT 7, A DISTANCE OF 6.60 FEET TO A POINT;
THENCE EAST ALONG A STRAIGHT LINE PARALLEL WITH THE NORTH LINE OF WEST RANDOLPH STREET, A DISTANCE OF 5.85 FEET TO A POINT;
THENCE SOUTH ALONG A STRAIGHT LINE PARALLEL WITH THE EAST LINE OF THE WEST HALF OF SAID LOT 7, A DISTANCE OF 25.27 FEET TO A POINT;
THENCE WEST ALONG A STRAIGHT LINE PARALLEL WITH THE NORTH LINE OF WEST RANDOLPH STREET, A DISTANCE OF 14.57 FEET TO A POINT;
THENCE SOUTH ALONG A STRAIGHT LINE PARALLEL WITH THE EAST LINE OF THE WEST HALF OF SAID LOT 7, A DISTANCE OF 15.63 FEET TO A POINT ON THE NORTH LINE OF WEST RANDOLPH STREET;
THENCE EAST ALONG THE NORTH LINE OF WEST RANDOLPH STREET, A DISTANCE OF 64.72 FEET TO THE POINT OF BEGINNING.

AND ALSO;

THAT PART OF THE AFORESAID LAND, PROPERTY AND SPACE LYING ABOVE A HORIZONTAL PLANE HAVING AN ELEVATION OF +26.96 FEET ABOVE CHICAGO CITY DATUM AND BELOW A HORIZONTAL PLANE HAVING AN ELEVATION OF +37.93 FEET ABOVE CHICAGO CITY DATUM AND WITHIN THE VERTICAL PROJECTION OF THE FOLLOWING DESCRIBED LINE, COMMENCING AT THE POINT OF INTERSECTION OF THE NORTH LINE OF WEST RANDOLPH STREET WITH THE EAST LINE OF THE WEST HALF OF LOT 7 IN BLOCK 36 IN ORIGINAL TOWN OF CHICAGO;

THENCE WEST ALONG THE NORTH LINE OF WEST RANDOLPH STREET, A DISTANCE OF 49.51 FEET TO THE POINT OF BEGINNING FOR THE LAND PROPERTY AND SPACE HEREINAFTER DESCRIBED:

THENCE NORTH ALONG A STRAIGHT LINE PARALLEL WITH THE EAST LINE OF THE WEST HALF OF SAID LOT 7, A DISTANCE OF 24.26 FEET TO A POINT;

THENCE WEST ALONG A STRAIGHT LINE PARALLEL WITH THE NORTH LINE OF WEST RANDOLPH STREET, A DISTANCE OF 10.35 FEET TO A POINT;

THENCE NORTHWESTERLY ALONG A STRAIGHT LINE, A DISTANCE OF 3.55 TO A POINT, SAID POINT BEING 26.93 NORTH OF THE NORTH LINE OF WEST RANDOLPH STREET AS MEASURED ALONG A LINE PERPENDICULAR THERETO;

THENCE NORTH ALONG A STRAIGHT LINE PARALLEL WITH THE EAST LINE OF THE WEST HALF OF SAID LOT 7, A DISTANCE OF 6.46 FEET TO A POINT;

THENCE WEST ALONG A STRAIGHT LINE PARALLEL WITH THE NORTH LINE OF WEST RANDOLPH STREET, A DISTANCE OF 8.91 FEET TO A POINT;

THENCE NORTH ALONG A STRAIGHT LINE PARALLEL WITH THE EAST LINE OF

CHICAGO GUARANTEE SURVEY CO.
123 W. MADISON STREET
CHICAGO, IL. 60602
(312)726-6880
9509009 04/08/96

THE WEST HALF OF SAID LOT 7 , A DISTANCE OF 8.52 FEET TO A POINT;

THENCE WEST ALONG A STRAIGHT LINE PARALLEL WITH THE NORTH LINE OF WEST RANDOLPH STREET, A DISTANCE OF 10.43 FEET TO A POINT;

THENCE NORTHWESTERLY ALONG A STRAIGHT LINE, A DISTANCE OF 12.65 FEET TO A POINT, SAID POINT BEING 44.71 FEET NORTH OF THE NORTH LINE OF WEST RANDOLPH ST. AS MEASURED ALONG A LINE PERPENDICULAR THERETO;

THENCE SOUTH ALONG A STRAIGHT LINE PARALLEL WITH THE EAST LINE OF THE WEST HALF OF SAID LOT 7 , A DISTANCE OF 22.31 FEET TO A POINT;

THENCE WEST ALONG A STRAIGHT LINE PARALLEL WITH THE NORTH LINE OF WEST RANDOLPH STREET, A DISTANCE OF 21.34 FEET TO A POINT;

THENCE NORTH ALONG A STRAIGHT LINE PARALLEL WITH THE EAST LINE OF THE WEST HALF OF SAID LOT 7 , A DISTANCE OF 28.41 FEET TO A POINT;

THENCE NORTHWESTERLY ALONG A STRAIGHT LINE, A DISTANCE OF 7.80 FEET TO A POINT, SAID POINT BEING 56.44 FEET NORTH OF THE NORTH LINE OF WEST RANDOLPH ST. AS MEASURED ALONG A LINE PERPENDICULAR THERETO;

THENCE WEST ALONG A STRAIGHT LINE PARALLEL WITH THE NORTH LINE OF WEST RANDOLPH STREET, A DISTANCE OF 10.32 FEET TO A POINT;

THENCE SOUTH ALONG A STRAIGHT LINE PARALLEL WITH THE EAST LINE OF THE WEST HALF OF SAID LOT 7 , A DISTANCE OF 34.39 FEET TO A POINT;

THENCE WEST ALONG A STRAIGHT LINE PARALLEL WITH THE NORTH LINE OF WEST RANDOLPH STREET, A DISTANCE OF 10.00 FEET TO A POINT ON THE EAST LINE OF THE WEST 60.24 FEET OF LOT 5;

THENCE SOUTH ALONG SAID EAST LINE OF THE WEST 60.24 FEET OF LOT 5, A DISTANCE OF 21.78 FEET TO A POINT ON THE NORTH LINE OF WEST RANDOLPH STREET;

THENCE EAST ALONG THE NORTH LINE OF WEST RANDOLPH STREET, A DISTANCE OF 90.83 FEET TO THE POINT OF BEGINNING.

ALL IN THE CITY OF CHICAGO, COOK COUNTY ILLINOIS.

EXHIBIT B

(Permitted Title Exceptions)

EXHIBIT B

**QUITCLAIM
DEED**

Grantor, the **CITY OF CHICAGO**, an Illinois municipal corporation ("Grantor"), having its principal office at 121 North LaSalle Street, Chicago, Illinois 60602, for and in consideration of **TEN and NO/100 DOLLARS (\$10.00)**, conveys and quitclaims, pursuant to ordinance adopted March 26, 1996 (C.J.P. pgs. 18982-19054), to **LIVENT REALTY (CHICAGO), INC.**, a Delaware corporation ("Grantee"), having its principal office at 165 Avenue Road, Toronto, Ontario, Canada M5R 3S4, all interest and title of Grantor in the following described real property ("Property"):

THAT PART OF LOT 5 IN BLOCK 36 IN ORIGINAL TOWN OF CHICAGO IN SECTION 9, TOWNSHIP 39 NORTH, RANGE 14, EAST OF THE THIRD PRINCIPAL MERIDIAN, DESCRIBED AS FOLLOWS:

BEGINNING AT A POINT ON THE WEST LINE OF SAID LOT 5, ON DEARBORN STREET, 110 FEET SOUTH OF THE NORTHWEST CORNER THEREOF; THENCE EAST PARALLEL TO THE NORTH LINE OF SAID LOT, 37 FEET, 8 - 7/8THS INCHES; THENCE NORTH 110 FEET, MORE OR LESS, TO A POINT ON THE NORTH LINE OF SAID LOT 5, 38 FEET AND 11 INCHES EAST OF THE NORTHWEST CORNER THEREOF; THENCE WEST ALONG THE NORTH LINE OF SAID LOT 5, 38 FEET, 11 INCHES, TO THE NORTHWEST CORNER; THENCE SOUTH ALONG THE WEST LINE OF SAID LOT, ON DEARBORN STREET FRONT THEREOF; TO PLACE OF BEGINNING, IN COOK COUNTY, ILLINOIS

Commonly known as: 157 North Dearborn Street,
Chicago, Illinois

Permanent Index No.: 17-09-439-001-0000

Further, this quitclaim deed ("Deed") is made and executed upon, and is subject to certain express conditions and covenants hereinafter contained, said conditions and covenants being a part of the consideration for the Property and are to be taken and construed as running with the land, and Grantee hereby binds itself and its successors, assigns, grantees and lessees to these covenants and conditions, which covenants and conditions are as follows:

FIRST: Grantee shall devote the Property only to the uses authorized by Grantor and specified in the applicable provisions of: (i) that certain Redevelopment Plan for "Blighted Commercial Area North Loop" ("Plan"), (ii) that certain Tax Increment Redevelopment Plan and Redevelopment Project for North Loop Redevelopment Project ("TIF Plan"), and (iii) the terms and provisions of that certain agreement known as "Block 36, North Loop Project Redevelopment Agreement, Oriental Theater" ("Agreement") entered into between Grantor and Grantee as of April ____, 1996 and recorded with the Office of the Recorder of Deeds of Cook County, Illinois on _____, 1996, as document #_____. Specifically, in accordance with the terms of the Agreement, Grantee shall develop the Property in conjunction with the redevelopment of the Oriental Theater and the construction of other improvements constituting the Project, but shall maintain the facade of the building improving the Property in conjunction with its status as a Chicago landmark, pursuant to the terms of that certain ordinance adopted by the City Council of the City of Chicago on May 9, 1984, as corrected

by that certain ordinance adopted July 9, 1984 ("Landmarks Ordinance"), and also in accordance with the terms and conditions described in that certain preservation easement ("Preservation Easement") between the City of Chicago and Chicago Title and Trust Company Trust #53891, which easement is dated as of December 14, 1983 and recorded with the Office of the Recorder of Deeds of Cook County, Illinois as document #26910729.

SECOND: Grantee shall pay real estate taxes and assessments on the Property or any part thereof when due. Prior to the issuance by Grantor of a Certificate of Completion (as hereinafter defined), Grantee shall not encumber the Property, except to secure financing as is permitted in subsection 4.8 of the Agreement. Grantee shall not suffer or permit any levy or attachment to be made or any other encumbrance or lien to attach to the Property until Grantor issues a Certificate of Completion (unless Grantee has taken such appropriate action to cause the Title Company (as such term is described in the Agreement) to insure over any title encumbrances caused by such liens or claims).

THIRD: Grantee shall commence and complete the construction of the Project in accordance with the time period described in subsection 4.10 of the Agreement.

FOURTH: Unless otherwise permitted by subsection 8.2 of the Agreement, until Grantor issues the Certificate, Grantee shall have no right to convey any right, title or interest in the Property without the prior written approval of Grantor.

FIFTH: Grantee agrees for itself and any successor in interest not to discriminate based upon race, religion, color, sex, national origin or ancestry, age, handicap, sexual orientation, military status, parental status or source of income in the use of any theater, commercial, retail, or office space located within the Project improvements.

SIXTH: During the construction of the Project, Grantee shall comply with those certain employment obligations and hiring covenants as further described in Section VI of the Agreement.

SEVENTH: Upon the issuance of the Certificate of Completion and for the entire Term of the Agreement, Grantee shall comply with the Use and Performance Covenants listed in Section VII of the Agreement, and with the terms and conditions of the Public Benefits Agreement and the Agreement to Provide Assistance to the Chicago School Board of Trustees, which are attached to the Agreement as Exhibits L and M.

The covenants and agreements contained in the covenant numbered **FIRST** and **SEVENTH** shall terminate on the expiration date of the Plan and the TIF Plan. The covenants and agreements contained in the covenant numbered **FIFTH** shall remain without any limitation as to time. The covenants and agreements contained in covenants numbered **SECOND**, **THIRD**, **FOURTH** and **SIXTH** shall terminate on the date Grantor issues the Certificate of Completion as herein provided except that the termination of the covenant numbered **SECOND** shall in no way be construed to release Grantee from its obligation to pay real estate taxes and assessments on the Property or any part thereof, and further,

except that the termination of the covenant numbered **SIXTH** shall in no way be construed as to release Grantee from its Hiring Covenants made to Grantor (as further described in section 7.3 of the Agreement).

In the event that subsequent to the conveyance of the Property and prior to delivery of the Certificate of Completion by Grantor, Grantee defaults in or breaches any of the terms or conditions described in the Agreement or the covenants contained in this Deed which have not been cured or remedied within the period and in the manner provided for in the Agreement, the Deed, or both, Grantor may re-enter and take possession of the Property, terminate the estate conveyed by the Deed to Grantee as well as Grantee's right of title and all other rights and interests in and to the Property conveyed by the Deed to Grantee, and re-vest title in said Property with the City; provided, however, that said re-vesting of title in the City shall always be limited by, and shall not defeat, render invalid, or limit in any way, the lien of the First Mortgage (as defined in the Agreement) for the protection of the holders of the First Mortgage.

Notwithstanding any of the provisions of the Deed or the Agreement, including but not limited to those which are intended to be covenants running with the land, the holder of the First Mortgage or a holder who obtains title to the Property as a result of foreclosure of the First Mortgage shall not be obligated by the provisions of the Deed or the Agreement to construct or complete the construction of the Project or to guarantee such construction or completion, nor shall any covenant or any other

provision in the Deed or the Agreement be construed to so obligate such holder. Nothing in this section or any section or provision of the Agreement or the Deed shall be construed to permit any such holder to devote the Property or any part thereof to a use or to construct improvements thereon other than those permitted in the Agreement.

Promptly after the completion of construction of the Project improving the Property, in accordance with the terms of the Agreement, Grantor shall furnish Grantee with an appropriate instrument in accordance with the terms of the Agreement ("Certificate of Completion"). The Certificate of Completion shall be a conclusive determination of satisfaction and termination of the agreements and covenants contained in the Agreement and in the Deed with respect to the construction of the Project and the dates for beginning and completion thereof.

The Certificate of Completion shall be in such form as will enable it to be recorded in the proper office for the recordation of deeds and other instruments pertaining to the Property. If Grantor shall refuse or fail to provide the Certificate of Completion, Grantor, within thirty (30) days after written request by Grantee, shall provide Grantee with a written statement indicating in adequate detail what acts or measures will be necessary, in the opinion of Grantor, for Grantee to take or perform in order to obtain the Certificate of Completion.

IN WITNESS WHEREOF, Grantor has caused this instrument to be duly executed in its name and behalf and its seal to be hereunto duly affixed and attested, by the Mayor and by the City Clerk, on or as of the _____ day of _____, _____.

CITY OF CHICAGO, a
municipal corporation

BY:

RICHARD M. DALEY, Mayor

ATTEST:

_____, City Clerk

THIS INSTRUMENT PREPARED BY, AND
AFTER RECORDING, PLEASE RETURN TO:

Assistant Corporation Counsel
Real Estate & Land Use Division
City of Chicago
121 North LaSalle Street, Room 610
Chicago, Illinois 60602

STATE OF ILLINOIS)
) SS
COUNTY OF C O O K)

I, _____, a Notary Public in and for said County, in the State aforesaid, do hereby certify that James J. Laski, personally known to me to be the City Clerk of the City of Chicago, a municipal corporation, and personally known to me to be the same person whose name is subscribed to the foregoing instrument, appeared before me this day in person, and being first duly sworn by me acknowledged that as Clerk, he signed and delivered the said instrument and caused the corporate seal of said corporation to be affixed thereto, pursuant to authority given by the City of Chicago, as his free and voluntary act, and as the free and voluntary act and deed of said corporation, for the uses and purposes therein set forth.

GIVEN under my hand and notarial seal this _____ day of _____, 199_____.

NOTARY PUBLIC

(S E A L)

My commission expires _____.

EXHIBIT C

PERMITTED EXCEPTIONS

I. Oliver Property

1. The terms and conditions of that certain Special Service Area affecting the Central Area Circulator, as further described in that certain document recorded as document #91075841.
2. Agreement between Arthur T. Lyman, A. Lawrence Lowell and George R. Harris, as trustees under instrument recorded as document #1156092, and D. Percy Morgan, and Iroquois Theater Company, a Corporation of New Jersey, dated May 1, 1903; appended to another agreement dated May 1, 1903; recorded September 19, 1904, as document #3594111; the former agreement relating to the construction and maintenance of a system of caissons extending under the north wall of the building located mainly on premises south and adjoining the land and under the south wall of the building on the land.
3. Agreement between Arthur T. Lyman and A. Lawrence Lowell and George R. Harris, as trustees under trust instrument dated July 26, 1889, and recorded September 14, 1889, as document #1156092, and Metropolis Theater Company, a Corporation of New York, which agreement was dated November 1, 1906, and recorded November 20, 1906, as document #3956583, and was modified by instrument made by the same parties, dated November 1, 1906, and recorded November 20, 1906, as document #3955689, relating to a party wall on a line described as commencing at a point on the north line of Lot 5, 38 feet, 11 inches, east of the northwest corner, and running to a point on the south line of the north 110 feet, 4 inches, of said Lot 5, 37 feet, 8 7/8 inches, east of the west line thereof.
4. Declaration of architectural facade easement and conservation right dated December 14, 1983, and recorded December 28, 1983, as document #26910729, made by Chicago Title and Trust Company, as trustee under trust #53891, to the City of Chicago, a municipal corporation, restricting the grantor from demolishing or altering the exterior facade of the building on the land, and obliging the grantor to maintain the facade of the building.
5. Terms and conditions of that certain Redevelopment Agreement between the City of Chicago and Livent Realty (Chicago), Inc. dated as of April ____, 1996 and recorded on _____, 1996 as document #_____.

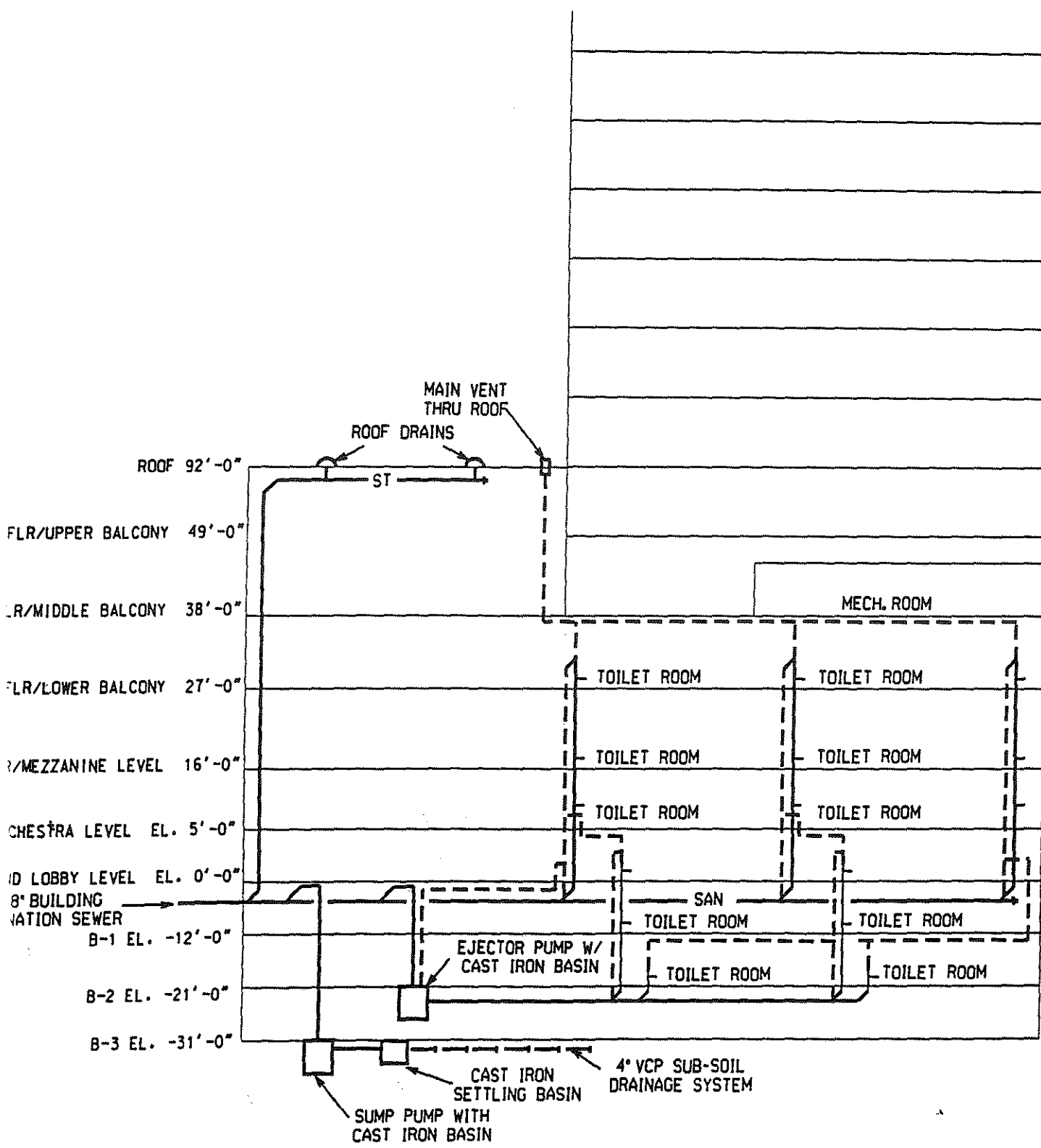

ORIENTAL THEATER

SANITARY WASTE AND VENT SYSTEMS DIAGRAM

5 MARCH 1996

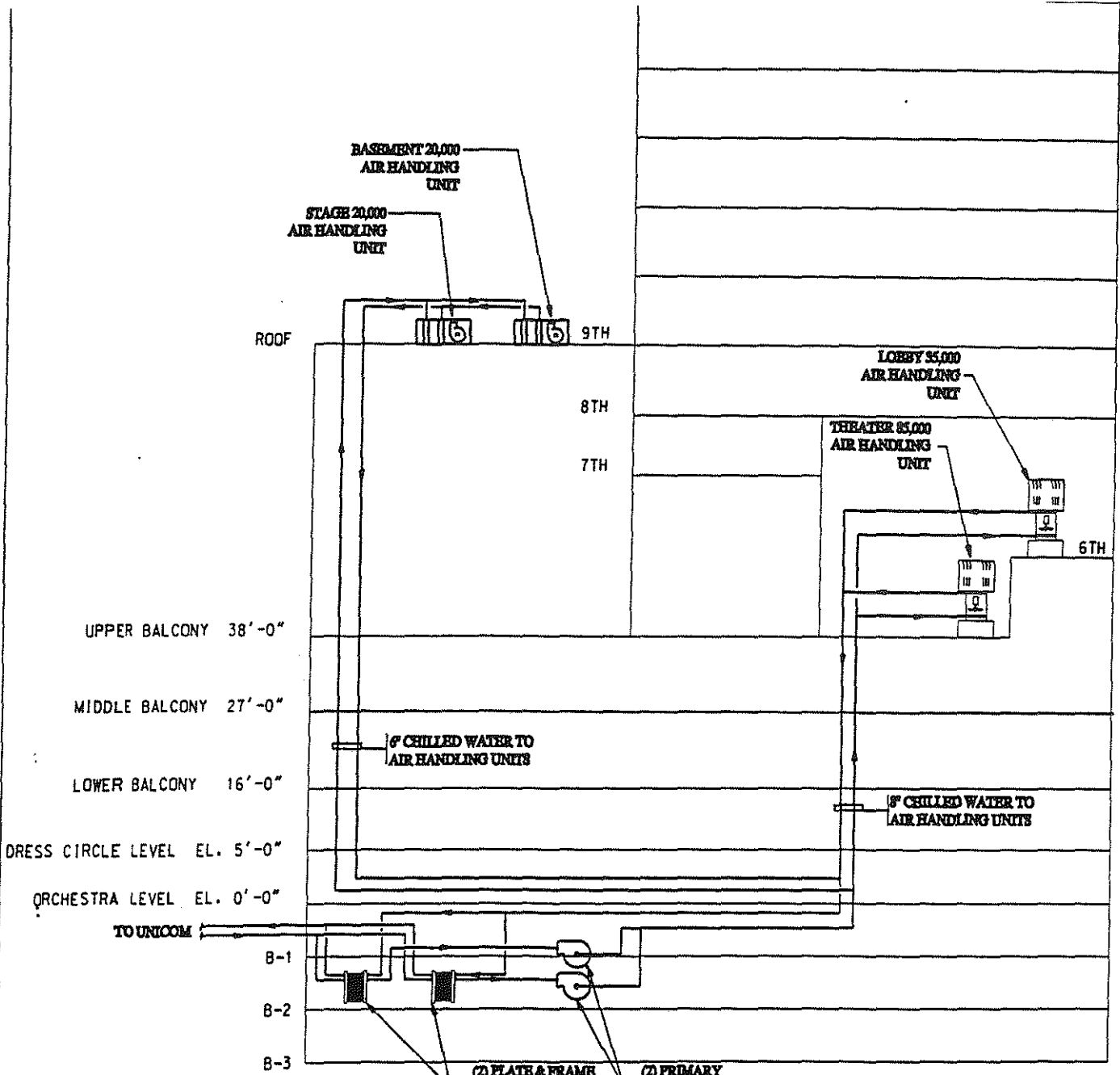

**ORIENTAL THEATER
CHILLED WATER SYSTEMS DIAGRAM**

28 FEBRUARY, 1996

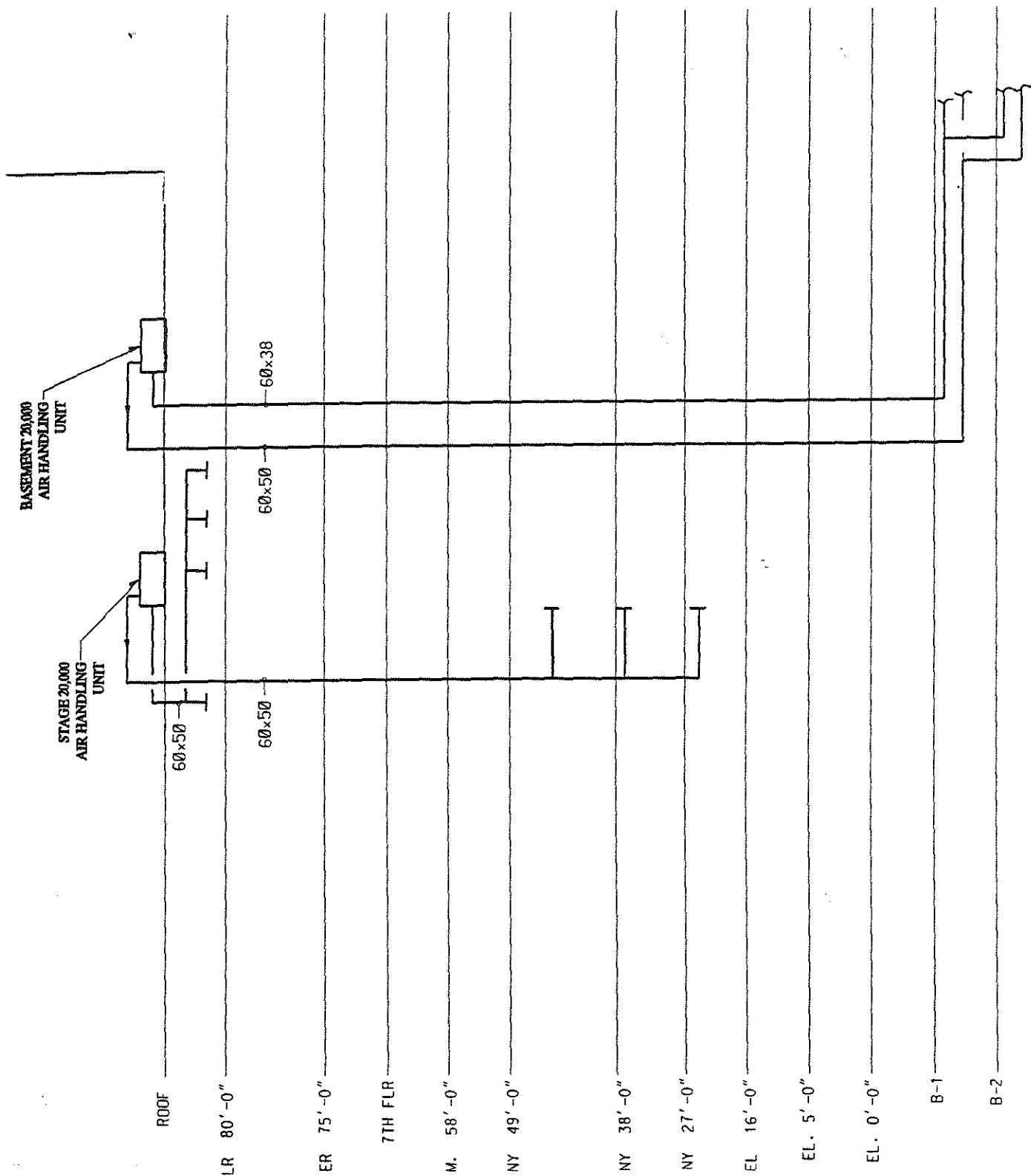

MECHANICAL AT FIFTH AVENUE

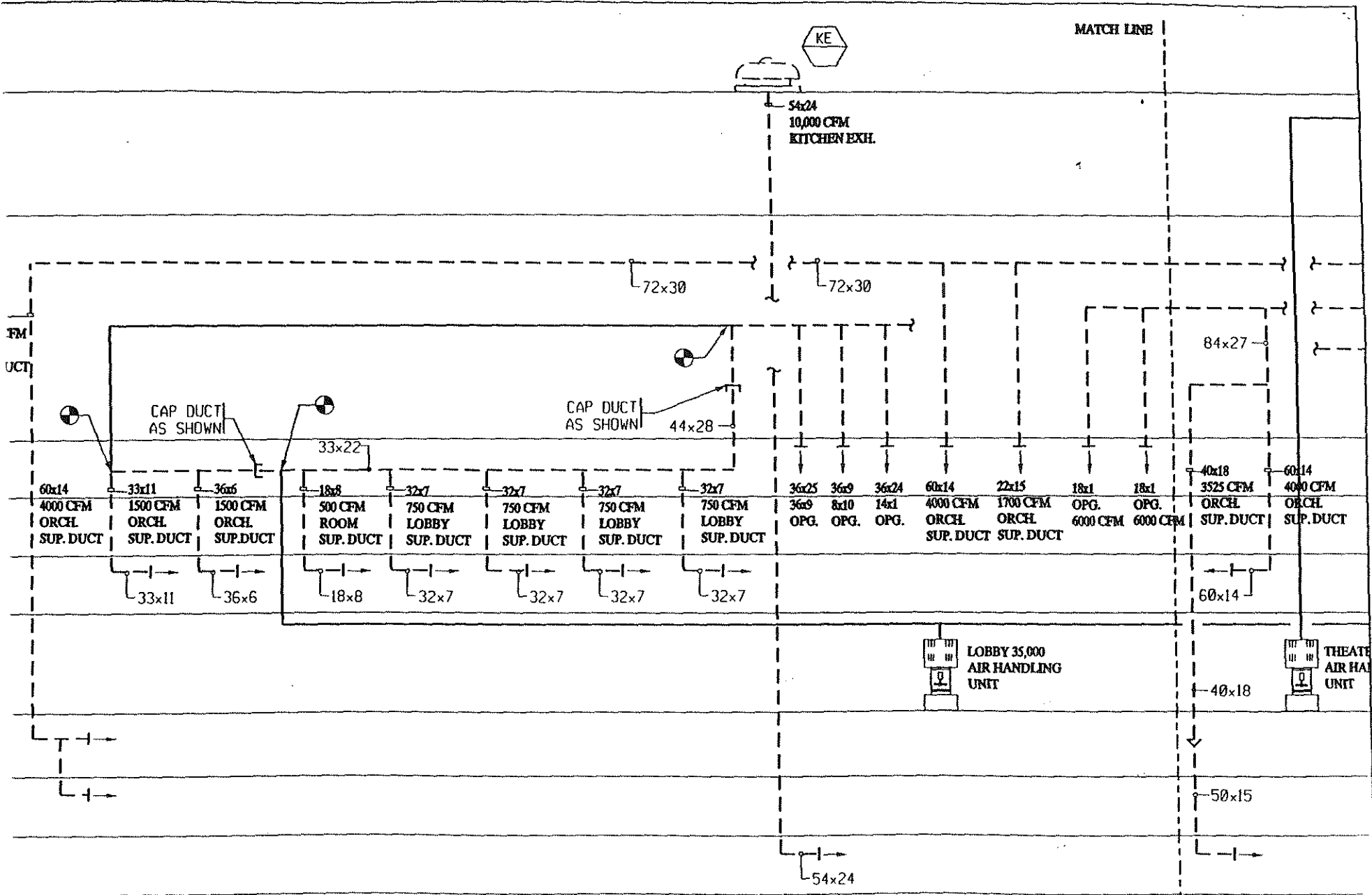

**Environmental
Systems Design, Inc.
Consulting Engineers**

55 East Monroe Street
Suite 1660
Chicago, Illinois 60603

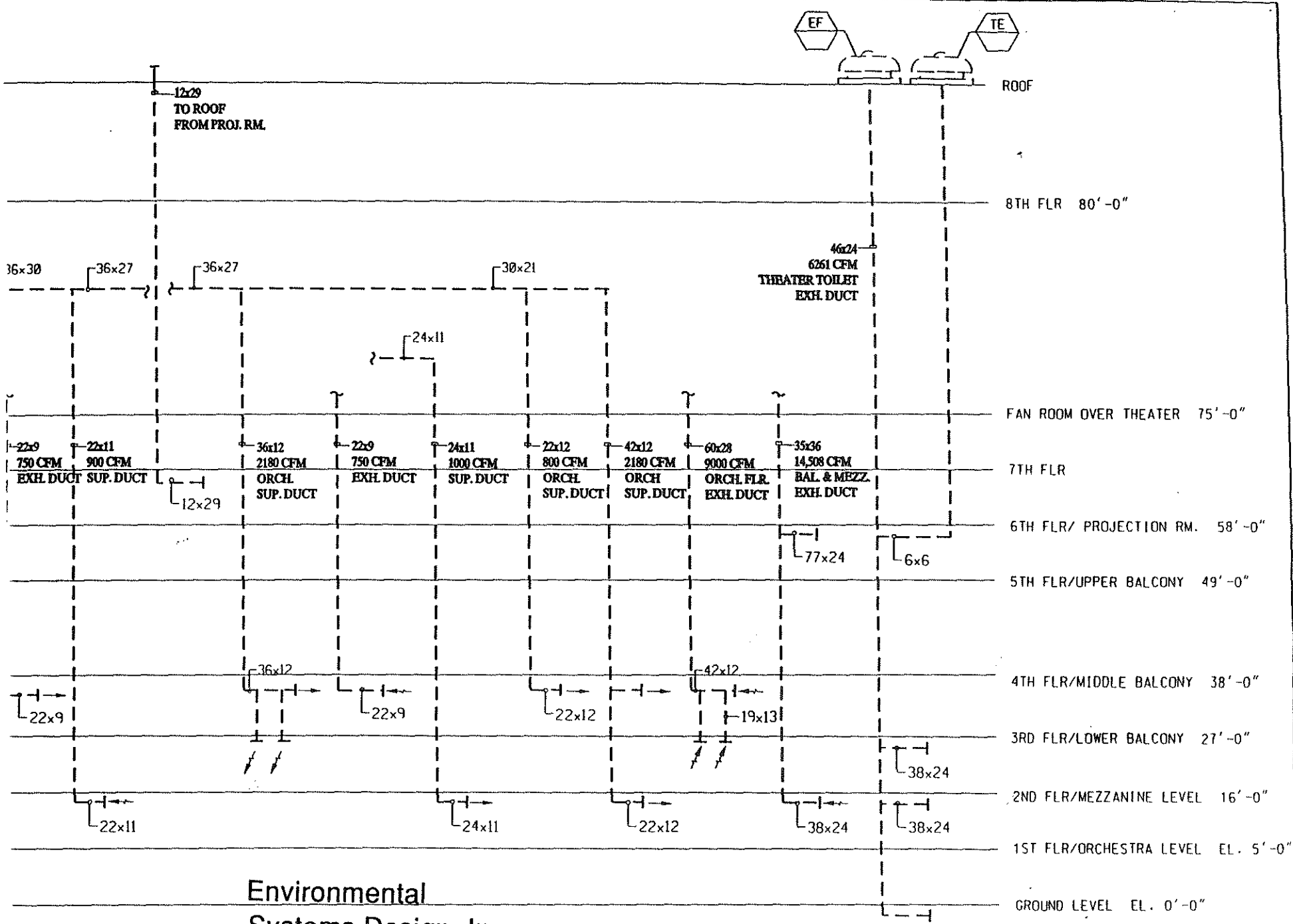

Environmental
Systems Design, Inc.
Consulting Engineers

55 East Monroe Street
Suite 1680

Project:
**Oriental
 Theater
 Redevelopment**

24 West Randolph
 Chicago, Illinois

Owner:
Livent (U.S.) Inc.

Sub 000
 355 Avenue Road
 Toronto, Ontario M5R 2V7

Project Manager:
Kofman Engineering, Ltd.

Sub 201
 355 Avenue Road
 Toronto, Ontario M5R 2S4
 (416) 223 - 7155

Architect:
**Daniel P. Coffey
 & Associates, Ltd.**

Sub 0759
 220 South Wacker Drive
 Chicago, Illinois 60606
 (312) 352 - 2850

Structural Engineer:
Yolles Partnership

Sub 300
 193 Queen St. East
 Toronto, Ontario M5A 1B7

Mechanical/Electrical Engineer:
**Environmental
 System Design, Inc.**

Sub 1000
 85 East Moreau
 Chicago, Illinois 60620

Acoustical Engineer:
**John Swallow
 Associates**

220 Oakley Boulevard
 Bethesda, Ontario M4W 3P8
 Engineer:

No. REVISION DATE

2ND BASEMENT PLAN

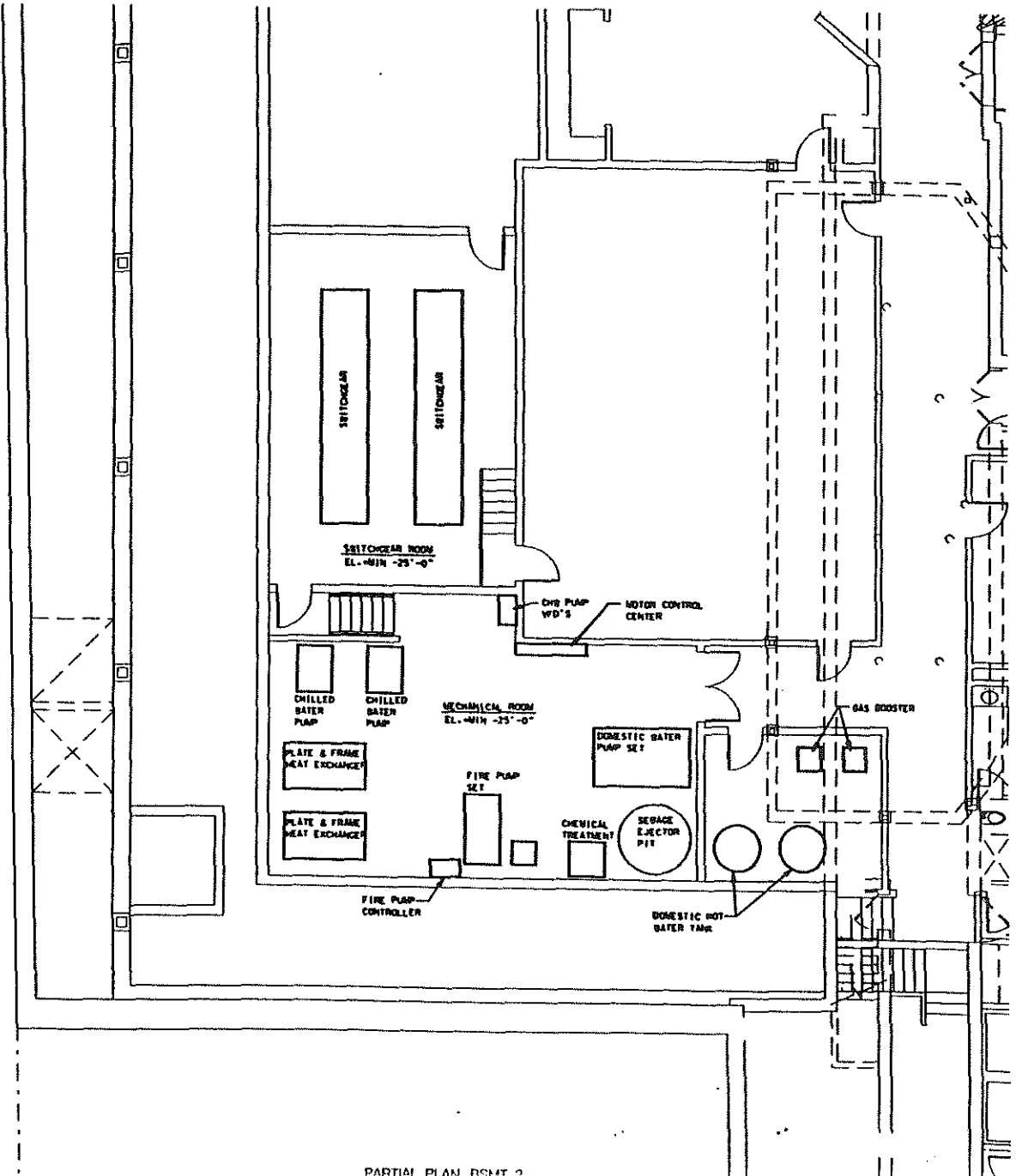

PARTIAL PLAN BSMT 2

Oriental Theater

24 West Randolph
Chicago, Illinois

Client:
Livent (U.S.) Inc.

Architect:
S. H. Smith & Associates
Chicago, Illinois

Engineer:
Johnson Engineering, Ltd.
Chicago, Illinois

Date: 01/15/87
Project No.: 87-001

Scale: 1/8" = 1'-0"

Sheet No.: 101

Project Name: Oriental Theater

Client Name: Livent (U.S.) Inc.

Project Address: 24 West Randolph, Chicago, IL

Project Description: Roof Plan

Project Status: Design

Project Phase: Preliminary

Project Budget: \$1,000,000

Project Location: Chicago, IL

Project Contact: John Smith

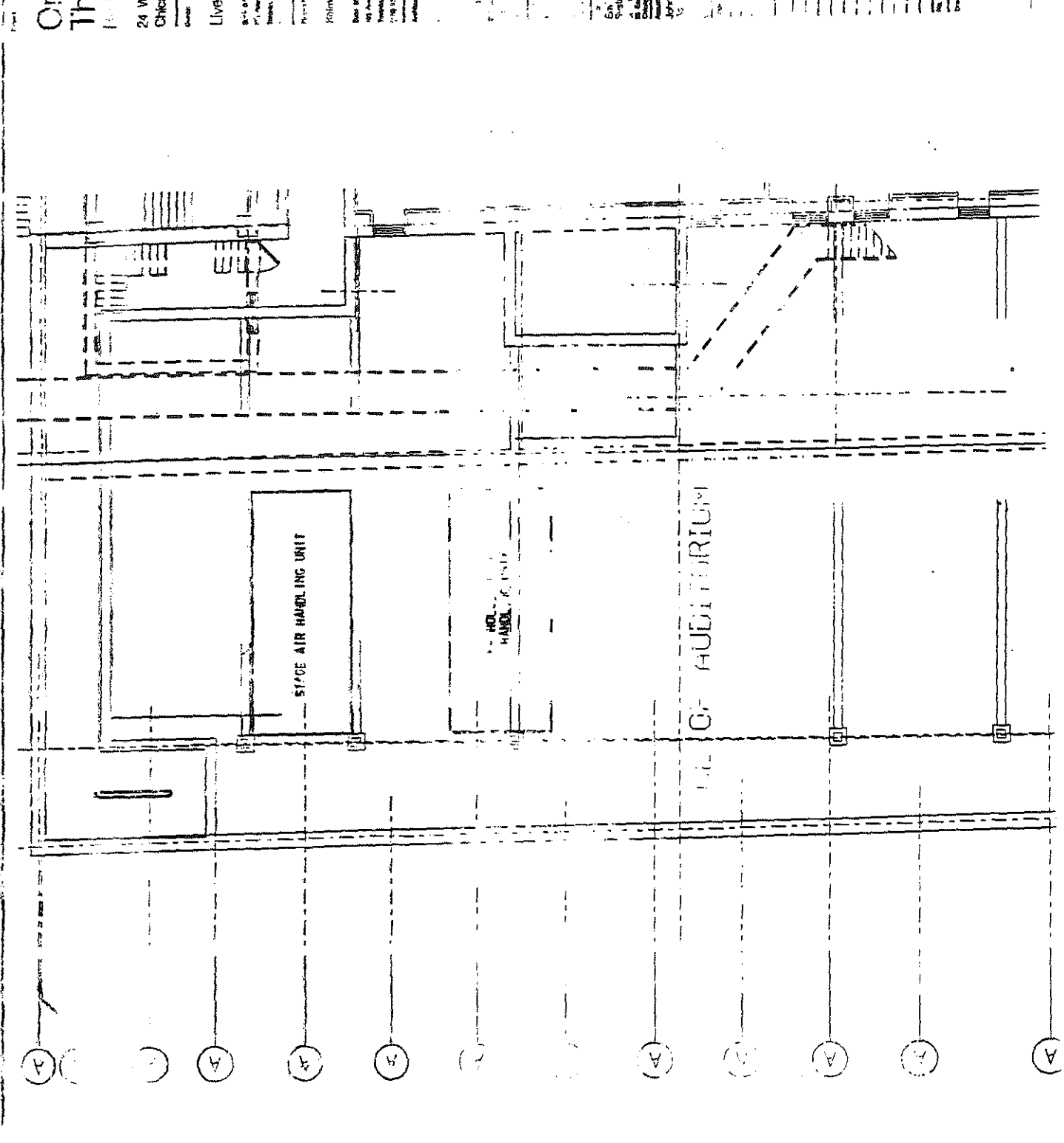

ROOF PLAN

ENVIRONMENTAL SYSTEMS DESIGN, INC.
CONSULTING ENGINEERS

55 EAST MONROE STREET SUITE 1660 CHICAGO, IL 60603
(312) 372-1200

FAN ROOM SECTION

EXHAUST DUCT TO
COLLECT PLACE LOUVER

SUPPLY FAN
OUTLET SILENCER

OUTSIDE AIR DUCT (15' x 8')
UP 100' TO ROOF
RETURN/EXHAUST FAN (TYP #2)

LOBBY AHU
INLET SILENCER

THEATER AHU

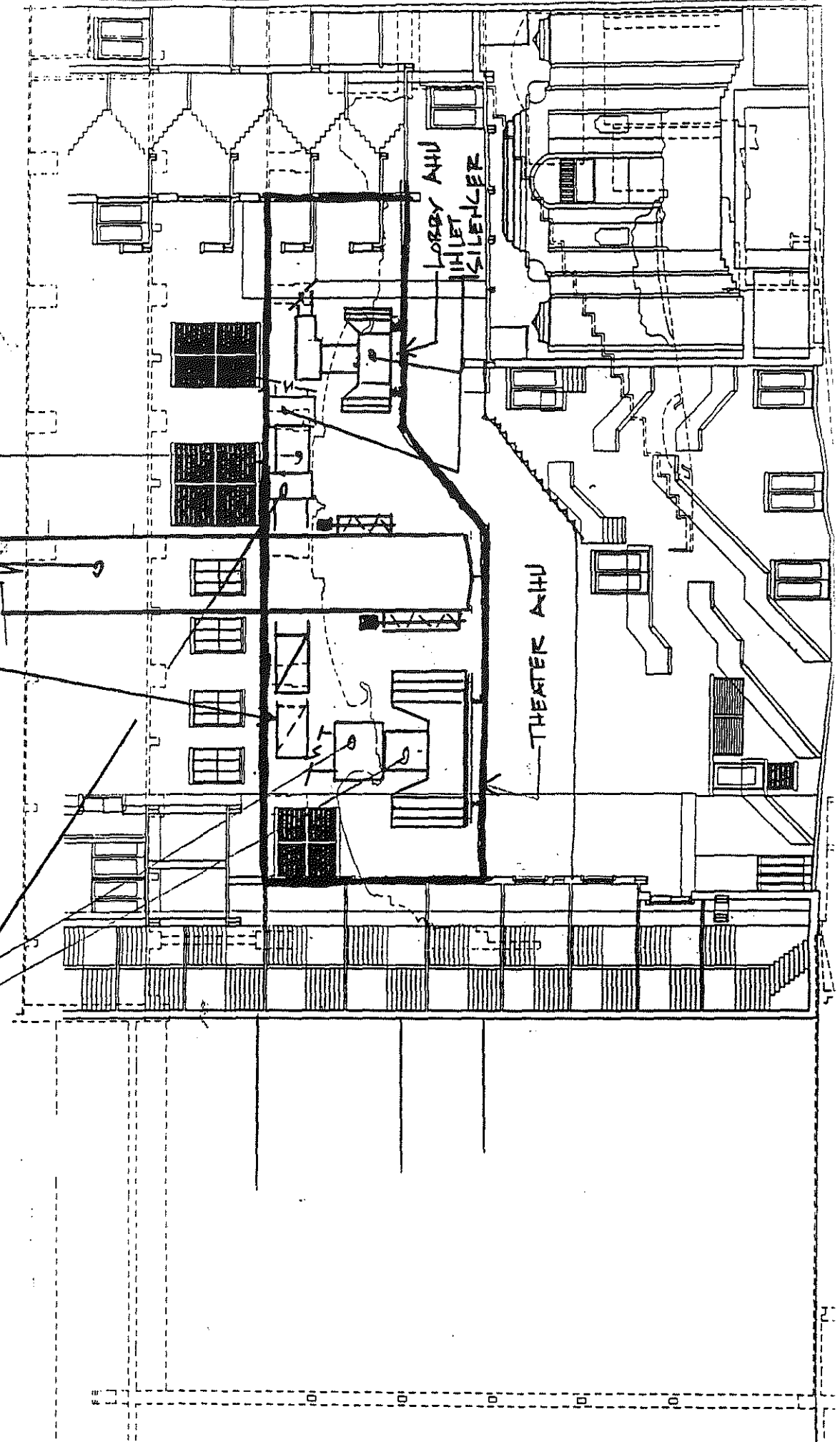

29Mar96 Rev7
 Oriental Theater and Retail Component
 240030 CONSTRUCTION COST ESTIMATE

Note 1

Base Building Construction Costs:				
0070	1.1	General Conditions & Fee	1,800,000	8.89%
	1.2	Scaffolding	250,000	1.39%
	1.3	Demolition / Remediation	700,000	3.89%
	1.4	Excavation and Shoring	250,000	1.39%
	1.5	Underpinning	100,000	0.56%
	1.6	Backfilling	50,000	0.28%
	1.7	Foundation Drainage	5,000	0.03%
	1.8	Formwork	250,000	1.39%
	1.9	Reinforcing Steel	150,000	0.83%
	1.10	Concrete	300,000	1.67%
	1.11	Unit Masonry	500,000	2.78%
	1.12	Structural Steel	850,000	4.72%
	1.13	Steel Roof & Floor Deck	25,000	0.14%
	1.14	Miscellaneous Steel	500,000	2.78%
	1.15	Door / Hardware installation	60,000	0.33%
	1.16	Rough Carpentry	300,000	1.67%
	1.17	Finish Carpentry	400,000	2.22%
	1.18	Insulation, Firestop	75,000	0.42%
	1.19	Roofing	50,000	0.28%
	1.20	Mechanical	2,800,000	15.56%
	1.21	Electrical	2,000,000	11.11%
	1.22	Glass/Aluminum	25,000	0.14%
	1.23	Canopies and Marquees	200,000	1.11%
	1.24	Elevators and Lifts	200,000	1.11%
	1.25	Dock Leveller	18,000	0.10%
	1.26	OH Doors	20,000	0.11%
	1.27	Hollow Metal Doors & Frames	75,000	0.42%
	1.28	STC Rated Doors	50,000	0.28%
	1.29	Finish Hardware	150,000	0.83%
	1.30	Plaster, Drywall & ACT	500,000	2.78%
	1.31	Standard Painting, Coatings & Wallcovering	200,000	1.11%
	1.32	Decorative Painting	1,000,000	5.56%
	1.33	Stretchwall & Acoustic Panels	50,000	0.28%
	1.34	Marble, Terrazzo and Ceramic	300,000	1.67%
	1.35	Resilient Floor and Rubber Base	60,000	0.33%
	1.37	Washroom Accessories	85,000	0.47%
	1.38	& Toilet Partitions	w/ finish carp	0.00%
	1.39	Architectural Louvers	10,000	0.06%
	1.40	Architectural Metals	150,000	0.83%
	1.41	Landscaping & Site Finishes	100,000	0.56%
	1.42	Miscellaneous Glass & Mirrors	70,000	0.39%
	1.45	Beverage Line Conduits	25,000	0.14%
	1.47	Other	32,000	0.18%
		Retail		
	1.50	Store Fronts	225,000	1.25%
	1.51	Interior Finishes	\$10.00 per s.f. 100,000	0.56%
	1.52	Fittings & Equipment	\$5.00 per s.f. 50,000	0.28%
	1.53	Electrical	\$15.00 per s.f. 150,000	0.83%
	1.54	Mechanical	\$20.00 per s.f. 200,000	1.11%
		Total Construction		\$16,260,000 84.78%

240040	Theatre Specialties			
0010	2.1 Theatre Lighting Equipment	300,000		1.67%
0010	2.2 Theatre Sound	100,000		0.56%
0030	2.3 Theatrical Rigging	900,000		5.00%
0040	2.4 Theatre Drapes	100,000		0.56%
0060	2.5 FOH Drapes	150,000		0.83%
	Total Theatre Specialties		\$1,550,000	8.61%

240050	Furniture, Fixtures & Equipment			
0010	3.1 Carpet Supply	250,000		1.36%
0010	3.2 Interior Signage	20,000		0.11%
0030	3.3 Exterior Signage	180,000		1.00%
0040	3.4 Security	50,000		0.28%
0050	3.5 Theatre Seating (Fixed & Loose)	500,000		2.78%
0080	3.6 Bar Equipment	150,000		0.83%
0080	3.7 VIP Furniture	40,000		0.22%
0110	3.8 Lockers	incl		0.00%
	3.9 Miscellaneous	0		0.00%
	Total FF&E		\$1,190,000	6.61%

TOTAL CONSTRUCTION COSTS **\$18,000,000 100.00%**

Contingency:

Construction Contingency	\$1,472,171		
Total Contingency		\$1,472,171	8.18%

TOTAL CONSTRUCTION COSTS INCLUDING CONTINGENCY **\$19,472,171**

Note 1: Costs as a percentage of Total Construction Costs excluding contingency.

29Mar98 Rev7

SOFT COST ESTIMATE (Theater and Retail)

SOFT COSTS 1 (Partial)

Base Building Consultants

Architect - DPCA

750,000

Architect - KEL

475,000

Specification Writer

0

Sub-total Arch. Only

6.8% of hard costs

\$1,225,000

Structural

110,000

Mechanical and base Electrical

280,000

Specialty Electrical

60,000

Sub-total - Base Bldg Consult.

2.4% of hard costs

\$450,000

Specialty Consultants

Historical Consultant

25,000

Theatre Consultant

40,000

Theatrical Lighting

35,000

Theatrical Sound

35,000

Acoustics

40,000

Code (majority w/ arch.)

20,000

Arch. Lighting

25,000

Quantity Surveyor

50,000

Signage

35,000

Bar Design

10,000

Detailed Model

0

Interior Design

20,000

Other

3,796

Sub-total - Spec. Consult.

1.9% of hard costs

\$338,796

Total Design Consultants

11.1% of hard costs

\$1,993,796

On Site Consultants

Geotechnical

25,000

Environmental Testing

85,000

Traffic

0

Survey

35,000

Testing

55,000

Total - On-Site Consult.

1.1% of hard costs

\$200,000

Development Consultant

1.2% of hard costs

\$215,000

TOTAL SOFT COSTS 1 (Partial)

13.4% of hard costs

\$2,408,796

SOFT COSTS 2A

Legal

2.3% of hard costs

\$3.75

\$410,000

Property Taxes during Constr

\$1.10

\$120,000

TOTAL SOFT COSTS 2A

2.9% of hard costs

\$4.85

\$830,000

file:123r4\projects\chgbudget\char7.wk4
29Mar98 Rev7

Combined Oriental Theater & Retail
The 32 West Randolph Building
Project 84 - 368
Preliminary Cost Analysis

SUMMARY STATISTICS

Address	32 West Randolph, Chicago
Gross Theater Floor Area	100,000 sf (estimated)
Gross Retail Floor Area	9,255 sf (estimated)
Total Gross Floor Area	109,255 sf (estimated)
Projected Number of Theatre Seats	2,180 ea

ANALYSIS		(all figures in 1996 US\$)		
Cost Code		Area or %	Cost / sf	Cost
Cost of Land:				
	Oriental Theatre			\$2,000,000
	Retail Component			\$1,800,000
	Oliver Building			TBD
	Total Property Cost			\$3,800,000
Construction Costs:				
240030	Construction	109,255 sf GFA	\$139.87	\$15,280,000
240040	Theatre Specialties		\$14.19	\$1,550,000
240050	Furniture, Fixtures & Equipment		\$10.89	\$1,190,000
	Total Hard Costs	109,255 sf GFA	\$164.75	\$18,020,000
240020 Soft Costs 1:				
	Design Consultants	11.1% of hard costs	\$18.25	\$1,993,796
	Site Consultants	1.1% of hard costs	\$1.83	\$200,000
	Development Consultant	1.2% of hard costs	\$1.87	\$215,000
	Project Management	4.8% of hard costs	\$7.89	\$861,696
	City Fees & Levies		\$0.69	\$75,000
	Utility Connection Fees		\$0.92	\$100,000
	Building Permits	1.0% of hard costs	\$1.58	\$172,380
	Total Soft Costs 1	20.1% of hard costs	\$33.12	\$3,618,073
240025 Soft Costs 2A:				
	Legal	2.3% of hard costs	\$3.75	\$410,000
	Property Taxes during Constr		\$1.10	\$120,000
	Total Soft Costs 2A	2.9% of hard costs	\$4.85	\$430,000
	Total Hard & Soft Costs		\$202.72	\$22,148,073
TOTAL COSTS (excluding contingencies and carrying costs)			\$202.72	\$22,148,073
Carrying Costs & Contingency: (suggested but not carried in Total Costs above)				
	Carrying Costs (Note 1)		\$9.88	\$1,079,756
	Construction Contingency	8.2% of hard costs	\$13.47	\$1,472,171
	Sub Total Carrying & Contingency		\$23.36	\$2,551,927
TOTAL COSTS (Incl. contingencies but excl. Oliver Bldg.)			\$280.88	\$28,800,000
Note 1 Carrying costs on Livant funding only.				

6. Rights of Commonwealth Edison Company with respect to facilities disclosed by its letter dated August 27, 1985, and shown on its conduit and cable map 386-D2A.
7. Encroachment of the building located mainly on the land onto the property east and adjoining by 0.12 of a foot, as disclosed by survey dated November 13, 1986, made by Chicago Guarantee Survey Company, Order #8611019.
8. Encroachment of the building located mainly on the land onto the property east and adjoining by 0.03 of a foot, as disclosed by survey dated November 13, 1986, made by Chicago Guarantee Survey Company, Order #8611019.
9. Encroachment of the stone base of the building located mainly on the land, which extends 1.65 feet west and 0.66 of a foot south from the south west corner of the land, as disclosed by survey dated November 13, 1986, made by Chicago Guarantee Survey Company, Order #8611019.
10. Encroachment of the building located mainly onto the public way north and adjoining by 0.89 of a foot, as disclosed by survey dated November 13, 1986, made by Chicago Guarantee Survey Company, Order #8611019.
11. Encroachment of the building located mainly on the land onto the public way west and adjoining by 1.15 feet, as disclosed by survey dated November 13, 1986, made by Chicago Guarantee Survey Company, Order #8611019.
12. Encroachment of a metal vent of the building located on the land, onto the public way north and adjoining, by approximately 2.00 feet, as disclosed by survey dated November 13, 1986, made by Chicago Guarantee Survey Company, Order #8611019.
13. Encroachment of a sign on the building located on the land, onto the public way west and adjoining, by 15.15 feet, as disclosed by survey dated November 13, 1986, made by Chicago Guarantee Survey Company, Order #8611019.
14. Encroachment of the canopy attached to the building located on the land, onto the public way west and adjoining, by 15.65 feet, as disclosed by survey dated November 13, 1986, made by Chicago Guarantee Survey Company, Order #8611019.

THE ORIENTAL THEATER

300 West Riverside
CHICAGO ILLINOIS

Livent (US) Inc.

300 West Riverside
Chicago, Illinois 60607
Project Manager: Paul J. ...

Kofman Engineering Ltd.

300 West Riverside
Chicago, Illinois 60607
Architect

Donald P. Coffey
& Associates, Ltd.

300 West Riverside
Chicago, Illinois 60607
Structural Engineer

TITLE SHEET
ORIENTAL THEATER

Scale: _____
Date: March 28, 1988
Project Number: 8507
Drawing Number: TTT-1001-000

A0-1

LIST OF DRAWINGS

- ARCHITECTURAL
- A0-1 TITLE SHEET
- A1-1 THIRD BASEMENT
- A1-2 SECOND BASEMENT
- A1-3 FIRST BASEMENT
- A1-4 ORCHESTRA FLOOR
- A1-5 DRESS CIRCLE FLOOR
- A1-6 LOWER BALCONY FLOOR
- A1-7 MIDDLE BALCONY FLOOR
- A1-8 UPPER BALCONY FLOOR
- A1-9 CAT WALK FLOOR/SIXTH FLOOR
- A1-10 SEVENTH FLOOR & GRID
- A1-11 EIGHTH FLOOR & GRID
- A1-12 NINTH FLOOR & ROOF
- A3-1 LONGITUDINAL SECTION
- A4-1 RANDOLPH ELEVATION
- A4-2 COLUZH PLACE ELEVATION
- A4-3 OLIVER BUILDING ELEVATION

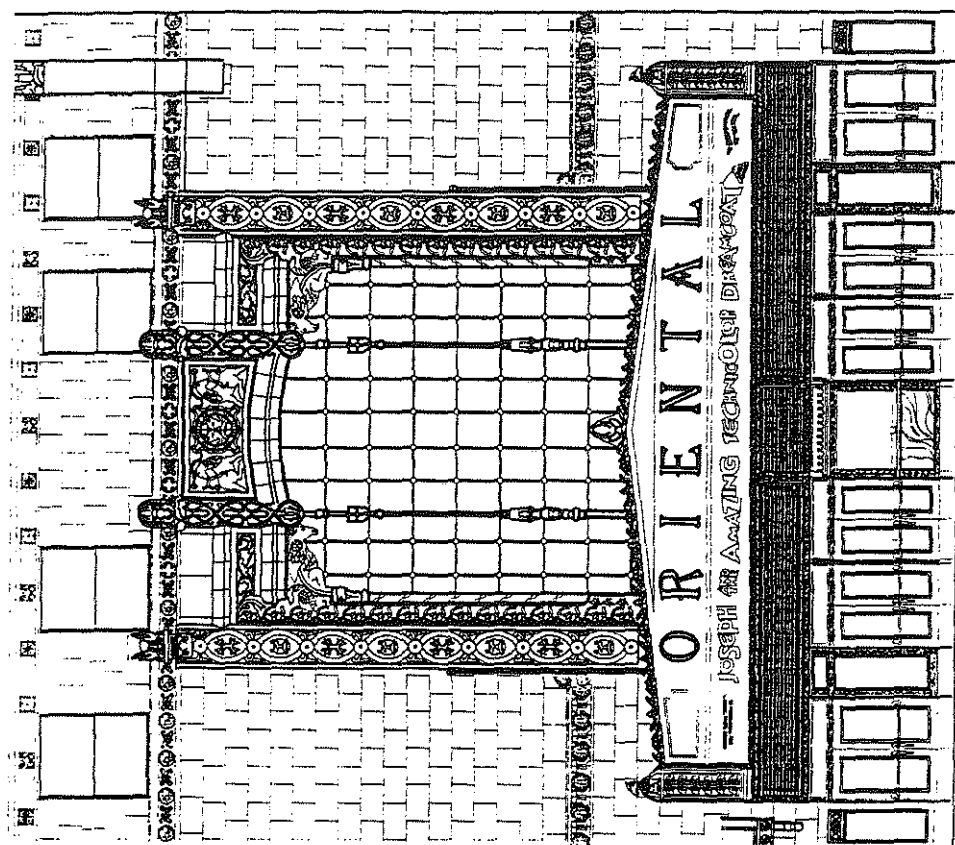

Exhibit D



ORIENTAL

PAUL ASH

1-6947

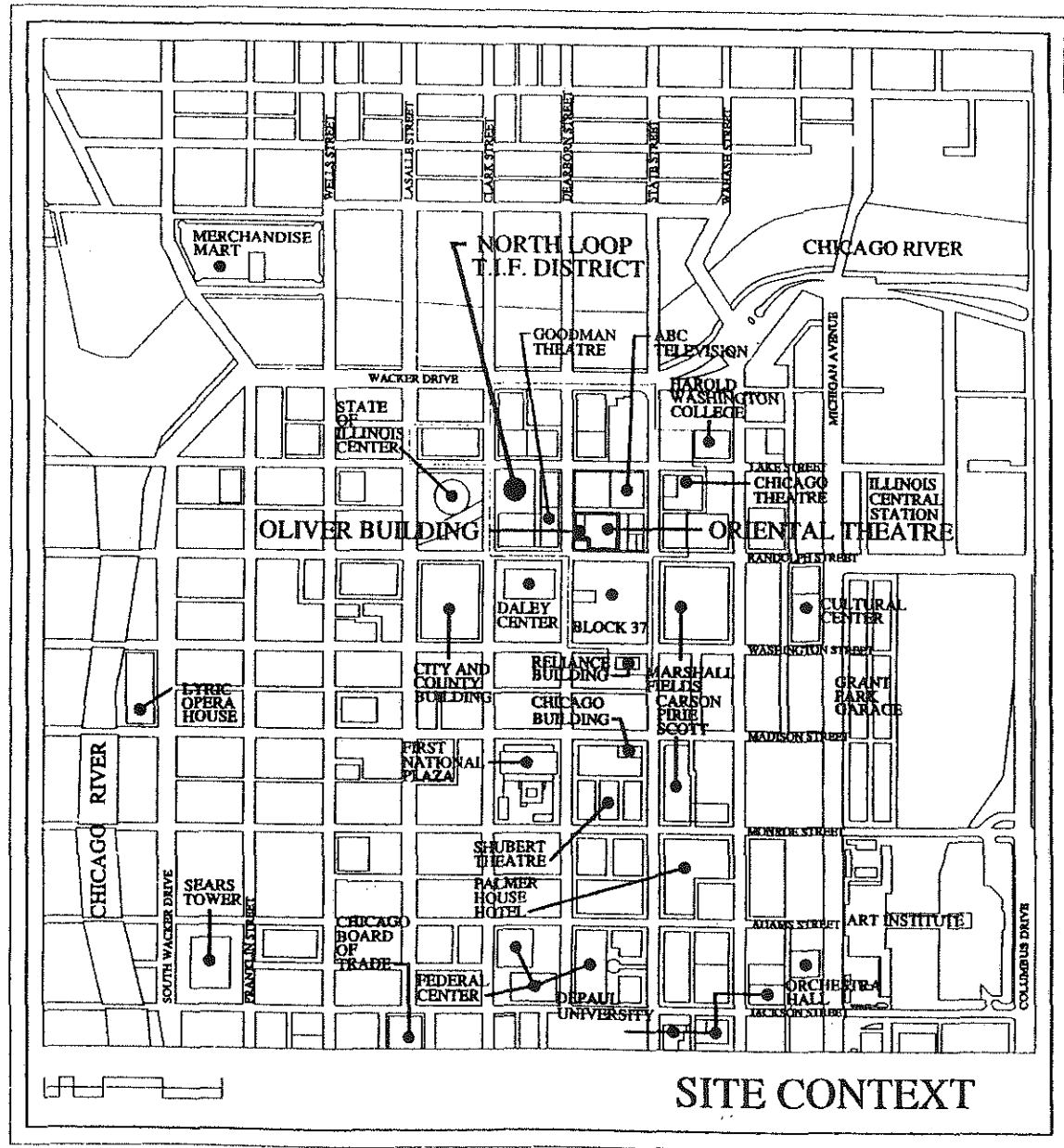

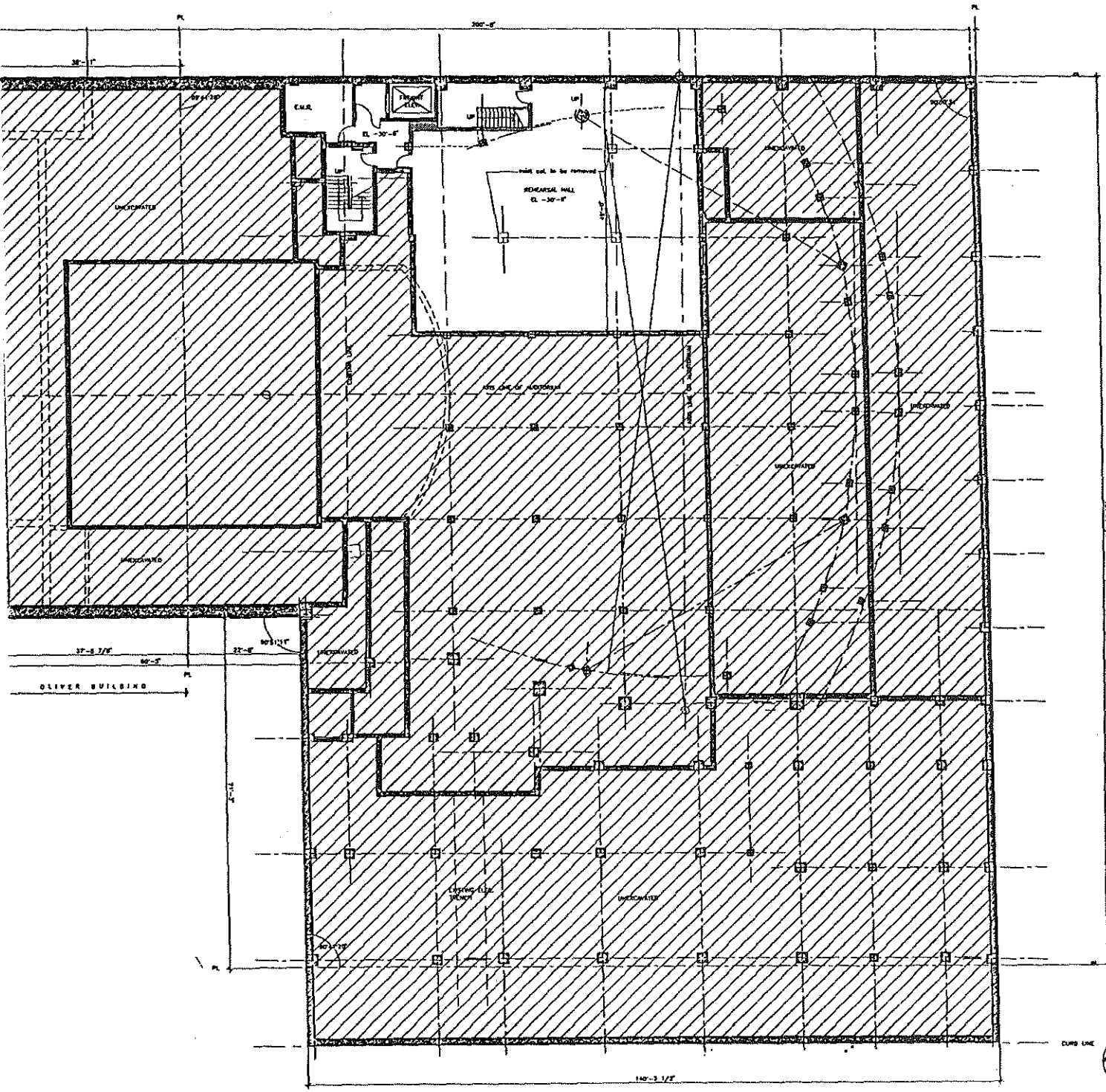

Project:

Oriental Theater Redevelopment

24 West Randolph
Chicago, Illinois

Owner:

Livent (U.S.) Inc.

Suite 600
165 Avenue Road
Toronto, Ontario M5R 2H7

Project Manager:

Kofman Engineering, Ltd.

Suite 501
165 Avenue Road
Toronto, Ontario M5R 3S4
(416) 925 - 7183

Architect:

Daniel P. Coffey & Associates, Ltd.

Suite 5750
213 South Wacker Drive
Chicago, Illinois 60606
(312) 302 - 9888

Structural Engineer:
Yolles Partnership, Inc.

Suite 200
143 Queen St. East
Toronto, Ontario M5A 1S1

Mechanical/Electrical Engineer:
Environmental System Design, Inc.
Suite 1060
25 East Madison
Chicago, Illinois 60603

Acoustic Engineer:
John Swallow Associates

250 Colony Boulevard
Elmhurst, Ontario M3W 5R8
Engineer:

No.	REVISION	DATE

Drawing Title:
Basement Plan 3
(el. -30'-6")

0' 2' 4' 8' 16'
Scale: 1/16" = 1'-0"
Date: 28 March 1998
Project Number: 9507
Drawing Name: MEC519.DWG



A1-1

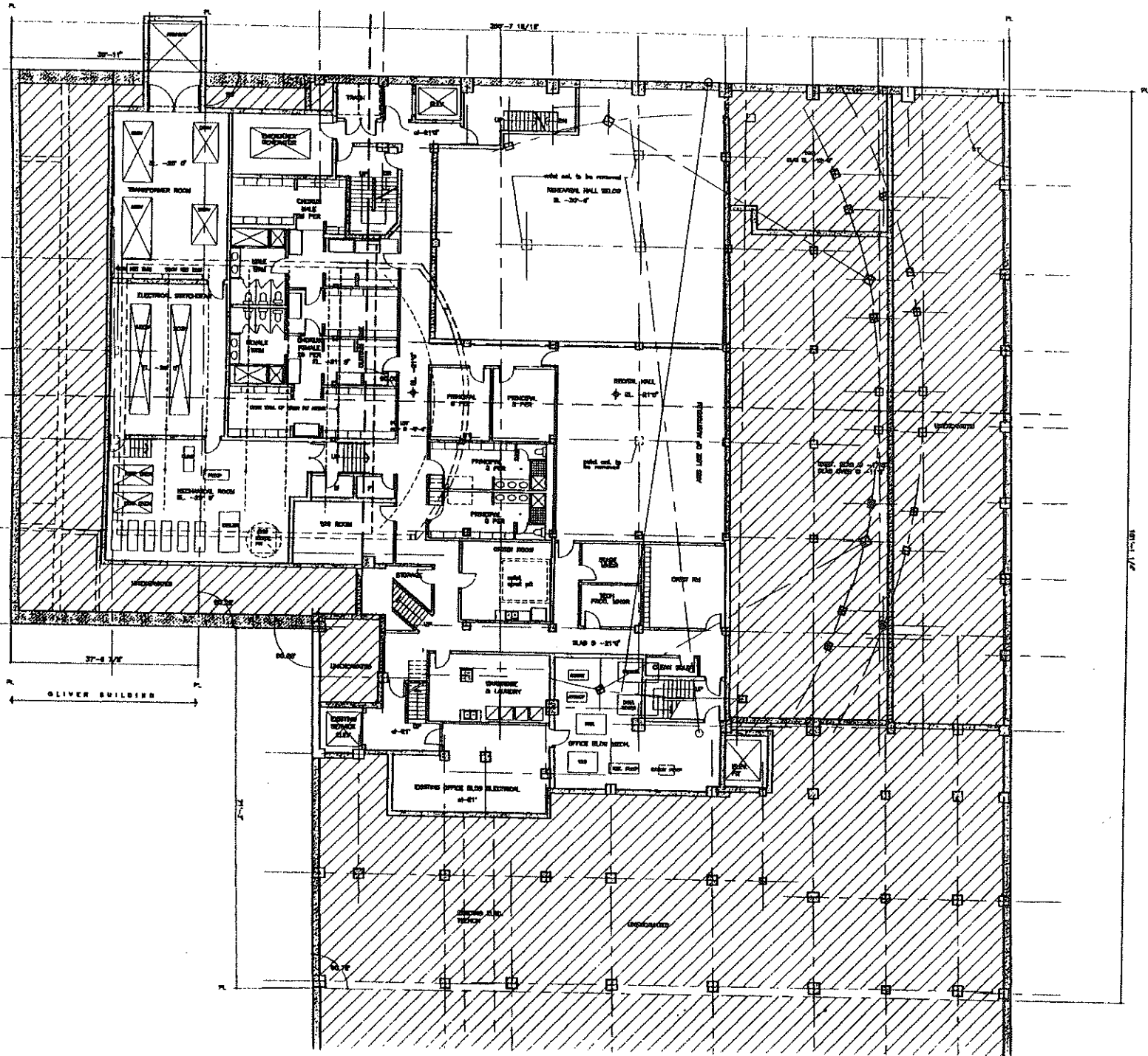

Project:

Oriental Theater Redevelopment

24 West Randolph
Chicago, Illinois

Owner:

Livent (U.S.) Inc.

Suite 800
185 Avenue Road
Toronto, Ontario M5R 2A7

Project Manager:

Kofman Engineering, Ltd.

Suite 501
185 Avenue Road
Toronto, Ontario M5R 2S4
(416) 925 - 7183

Architect:

Daniel P. Coffey & Associates, Ltd.

Suite 8750
233 South Wacker Drive
Chicago, Illinois 60608
(312) 362 - 8888

Structural Engineer:

Yolles Partnership, Inc.

Suite 208
183 Queen St. East
Toronto, Ontario M5A 1S1

Mechanical/Electrical Engineer:

Environmental System Design, Inc.

Suite 1800
85 East Wacker
Chicago, Illinois 60603

Accounting Engineer:

John Swallow Associates

350 Galaxy Boulevard
Burlington, Ontario M7R 5Y8

Engineer:

No. REVISION DATE
Drawing Title

Basement Plan 2
(el. -21'-0")

Scale: 1/8" = 1'-0"

Project

Oriental Theater Redevelopment

24 West Randolph
Chicago, Illinois

Owner:

Livent (U.S.) Inc.

Suite 600
185 Avenue Road
Toronto, Ontario M5R 2A7

Project Manager:

Kolman Engineering, Ltd.

Suite 501
185 Avenue Road
Toronto, Ontario M5R 2A7
(416) 928-7183

Architect:

Daniel P. Coffey
& Associates, Ltd.

Suite 5750
233 South Wacker Drive
Chicago, Illinois 60604
(312) 382-8988

Structural Engineer:

Yolles Partnership, Inc.

Suite 200
450 East
Chicago, Illinois 60611
Tel. 312-467-1511

Mechanical/Electrical Engineer:

Environmental System Design, Inc.

Suite 1608
285 East
Chicago, Illinois 60603

Acoustical Engineer:

John Swallow
Associates

169 Cedar Boulevard
Evanston, Illinois 60201
Tel. 708-477-5498

No. REVISION DATE

Drawing Title:

Basement Plan I (el. -12'-0")

Scale: 1/16" = 1'-0"
Date: 28 March 1998
Project Number: 9507
Drawing Name: TRUCKDRIVE

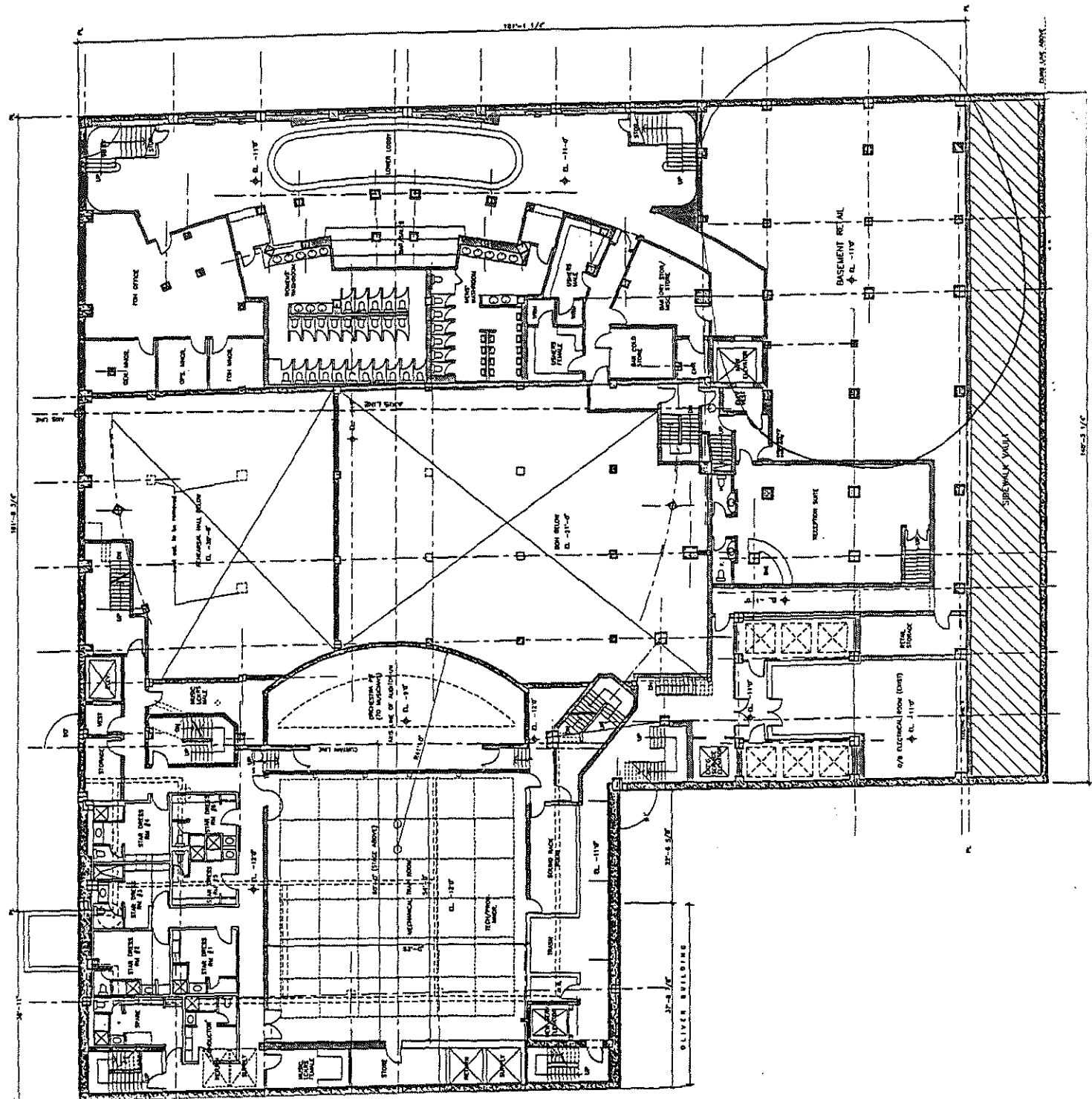

NS-3-1/C

DRIVE WAY ADJACENT

SUBWAY VAULT

OLIVER BUILDING

31'-0 3/4"

32'-4 1/2"

32'-0 1/2"

32'-8 1/2"

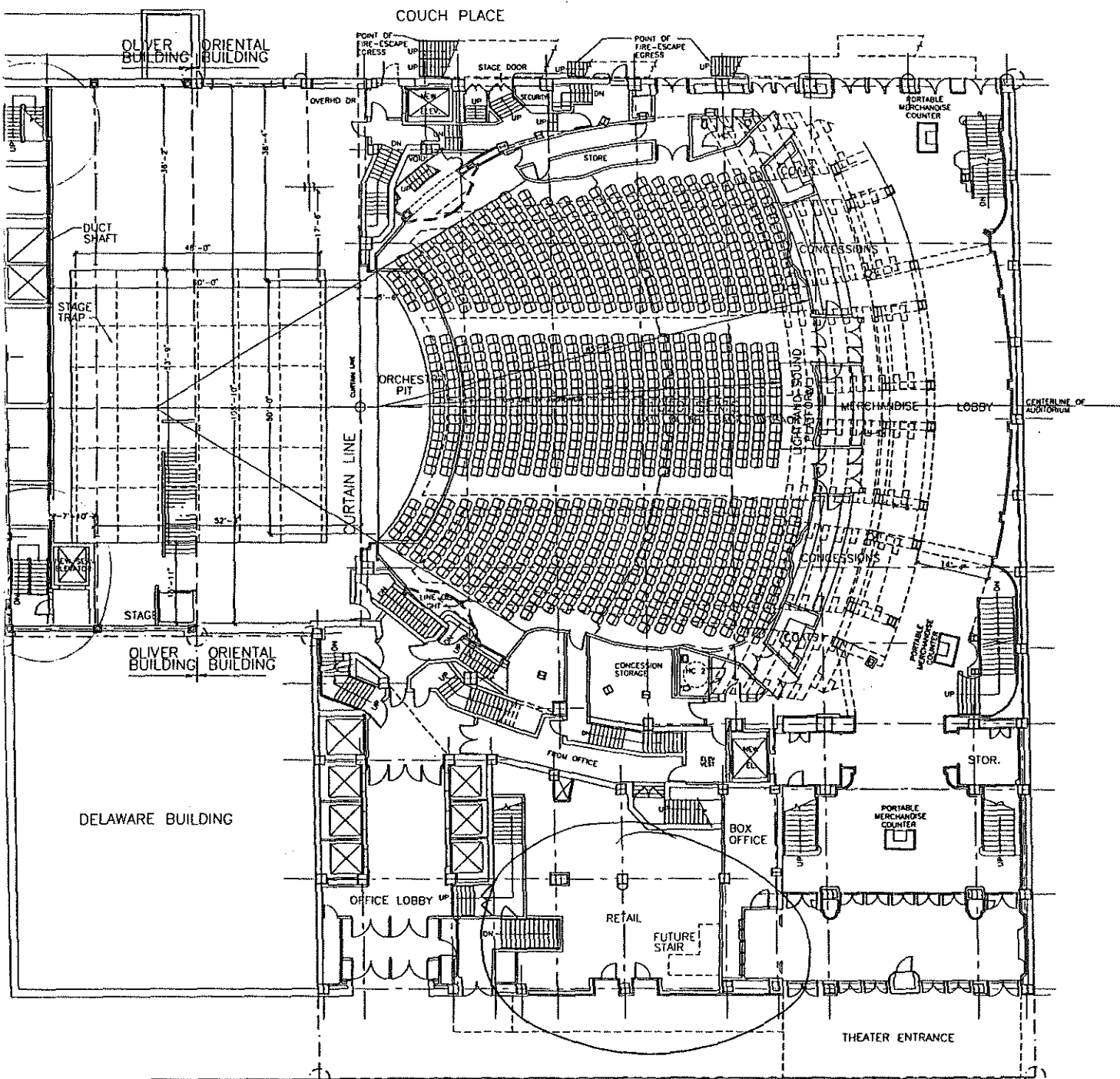

Project:

Oriental Theater Redevelopment

24 West Randolph
Chicago, Illinois

Owner:

Livent (U.S.) Inc.

Suite 800
165 Avenue Road
Toronto, Ontario M5R 2H7

Project Manager:

Kofman Engineering, Ltd.

Suite 501
165 Avenue Road
Toronto, Ontario M5R 3S4
(416) 925 - 7183

Architect:

Daniel P. Coffey
& Associates, Ltd.

Suite 5750

233 South Wacker Drive
Chicago, Illinois 60606
(312) 382 - 8898

Structural Engineer:

Yolles Partnership, Inc.

Suite 200

163 Queen St. East
Toronto, Ontario M5A 1S1

Mechanical/Electrical Engineer
Environmental
System Design, Inc.

Suite 1859
55 East Monroe
Chicago, Illinois 60603

Acoustical Engineer:

John Swallow
Associates

250 Gateway Boulevard
Elielooka, Ontario M9W 8A8

Engineer:

No. REVISION DATE

Drawing Title:

**Orchestra Level
(e.l. 0.0)**



Scale:
Date: 28 March 1996
Project Number: 9507
Drawing Name: ORCS9.DWG



A1-4

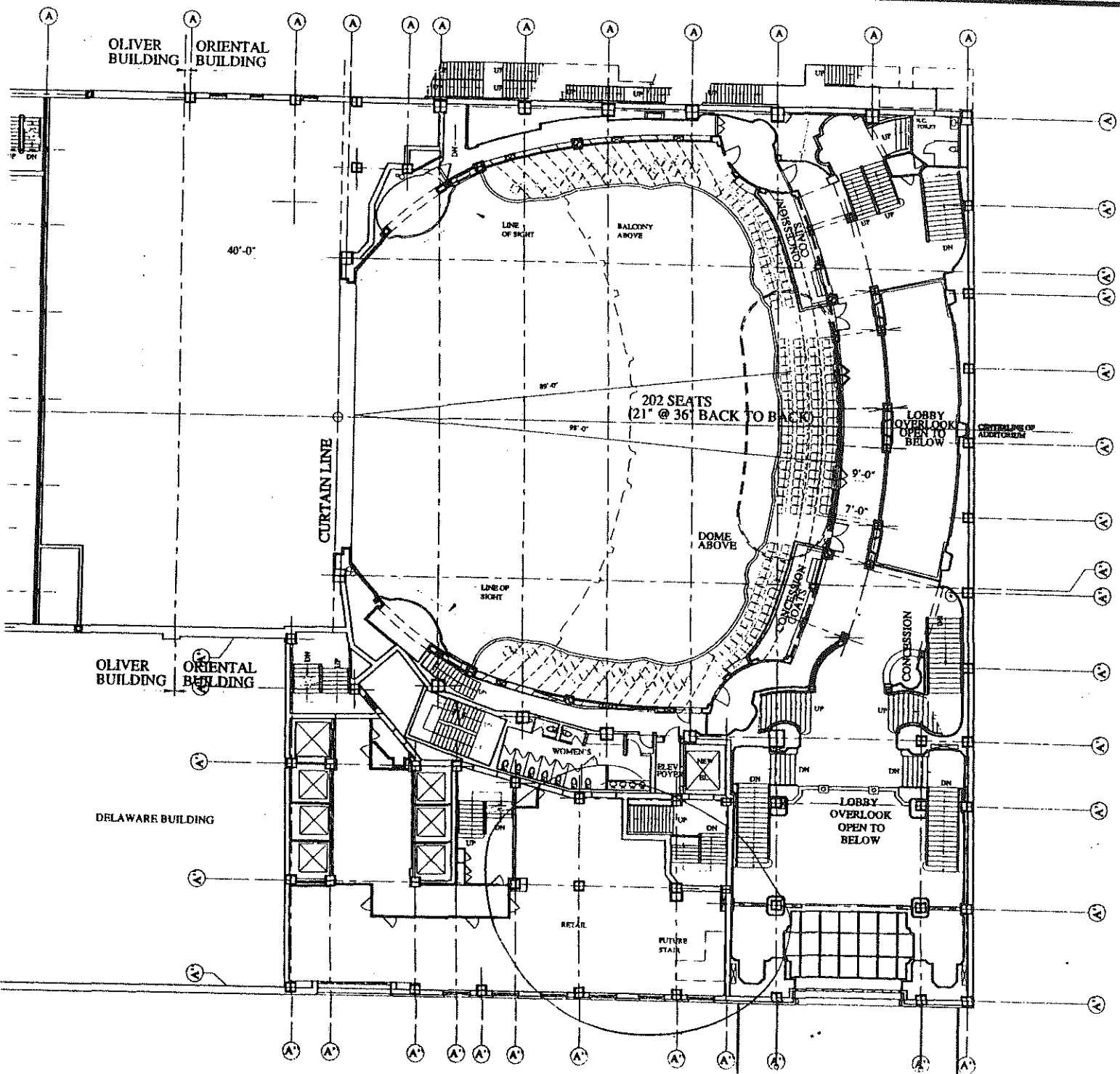

Project:

Oriental Theater Redevelopment

24 West Randolph
Chicago, Illinois

Owner:

Livent (U.S.) Inc.

Sub 600
105 Avenue Road
Toronto, Ontario M5R 2H7

Project Manager:

Kofman Engineering, Ltd.

Sub 201
105 Avenue Road
Toronto, Ontario M5R 2S4
(416) 828 - 7183

Architect:

**Daniel P. Coffey
& Associates, Ltd.**

Sub 5750
233 South Wacker Drive
Chicago, Illinois 60606
(312) 382 - 0000

Structural Engineer:
Yokos Partnership, Inc.

Sub 200
183 Queen St. East
Toronto, Ontario M5A 1S1

Mechanical/Electrical Engineer:
**Environmental
System Design, Inc.**

Sub 1900
55 East Wacker
Chicago, Illinois 60601

Acoustical Engineer:
**John Sealow
Associates**

220 Galaxy Boulevard
Eatonville, Ontario M5W 5R5

Engineer:

No. REVISION DATE
Drawing Title:

**Dress Circle
(el. 13'-6")**

0 2 4 8 16'
Scale: 1/8" = 1'-0"
Date: 28 March 1994

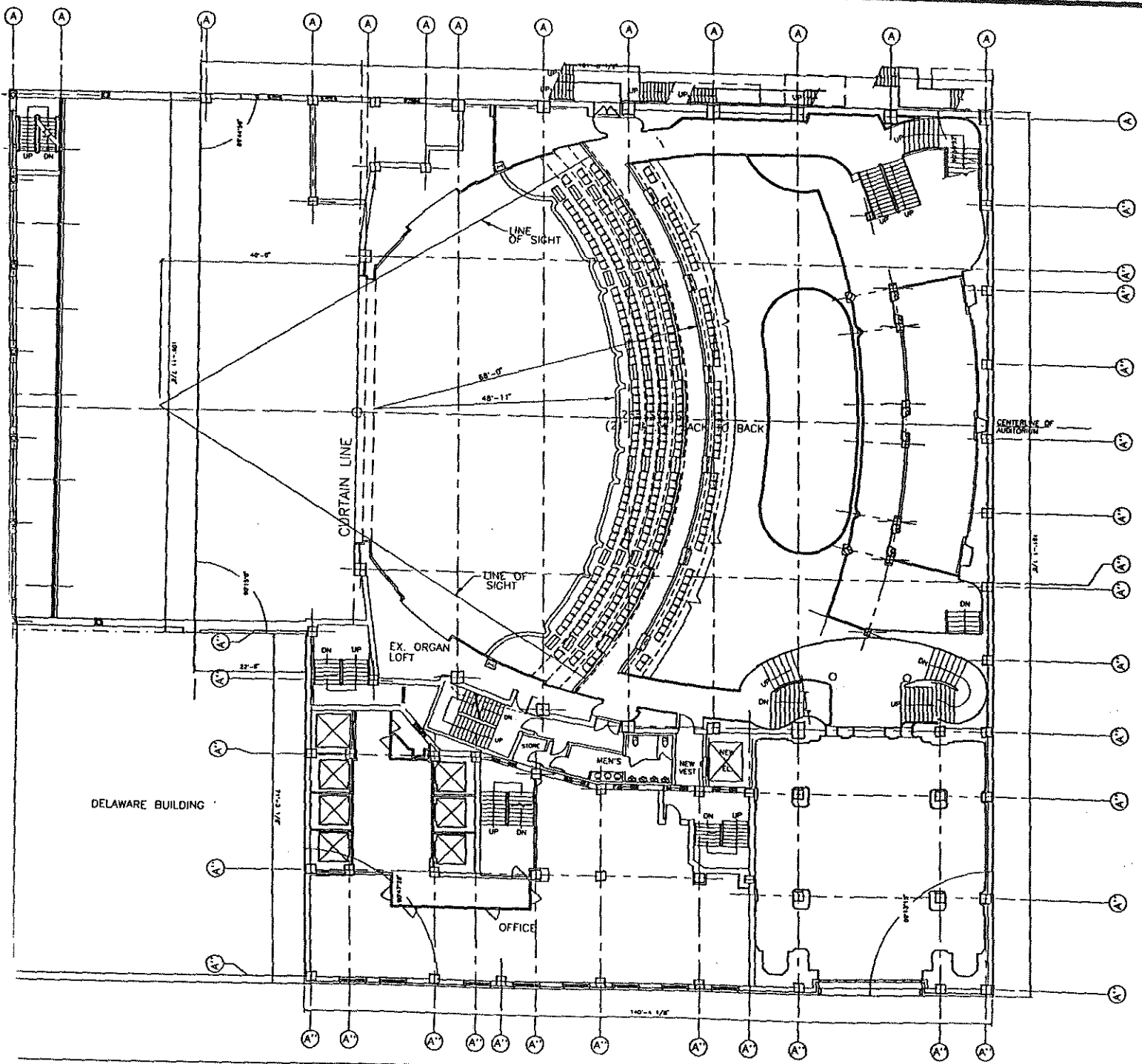

Project:
Oriental Theater
 Redevelopment
 24 West Randolph
 Chicago, Illinois

Owner:
Livent (U.S.) Inc.

Suite 600
 165 Avenue Road
 Toronto, Ontario M5R 2H7

Project Manager:
Kofman Engineering, Ltd.

Suite 501
 185 Avenue Road
 Toronto, Ontario M5R 3S4
 (416) 925-7193

Architect:
Daniel P. Coffey & Associates, Ltd.

Suite 9750
 233 South Wacker Drive
 Chicago, Illinois 60606
 (312) 382-9899

Structural Engineer:
Yolles Partnership, Inc.

Suite 200
 183 Queen St. East
 Toronto, Ontario M5A 1S1

Mechanical/Electrical Engineer:
Environmental System Design, Inc.

Suite 1660
 35 East Wacker
 Chicago, Illinois 60603

Acoustical Engineer:
John Swallow Associates

250 Colony Boulevard
 Etobicoke, Ontario M9W 5R8

Engineer:

No. REVISION DATE

Drawing Title:
Low-Balcony (25'-0")

Scale:
 1/8" = 1'-0"
 Date: 26 March 1999
 Project Number: 9307
 Drawing Name: LOWBALSDWG

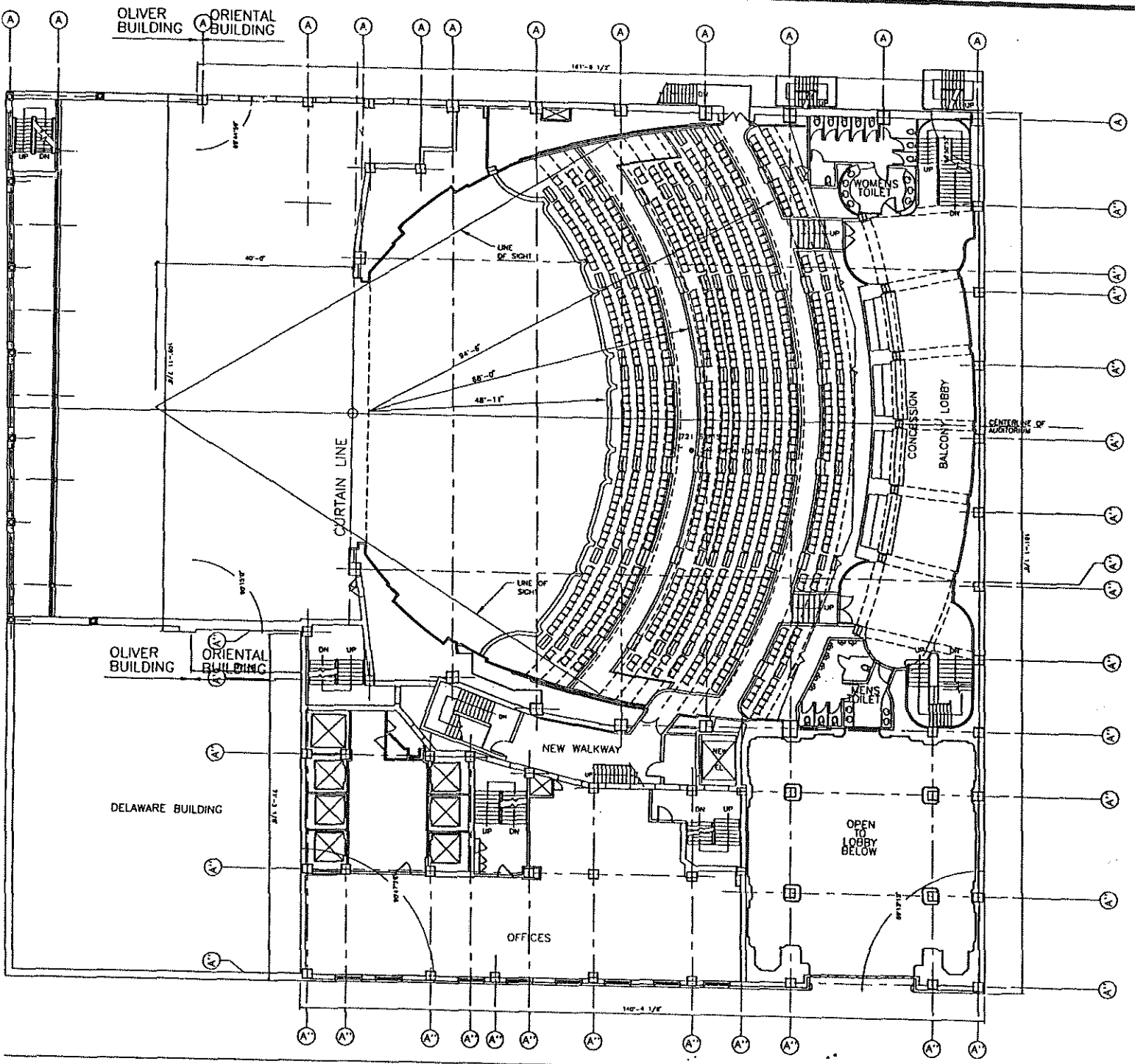

Project:

Oriental Theater Redevelopment

24 West Randolph
Chicago, Illinois

Owner:
Livent (U.S.) Inc.

Suite 600
185 Avenue Road
Toronto, Ontario M5R 2H7

Project Manager:
Kofman Engineering, Ltd.

Suite 501
185 Avenue Road
Toronto, Ontario M5R 3S4
(416) 925 - 7183

Architect:
Daniel P. Coffey & Associates, Ltd.

Suite 5750
233 South Wacker Drive
Chicago, Illinois 60606
(312) 382 - 8898

Structural Engineer:
Volles Partnership, Inc.

Suite 200
183 Queen St. East
Toronto, Ontario M5A 1S1

Mechanical/Electrical Engineer:
Environmental System Design, Inc.
Suite 1850
35 East Monroe
Chicago, Illinois 60603

Acoustical Engineer:
John Swallow Associates

250 Galena Boulevard
Evanston, Illinois 60201
Engineer:

No. REVISION DATE
Drawing Title:

Mid-Balcony (32'-0")

Scale: 1/16" = 1'-0"
Date: 28 March 1988
Project Number: 8507
Drawing Name: MIDBAL10DWG

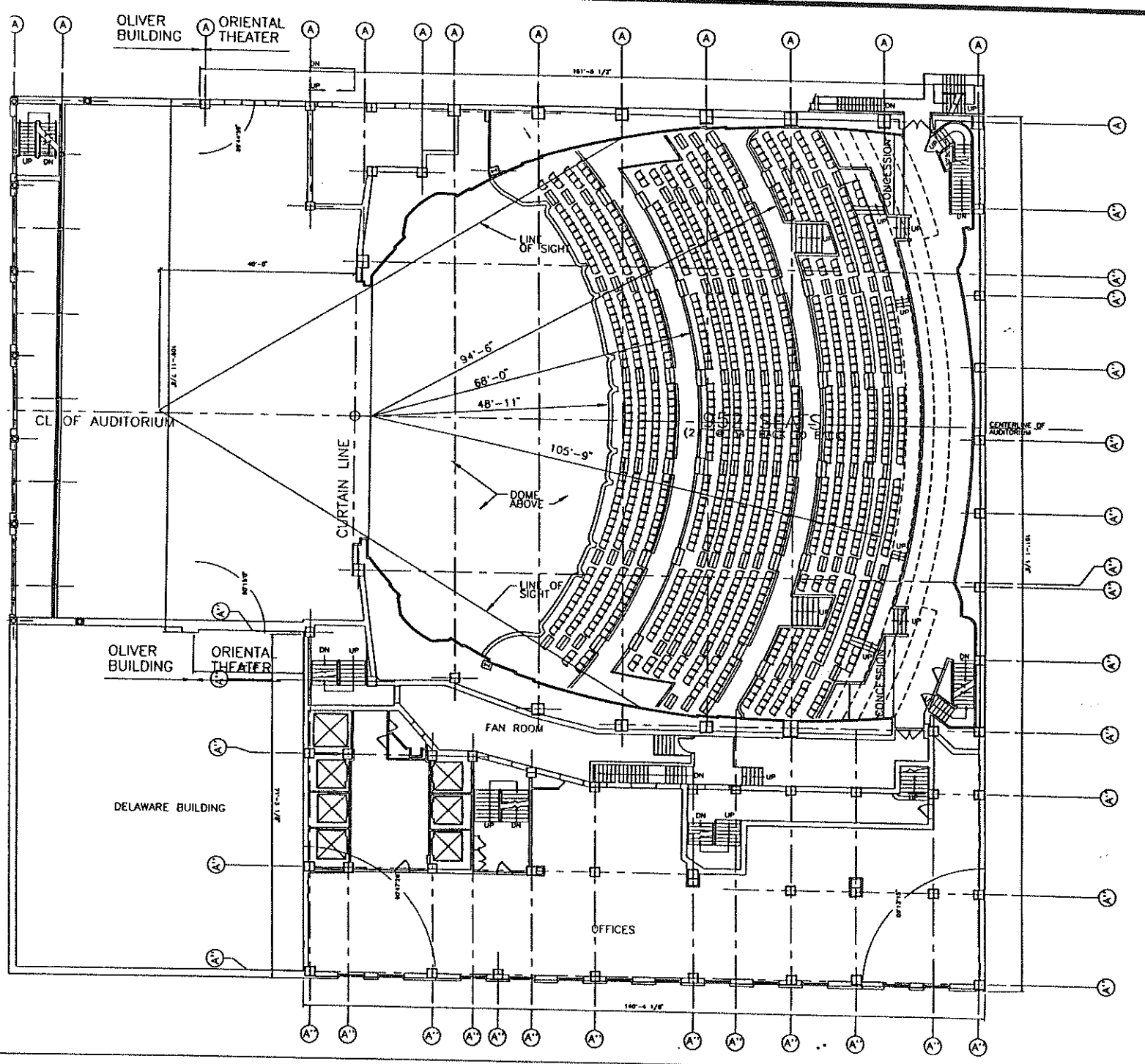

Project:
Oriental Theater Redevelopment
 24 West Randolph
 Chicago, Illinois

Owner:
Livent (U.S.) Inc.
 Suite 600
 185 Avenue Road
 Toronto, Ontario MSR 2H7

Project Manager:
 Kolman Engineering, Ltd.
 Suite 501
 185 Avenue Road
 Toronto, Ontario MSR 354
 (416) 925 - 7183

Architect:
Daniel P. Coffey & Associates, Ltd.
 Suite 5730
 233 South Wacker Drive
 Chicago, Illinois 60608
 (312) 382 - 9888

Structural Engineer:
 Yolles Partnership, Inc.
 Suite 209
 183 Queen St. East
 Toronto, Ontario M5A 1S1

Mechanical/Electrical Engineer:
Environmental System Design, Inc.
 Suite 1860
 53 East Monroe
 Chicago, Illinois 60603

Acoustical Engineer:
John Swallow Associates
 250 Canary Boulevard
 Etobicoke, Ontario MSW 5R8

Engineer:

No.	REVISION	DATE

Drawing Title:
Upper Balcony (45'-7')

Scale: 1/16" = 1'-0"
Date: 28 March 1956
Project Number: 9507
Drawing Name: UPPBAL16.DWG



Project:

Oriental Theater Redevelopment

24 West Randolph
Chicago, Illinois

Owner:

Livent (U.S.) Inc.

Suite 800
185 Avenue Road
Toronto, Ontario M5R 2H7

Project Manager:

Kofman Engineering, Ltd.

Suite 501
185 Avenue Road
Toronto, Ontario M5R 3S4
(416) 925 - 7183

Architect:

Daniel P. Coffey
& Associates, Ltd.

Suite 5750
233 South Wacker Drive
Chicago, Illinois 60608
(312) 382 - 8898

Structural Engineer:

Yolles Partnership, Inc.

Suite 200
183 Queen St. East
Toronto, Ontario M5A 1S1

Mechanical/Electrical Engineer:

Environmental
System Design, Inc.

Suite 1660
53 East Wacker
Chicago, Illinois 60603

Acoustical Engineer:

John Swallow
Associates

250 Galaxy Boulevard
Etobicoke, Ontario M9W 5R8

Engineer: 11

No. REVISION DATE

Drawing Title:

Sixth Floor
Catwalk Floor
(57'-2")

0' 2' 4' 8' 16'

Scale: 1/8"=1'-0"

Date: 28 March 1996

Project Number: 9507

Drawing Name: SIXTH0.DWG

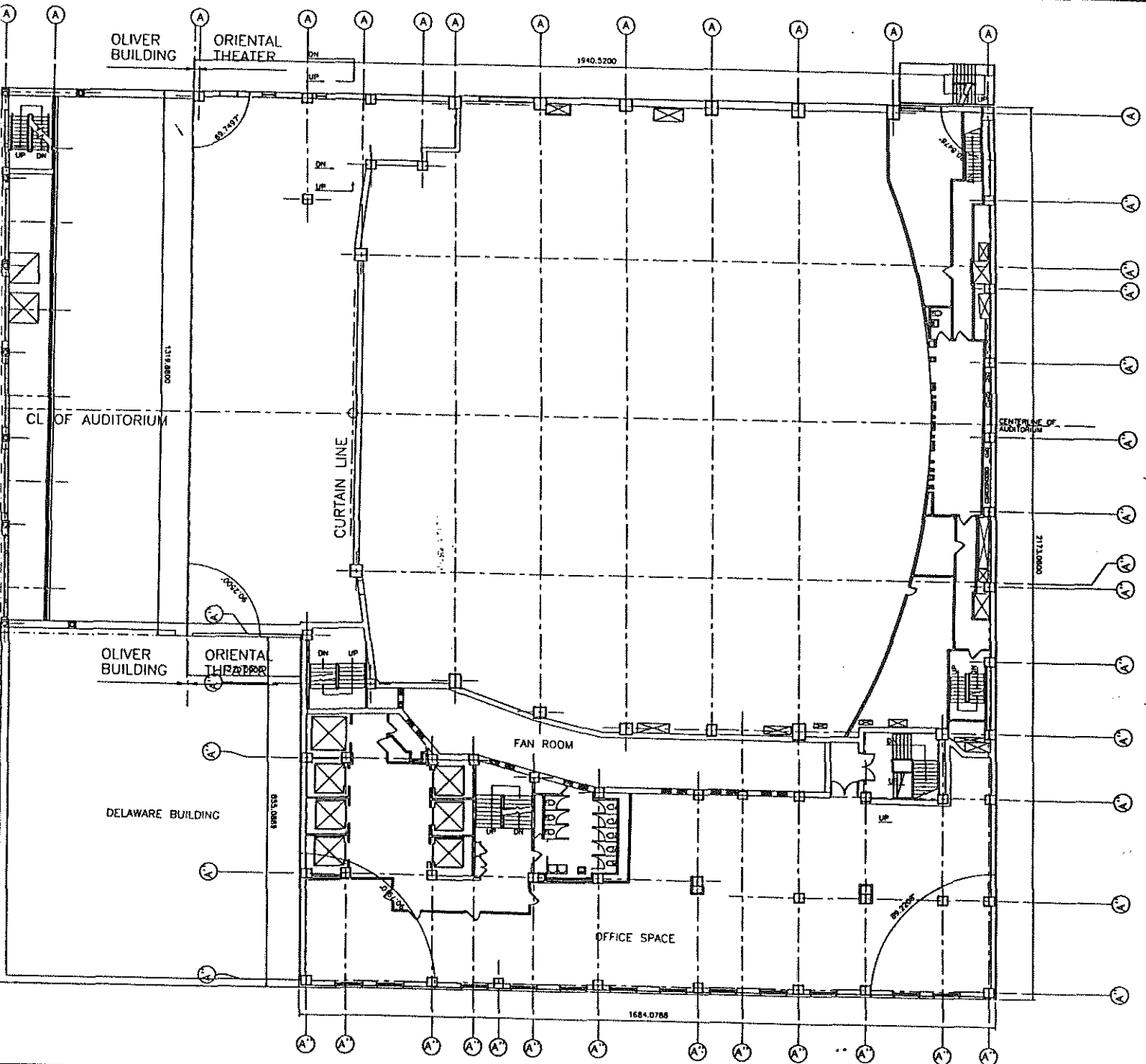

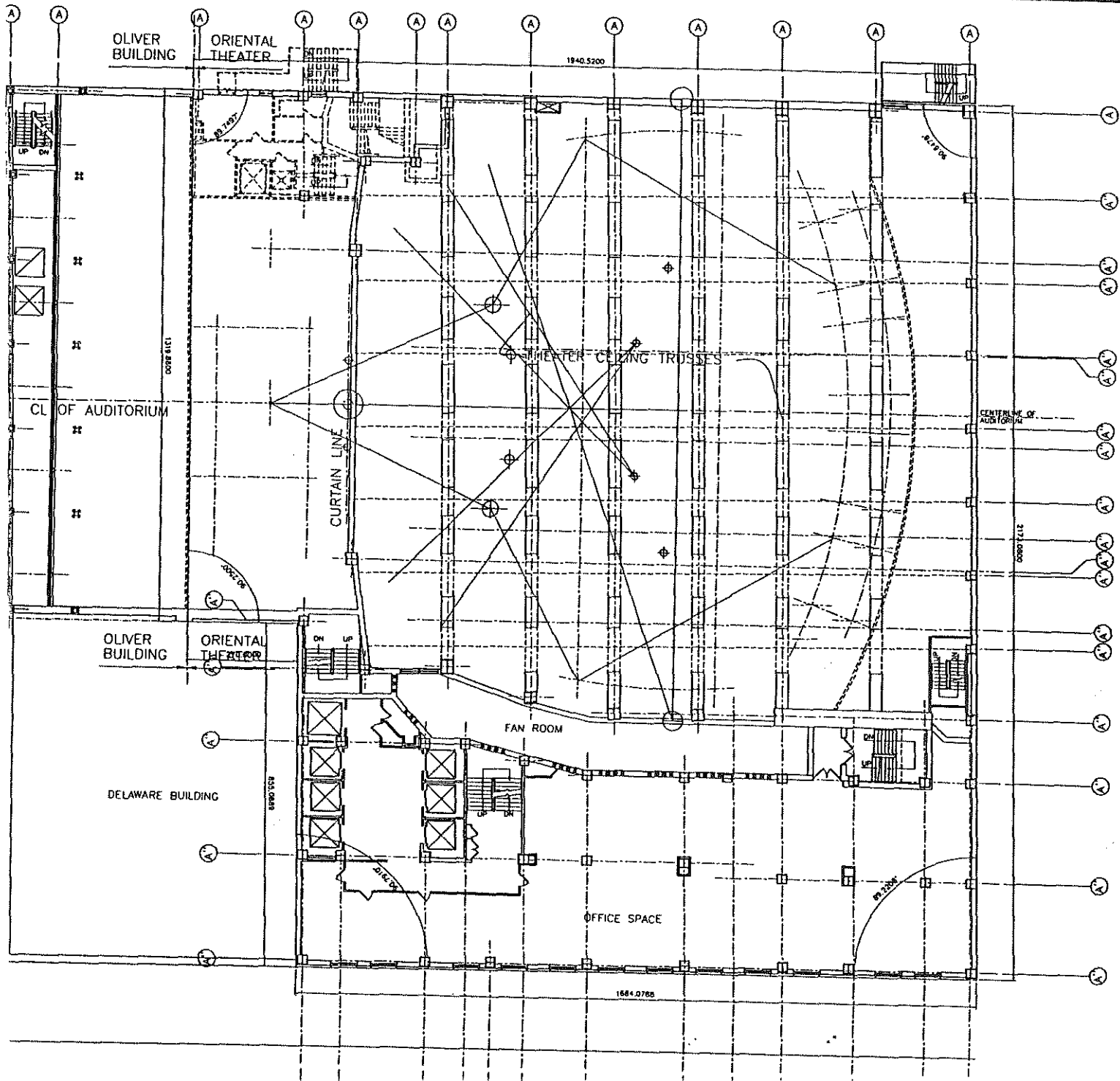

Project:

Oriental Theater Redevelopment

24 West Randolph
Chicago, Illinois

Owner:

Livent (U.S.) Inc.

Suite 800
165 Avenue Road
Toronto, Ontario M5R 2H7

Project Manager:

Kofman Engineering, Ltd.

Suite 501
165 Avenue Road
Toronto, Ontario M5R 3S4
(416) 925 - 7183

Architect:

Daniel P. Coffey & Associates, Ltd.

Suite 5750
233 South Wacker Drive
Chicago, Illinois 60606
(312) 382 - 9898

Structural Engineer:
Yalles Partnership, Inc.

Suite 200
163 Queen St. East
Toronto, Ontario M5A 1S1

Mechanical/Electrical Engineer:
Environmental System Design, Inc.
Suite 1800
55 East Monroe
Chicago, Illinois 60603

Acoustical Engineer:
John Swallow Associates
250 Gateway Boulevard
Etobicoke, Ontario M9W 5R6

Engineer:

No. REVISION DATE

Drawing Title:

Seventh Floor (69'-0")

Scale: 1/8" = 1'-0"

Date: 28 March 1994

Project Number: 9507

Drawing Name: SEVENTH DWG

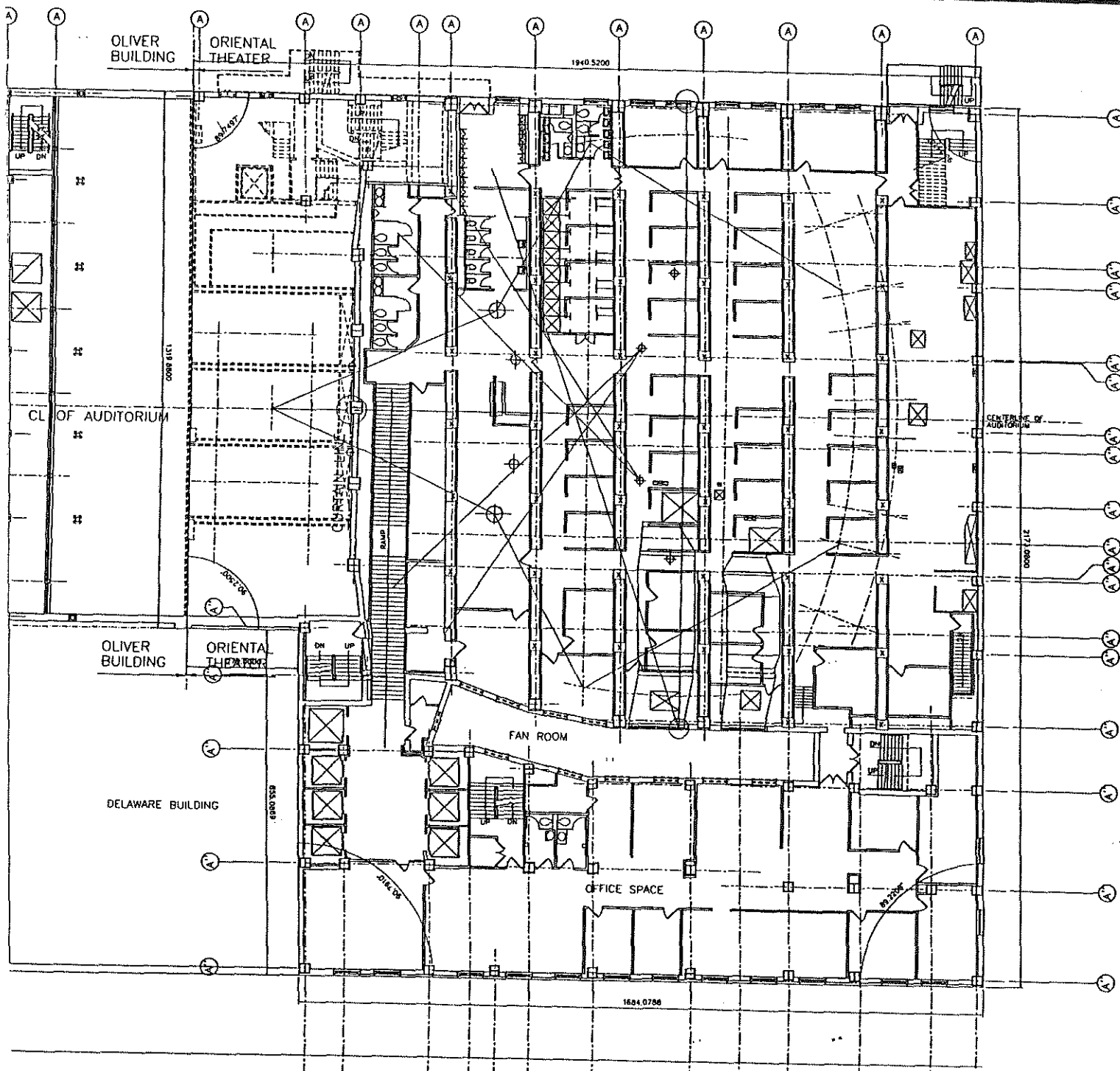

Project:

Oriental Theater Redevelopment

24 West Randolph
Chicago, Illinois

Owner:

Livent (U.S.) Inc.

Suite 600

185 Avenue Road
Toronto, Ontario MSR 2H7

Project Manager:

Kofman Engineering, Ltd.

Suite 501

185 Avenue Road
Toronto, Ontario MSR 3S4
(416) 925 - 7183

Architect:

Daniel P. Coffey
& Associates, Ltd.

Suite 5750

233 South Wacker Drive
Chicago, Illinois 60608
(312) 382 - 9898

Structural Engineer:

Yalles Partnership, Inc.

Suite 200

163 Queen St. East
Toronto, Ontario M5A 1S1

Mechanical/Electrical Engineer:

Environmental
System Design, Inc.

Suite 1600
55 East Monroe
Chicago, Illinois 60603

Acoustical Engineer:

John Swallow
Associates

250 Colony Boulevard
Ettobicoke, Ontario M9W 5R8

Engineer:

No. REVISION DATE

Drawing Title:

8TH FLOOR (80'-0")



Scale: 1/8" = 1'-0"

Date: 28 March 1996

Project Number: 8507

Drawing Name: EIGHTH FLOOR DWG

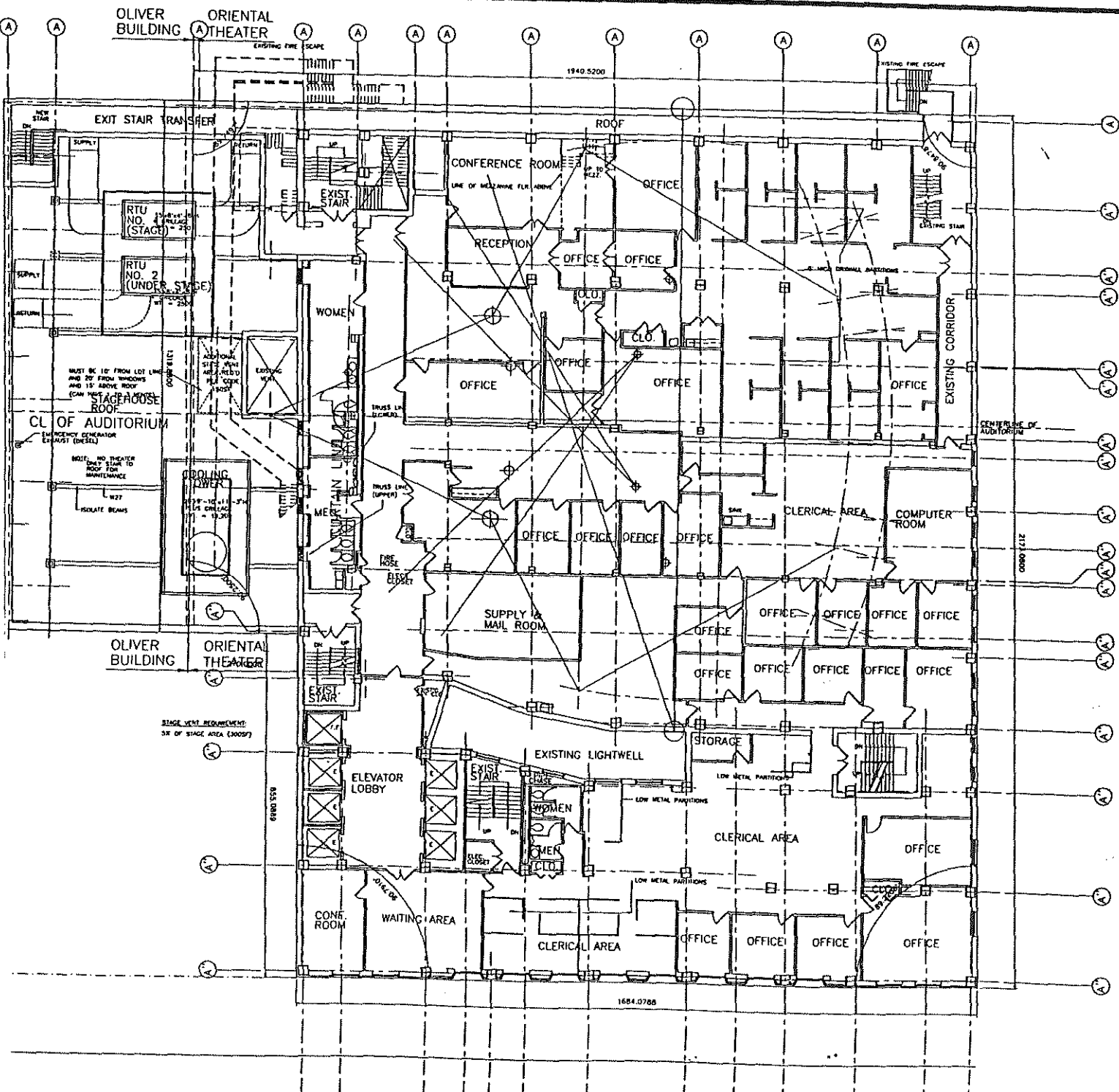

Project:
Oriental Theater
 Redevelopment

24 West Randolph
 Chicago, Illinois

Owner:
Livent (U.S.) Inc.

Suite 600
 185 Avenue Road
 Toronto, Ontario M5R 2H7

Project Manager:
Kofman Engineering, Ltd.

Suite 501
 185 Avenue Road
 Toronto, Ontario M5R 3J4
 (416) 923-7183

Architect:
Daniel P. Coffey & Associates, Ltd.

Suite 5750
 233 South Wacker Drive
 Chicago, Illinois 60605
 (312) 362-9898

Structural Engineer:
Voiles Partnership, Inc.

Suite 200
 183 Queen St. East
 Toronto, Ontario M5A 1S1

Mechanical/Electrical Engineer:
Environmental System Design, Inc.

Suite 1850
 25 East Monroe
 Chicago, Illinois 60603

Acoustical Engineer:
John Swallow Associates

230 Colony Boulevard
 Etobicoke, Ontario M9W 5R8

No. REVISION DATE

Drawing Title:
Ninth Floor (91'-0")

Scale: 1/8" = 1'-0"
 Date: 28 March 1996
 Project Number: P507
 Drawing Name: NINTH0.DWG

Project:

Oriental Theater Redevelopment

24 West Randolph Chicago, Illinois

Owner:

Livent (U.S.) Inc.

Scale:

1/16" = 1'-0"

1/8" = 1'-0"

1/4" = 1'-0"

1/2" = 1'-0"

3/4" = 1'-0"

1" = 1'-0"

1 1/4" = 1'-0"

1 1/2" = 1'-0"

1 3/4" = 1'-0"

1 7/8" = 1'-0"

1 5/8" = 1'-0"

1 1/2" = 1'-0"

1 1/4" = 1'-0"

1 1/8" = 1'-0"

1 1/16" = 1'-0"

1 1/32" = 1'-0"

1 1/64" = 1'-0"

1 1/256" = 1'-0"

1 1/512" = 1'-0"

1 1/1024" = 1'-0"

1 1/2048" = 1'-0"

1 1/4096" = 1'-0"

1 1/8192" = 1'-0"

1 1/16384" = 1'-0"

1 1/32768" = 1'-0"

1 1/65536" = 1'-0"

1 1/131072" = 1'-0"

1 1/262144" = 1'-0"

1 1/524288" = 1'-0"

1 1/1048576" = 1'-0"

1 1/2097152" = 1'-0"

1 1/4194304" = 1'-0"

1 1/8388608" = 1'-0"

1 1/16777216" = 1'-0"

1 1/33554432" = 1'-0"

1 1/67108864" = 1'-0"

1 1/134217728" = 1'-0"

Longitudinal Section

Scale: 1/16" = 1'-0"
Date: 28 March 1986
Project Number: 1507
Drawing Name: SECTION
Drawing Number: 71

EL. 80'-0"
78'-0"
68'-2 1/2"
34'-6"

ROOF TOP UNIT BEYOND
COOLING TOWER

GRID IRON LEVEL
LOADING PLATFORM NO.1
LOADING PLATFORM NO.2

FLY FLOOR LEVEL

STAGE EL. 0'
TRAP EL. -2'

DRESSING EL. -21'-0"

OFFICE

OFFICE

OFFICE

OFFICE

OFFICE

OFFICE

OFFICE

TECH. BOOTH

TOILETS

LOBBY

LOBBY

LOBBY

TOILETS EL. -11'

-17'-0"

EL. -21'

PIT -9'-0"

REHEARSAL ROOM BEYOND -31'-0"

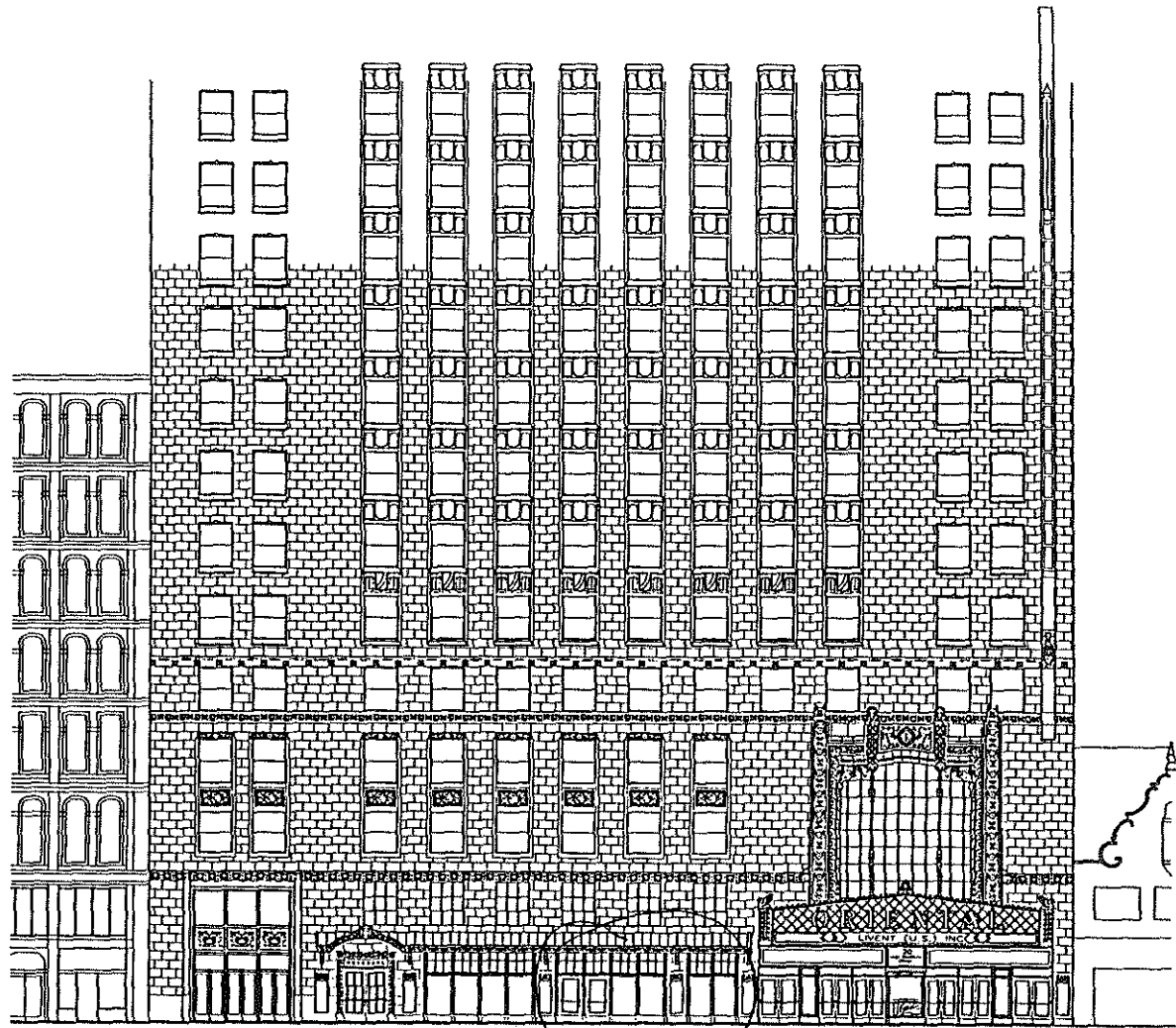

Project:

Oriental Theater Redevelopment

24 West Randolph
Chicago, Illinois

Owner:

Livent (U.S.) Inc.

Suite 800
185 Avenue Road
Toronto, Ontario M5R 2H7

Project Manager:

Kofman Engineering, Ltd.

Suite 501
185 Avenue Road
Toronto, Ontario M5R 3S4
(416) 925 - 7183

Architect:

Daniel P. Coffey
& Associates, Ltd.

Suite 5730
233 South Wacker Drive
Chicago, Illinois 60606
(312) 382 - 8098

Structural Engineer:
Yolles Partnership, Inc.

Suite 200
183 Queen St. East
Toronto, Ontario M5A 1S1

Mechanical/Electrical Engineer:
Environmental
System Design, Inc.

Suite 1800
55 East Monroe
Chicago, Illinois 60603

Acoustical Engineer:
John Swallow
Associates

250 Gallery Boulevard
Etobicoke, Ontario M9W 5R8

Engineer:

No. REVISION DATE

Drawing Title:

Randolph
Elevation

0 2' 4' 8' 16'

Scale: 1/8" = 1'-0"

Date: 28 March 1998

Project Number: 9507

Drawing Name: SIXTH110.DWG

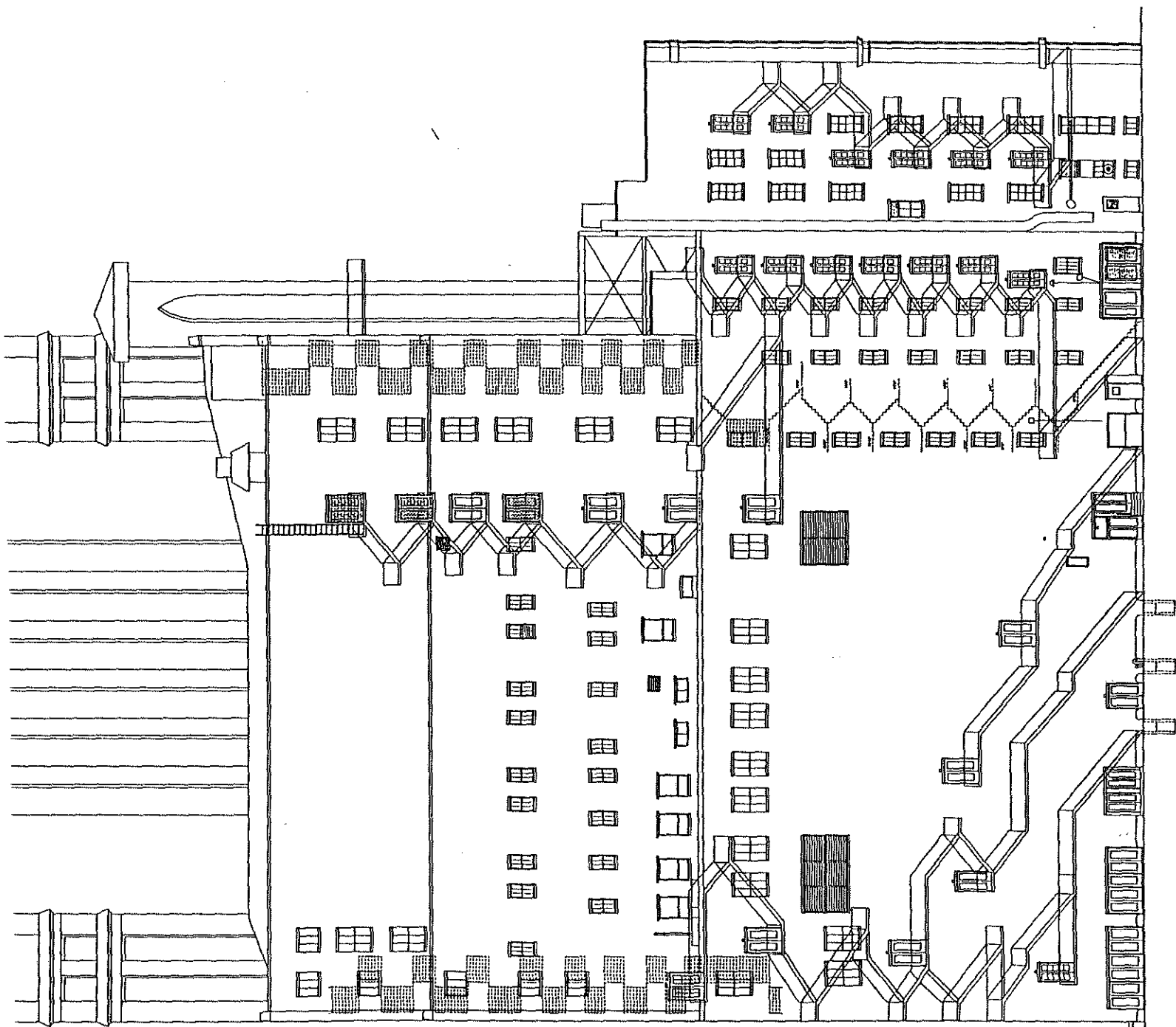

Project:
Oriental Theater
 Redevelopment
 24 West Randolph
 Chicago, Illinois

Owner:
Livent (U.S.) Inc.

Suite 800
 185 Avenue Road
 Toronto, Ontario M5R 2H7

Project Manager:
Kofman Engineering, Ltd.

Suite 501
 185 Avenue Road
 Toronto, Ontario M5R 3S4
 (416) 975 - 7183

Architect:
Daniel P. Coffey & Associates, Ltd.

Suite 3750
 233 South Wacker Drive
 Chicago, Illinois 60608
 (312) 382 - 8888

Structural Engineer:
Yoffes Partnership, Inc.

Suite 200
 183 Queen St. East
 Toronto, Ontario M5A 1S1

Mechanical/Electrical Engineer:
Environmental System Design, Inc.

Suite 1640
 35 East Monroe
 Chicago, Illinois 60603

Acoustical Engineer:
John Swallow Associates

250 Colony Boulevard
 Etobicoke, Ontario M9W 5R8

Engineer:

No. REVISION DATE
 Drawing Title:
Couch Place Elevation

0 2' 4' 8' 16'
 Scale: 1/8" = 1'-0"
 Date: 28 March 1998
 Project Number: 9507
 Drawing Name: EL-N-EXDRG

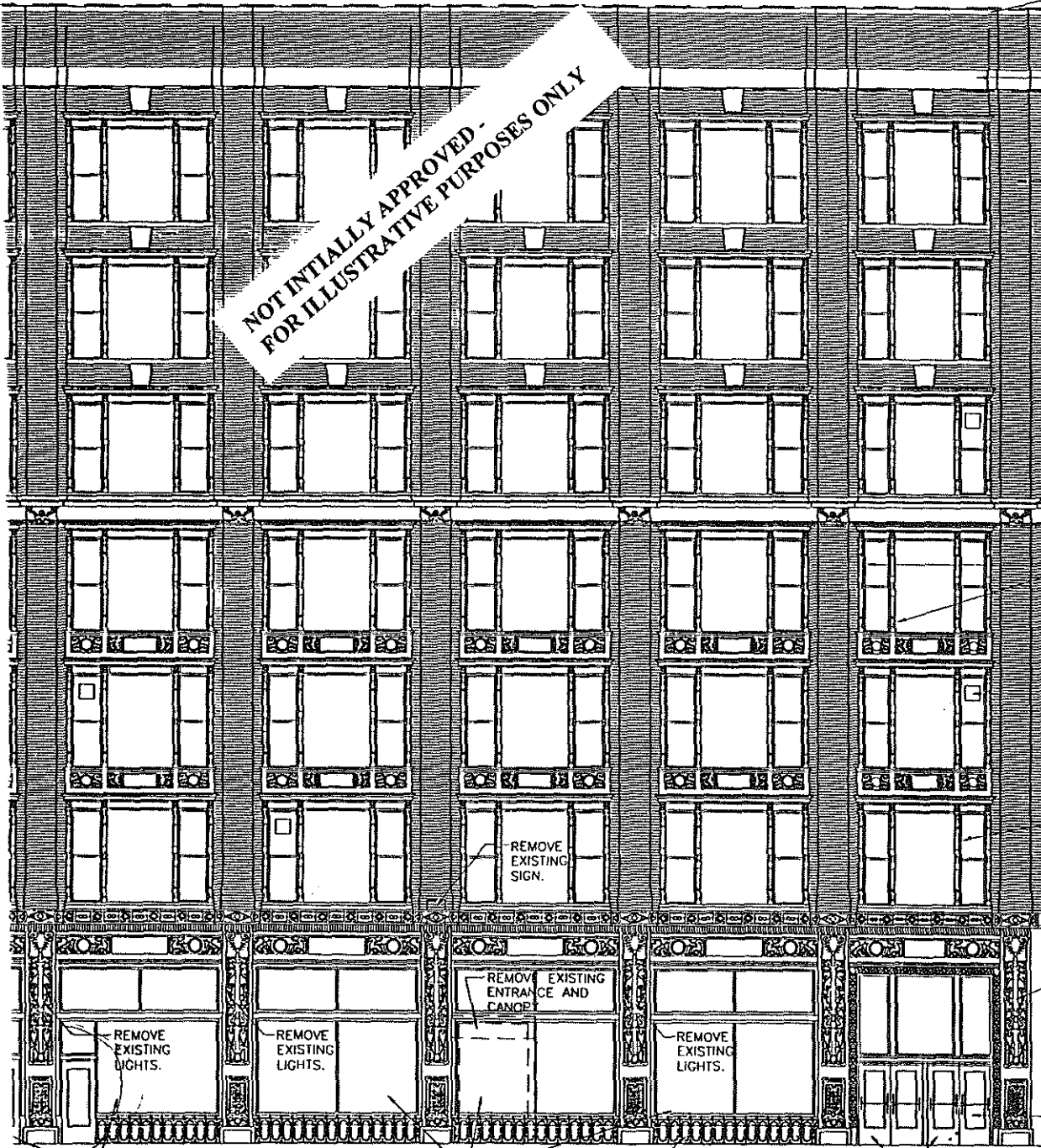

**NOT INITIALLY APPROVED -
FOR ILLUSTRATIVE PURPOSES ONLY**

SAW OUT EXISTING JOINTS IN PARAPET CAP AND INSTALL NEW SEALANT.

REMOVE EXISTING DAMAGED PARPING AND PATCH. (OPTION : REPLICATE CORNICE FROM 1920 ADDITION)

CLEAN ALL MASONRY, TERRA COTTA AND BRICK SURFACES WITH MASONRY RESTORATION CLEANER. SAW CUT OUT ALL MORTAR JOINTS TO A DEPTH OF 1/2" AND REPOINT ALL JOINTS WITH NEW MORTAR (CONCAVE STRUCK)

REMOVE EXISTING PAINT FROM EXISTING CAST IRON MULLIONS AND TRIM. REPAINT IN HISTORIC COLOR SCHEME.

REMOVE ALL EXISTING VENT/LOUVERS AND REGLAZE EXISTING OPENINGS WITH CLEAR GLASS.

REPAINT EXISTING WINDOWS IN HISTORIC COLOR SCHEME.

CLEAN AND REPAINT EXISTING CAST IRON ORNAMENTATION IN HISTORIC COLOR SCHEME.

NEW GLASS AND METAL DOOR.

REMOVE EXISTING SIGN.

REMOVE EXISTING ENTRANCE AND CANOPY

REMOVE EXISTING LIGHTS.

REMOVE EXISTING LIGHTS.

REMOVE EXISTING LIGHTS.

NEW PAINTED ALUMINUM STORE FRONT WITH CLEAR GLASS AND METAL AND GLASS

EXISTING WROUGHT IRON BUILDING SIGN

NEW GLASS AND METAL DOOR.

Project:

Oriental Theater Redevelopment

24 West Randolph
Chicago, Illinois

Owner:

Livent (U.S.) Inc.

Suite 600
165 Avenue Road
Toronto, Ontario M5R 2H7

Project Manager:

Kofman Engineering, Ltd.

Suite 501
165 Avenue Road
Toronto, Ontario M5R 3S4
(416) 925 - 7163

Architect:

Daniel P. Coffey
& Associates, Ltd.

Suite 5750
233 South Wacker Drive
Chicago, Illinois 60606
(312) 382 - 9898

Structural Engineer:

Yolles Partnership, Inc.

Suite 200
183 Queen St. East
Toronto, Ontario M5A 1S1

Mechanical/Electrical Engineer:

Environmental
System Design, Inc.

Suite 1850
25 East Monroe
Chicago, Illinois 60603

Acoustical Engineer:

John Swallow
Associates

230 Galaxy Boulevard
Etobicoke, Ontario M9W 0R6

Engineer:

No. REVISION DATE

Drawing Title:

Oliver Building Elevation

0 3' 6' 9' 12'

Scale: 1/4" = 1'-0"

Date: 26 March 1996

Project Number: 9507

Drawing Name: EL-OLIVEDWG

SUB-BASEMENT FOUNDATIONS

1. CHECKED BY: [blank] DRAWN BY: [blank] CHECKED BY: [blank] DATE: [blank]
2. FOUNDATIONS OF EXISTING BUILDING TO REMAIN AS SHOWN ON PLAN OR PART OF THE EXISTING FOUNDATION TO REMAIN AS SHOWN ON PLAN
3. CHECK ALL EXISTING UNDER EXISTING FOUNDATIONS AS SHOWN ON PLAN
4. ALL DIMENSIONS, UNLESS OTHERWISE SPECIFIED, ARE IN FEET AND INCHES
5. LOCATION OF EXISTING JOINTS SHOWN WITH "A" OR "B"
6. ALL FOUNDATIONS SHOULD BE CONCRETE WITH REINFORCEMENT AT ALL SURFACES EXPOSED TO WEATHER

THE ORIENTAL THEATER

20 West Randolph
CHICAGO ILLINOIS

Livent (US) Inc.

Site: 001
100 N. LaSalle Road
Tomball, Texas 77455
Project Manager: [blank]

Kofman Engineering Ltd.

Suite 201
885 Avenue Road
Toronto, Ontario M5R 2B7
416-925-1180

Job No. 90201



Showing The
SUB-BASEMENT FOUNDATIONS

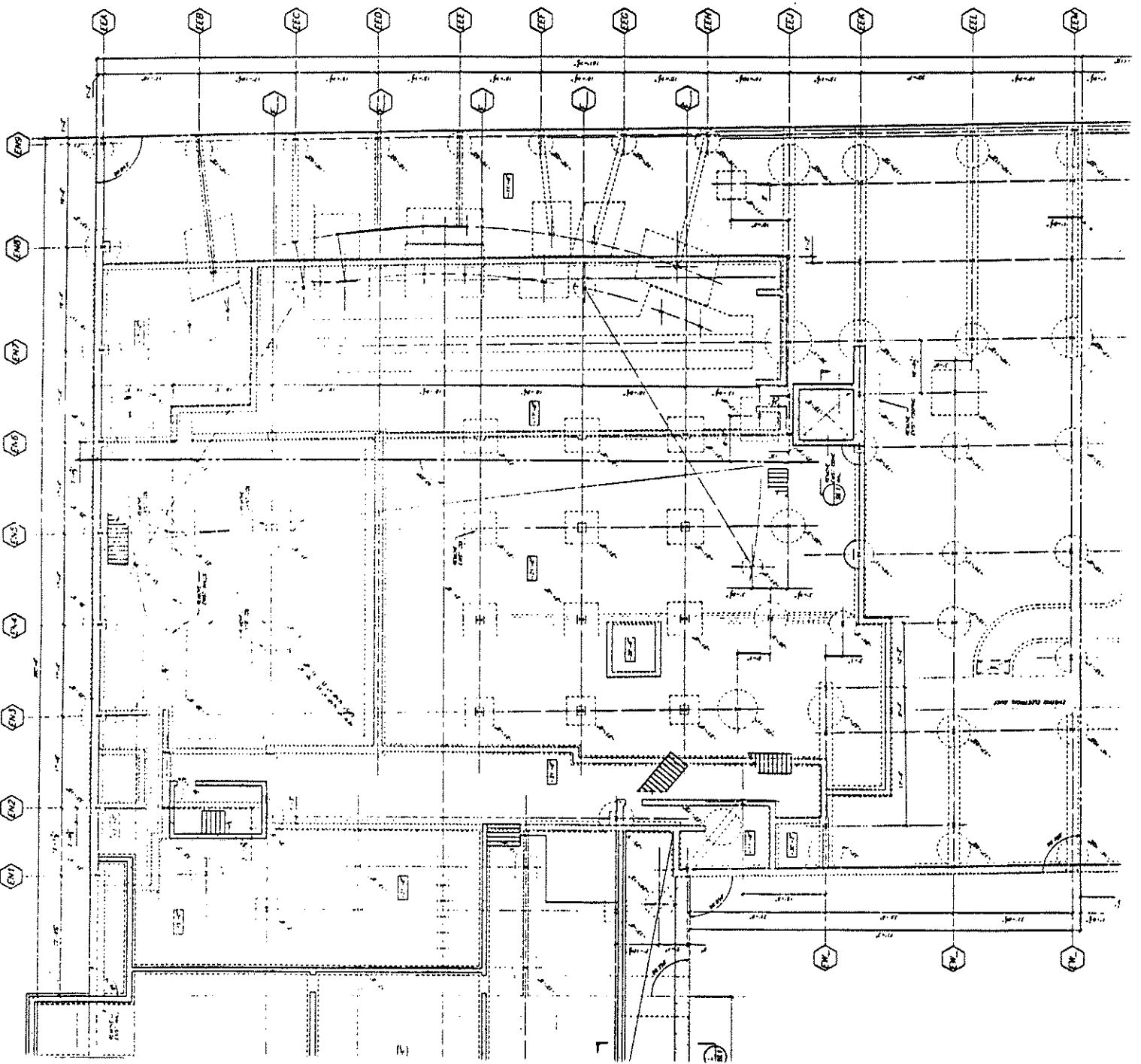

THE
ORIENTAL
THEATER

20 West Randolph
CHICAGO ILLINOIS

Livent (U.S.) Inc.

Scale 0/0
165 Avenue Road
Toronto Ontario M5R 2R7
Project Manager: Archibald

Kofman Engineering Ltd.

Scale: 3/11
165 Avenue Road
Toronto Ontario M5R 2R7
MIB 527/1103

Rev. No. 002/1

rolles
ARCHITECTS
165 AVENUE ROAD
TORONTO ONTARIO M5R 2R7
CANADA

Showing The
**BASEMENT TRAP
FRAMING PLAN**

Scale
0 10 20
Feet

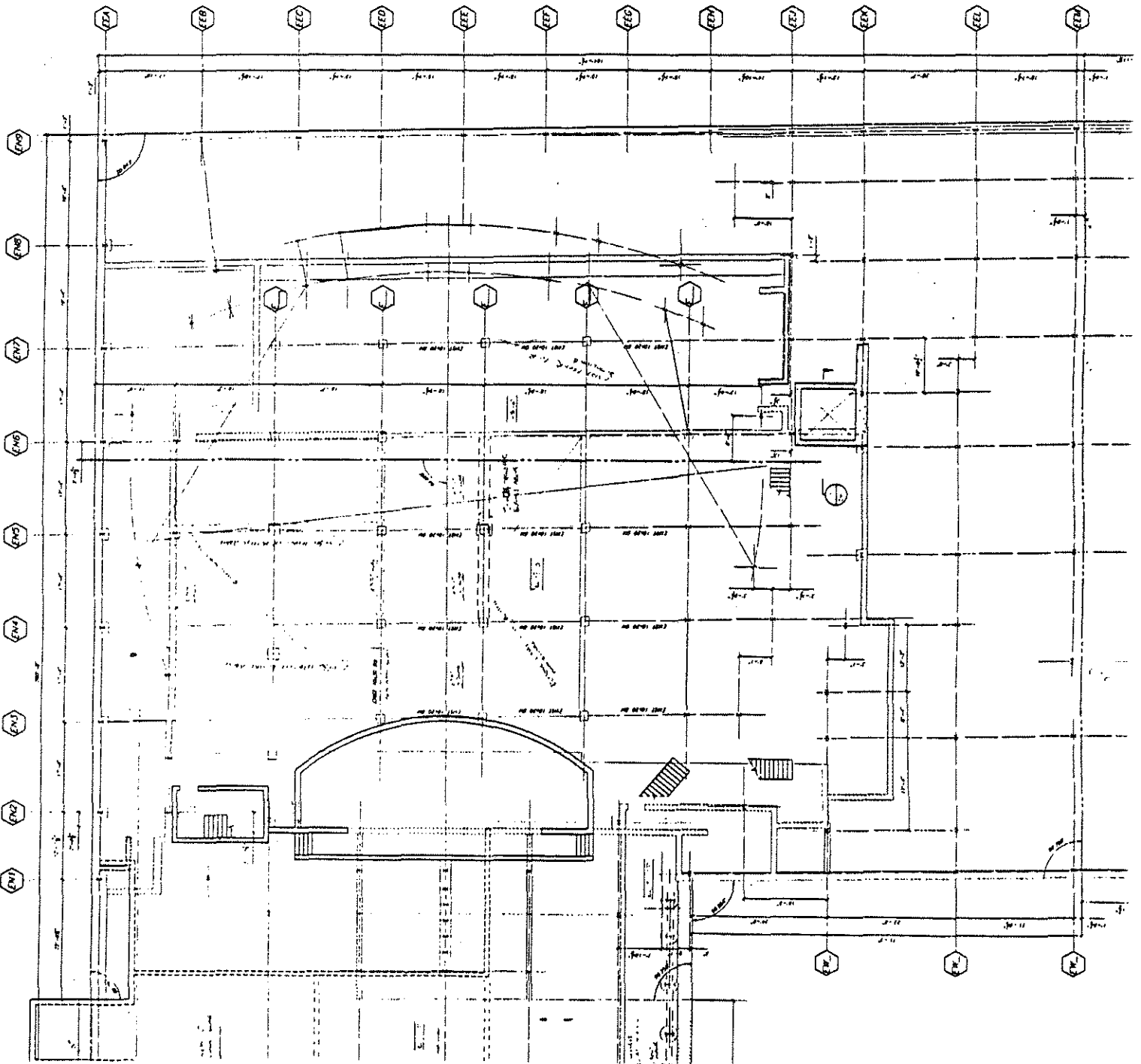

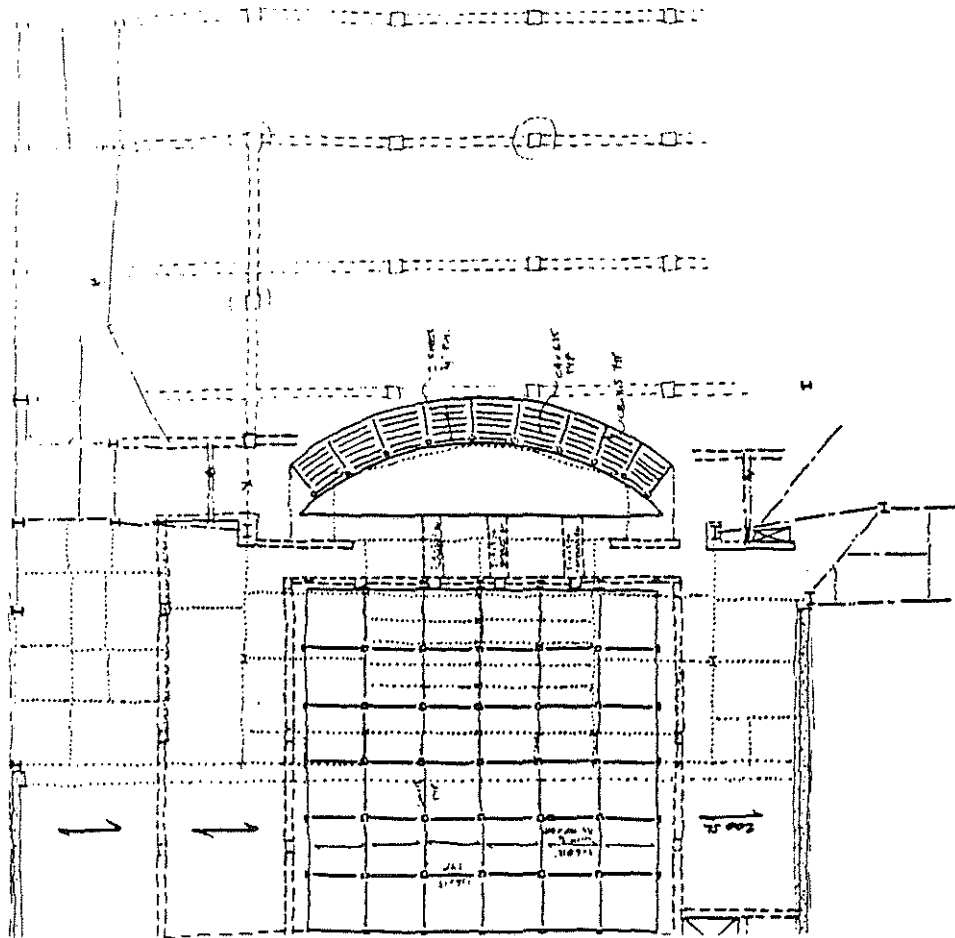

THE
ORIENTAL
THEATER

20 West Randolph
CHICAGO ILLINOIS

Livent (U.S.) Inc.

Suite 609
185 Avenue Road
Toronto, Ontario M5R 2K7

Project Manager: J. Roberts

Korffman Engineering Ltd.

Suite 301
185 Avenue Road
Toronto, Ontario M5R 2K7
416 352-7183

Job No. 16221

yolles

100 King Street West
Toronto, Ontario M5X 1C5
416 593-8888

Drawing Title
OF CONTRACTOR WORK FOR THE
PROJECT (AS SET GROUPS FOR)

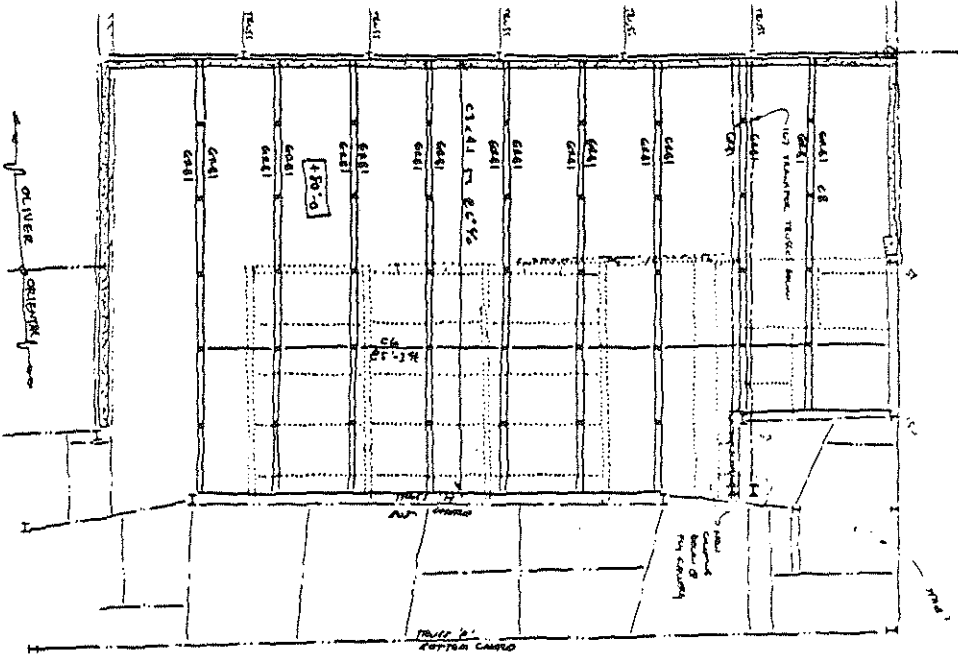

THE
ORIENTAL
 THEATER

20 West Randolph
 CHICAGO, ILLINOIS

Livent (U.S.) Inc.

Suite 600
 185 Avenue Road
 Toronto, Ontario M5R 2T8
 Project Manager: Jackson

Kofman Engineering Ltd.

Scale 3/16"
 180 Avenue Road
 Toronto, Ontario M5R 2T8
 416-291-7183

Yolles
 ARCHITECTS

April 10, 1971

Drawing Title
 Location: Purcell/S&O
 Level: Existing Floor
 (Examine Site Plans)

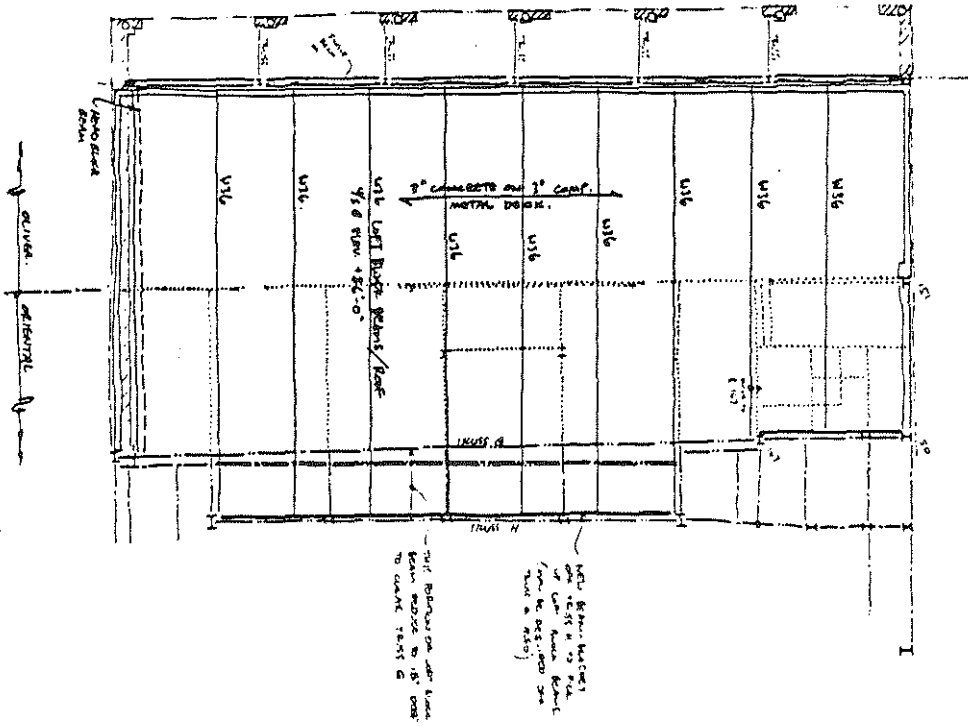

DO NOT REMOVE FROM THIS DRAWING
 FOR USE IN ANY OTHER PROJECT
 WITHOUT THE WRITTEN PERMISSION OF
 THE ARCHITECT

DO NOT REMOVE FROM THIS DRAWING
 FOR USE IN ANY OTHER PROJECT
 WITHOUT THE WRITTEN PERMISSION OF
 THE ARCHITECT

THE
ORIENTAL
 THEATRE

200 West Randolph
 CHICAGO ILLINOIS

Livent (US) Inc.

504-528-1800
 180 West Lake
 Torrance, CA 90501

Kofman Engineering Ltd

500-501
 180 Avenue Road
 Toronto, Ontario M5V 2R1
 416-593-1180

yolles

1000
 1000
 1000
 1000

Operating For
 STACY DONK EYE ESTATE
 1000 (1000-1000)

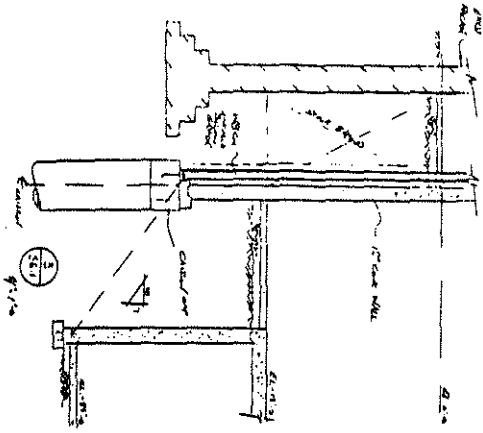
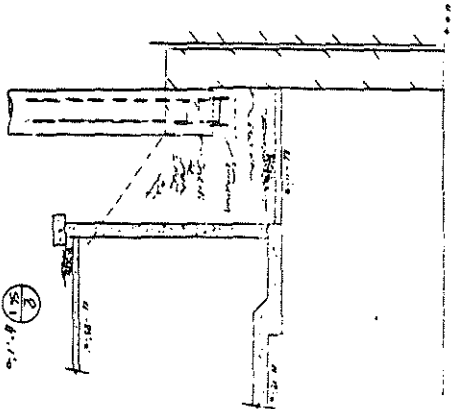

THE
ORIENTAL
THEATRE

20 West Randolph
CHICAGO ILLINOIS

Livent (U.S.) Inc.

200 West Randolph
Chicago, Illinois 60601
Project Manager: Architect

Kelman Engineering Ltd.

200 West Randolph
Chicago, Illinois 60601
110 West 11th

volles

Drawing Title

DETAIL



SECTION LOOKING SOUTH
BY SITE

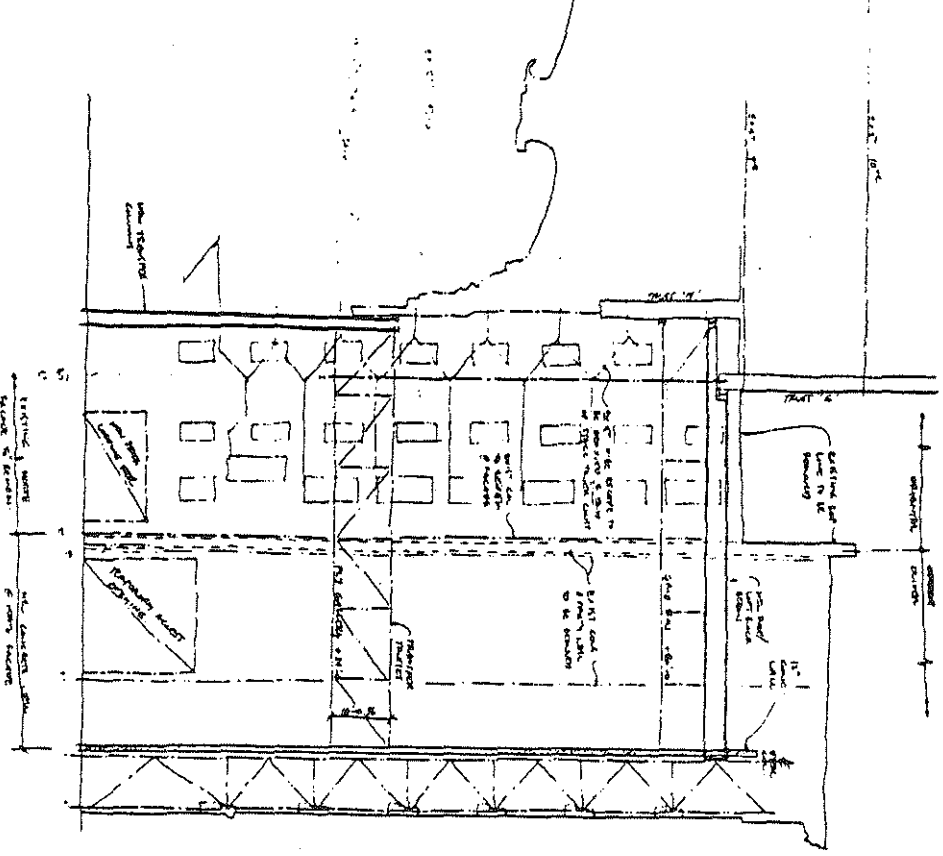

THE
ORIENTAL
THEATER

20 West Randolph
CHICAGO, ILLINOIS

Livent (U.S.) Inc.

Suite 602
165 Avenue Road
Toronto, Ontario M5R 2H7
Project Manager: Alexander

Kolman Engineering Ltd.

Suite 501
165 Avenue Road
Toronto, Ontario M5R 2H7
416-597-1118

yolles
ARCHITECTS

March 1971

Drawing Title
SECTION LOOKING SOUTH
(6 SHEETS DRAWING SECTION)

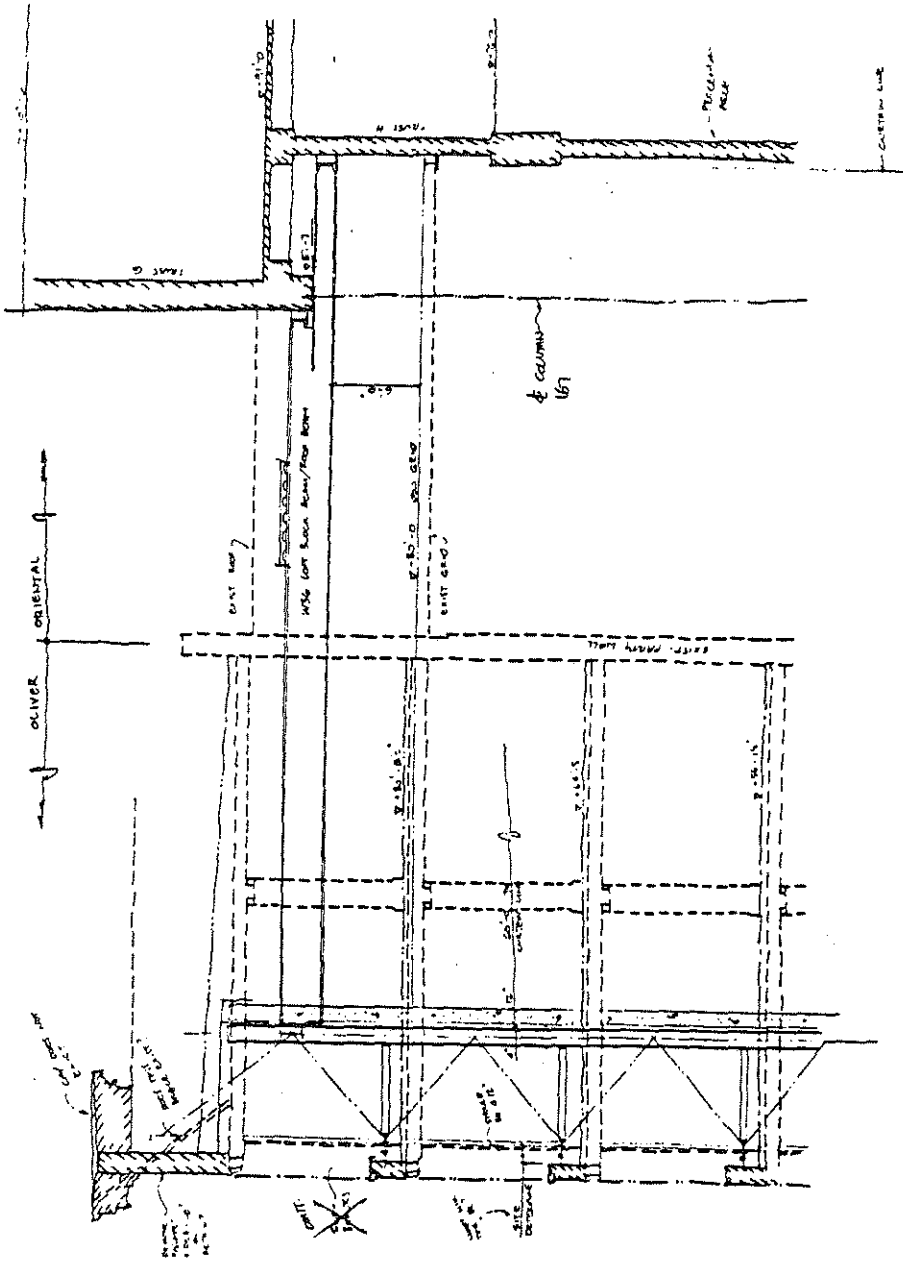

THE ORIENTAL
THEATER

20 West Randolph
CHICAGO ILLINOIS

Livent (U.S.) Inc.

Suite 400
155 Avenue Road
Toronto Ontario M5R 2K7
Project Manager: Andrew

Kofman Engineering Ltd

Suite 501
185 Avenue Road
Toronto Ontario M5R 2K7
416 525-1183

AP No P071

yolles
ARCHITECTS
100 BAYVIEW AVE
SUITE 1000
TORONTO ONTARIO M5S 1A5
416 461-8888

Drawings by
BALOGH DESIGN

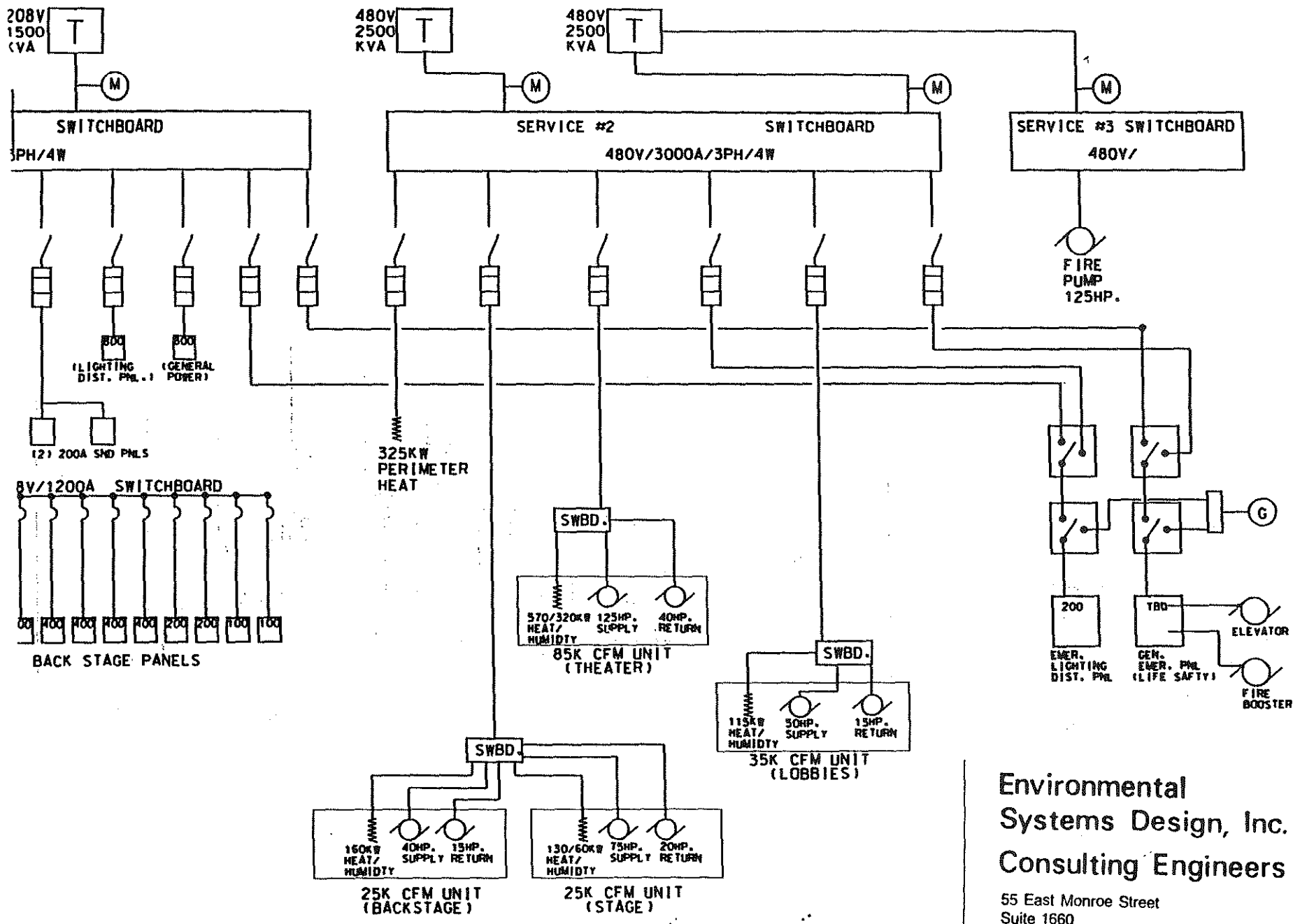

**Environmental
Systems Design, Inc.
Consulting Engineers**

55 East Monroe Street
Suite 1660
Chicago, Illinois 60603
(312) 372-1000

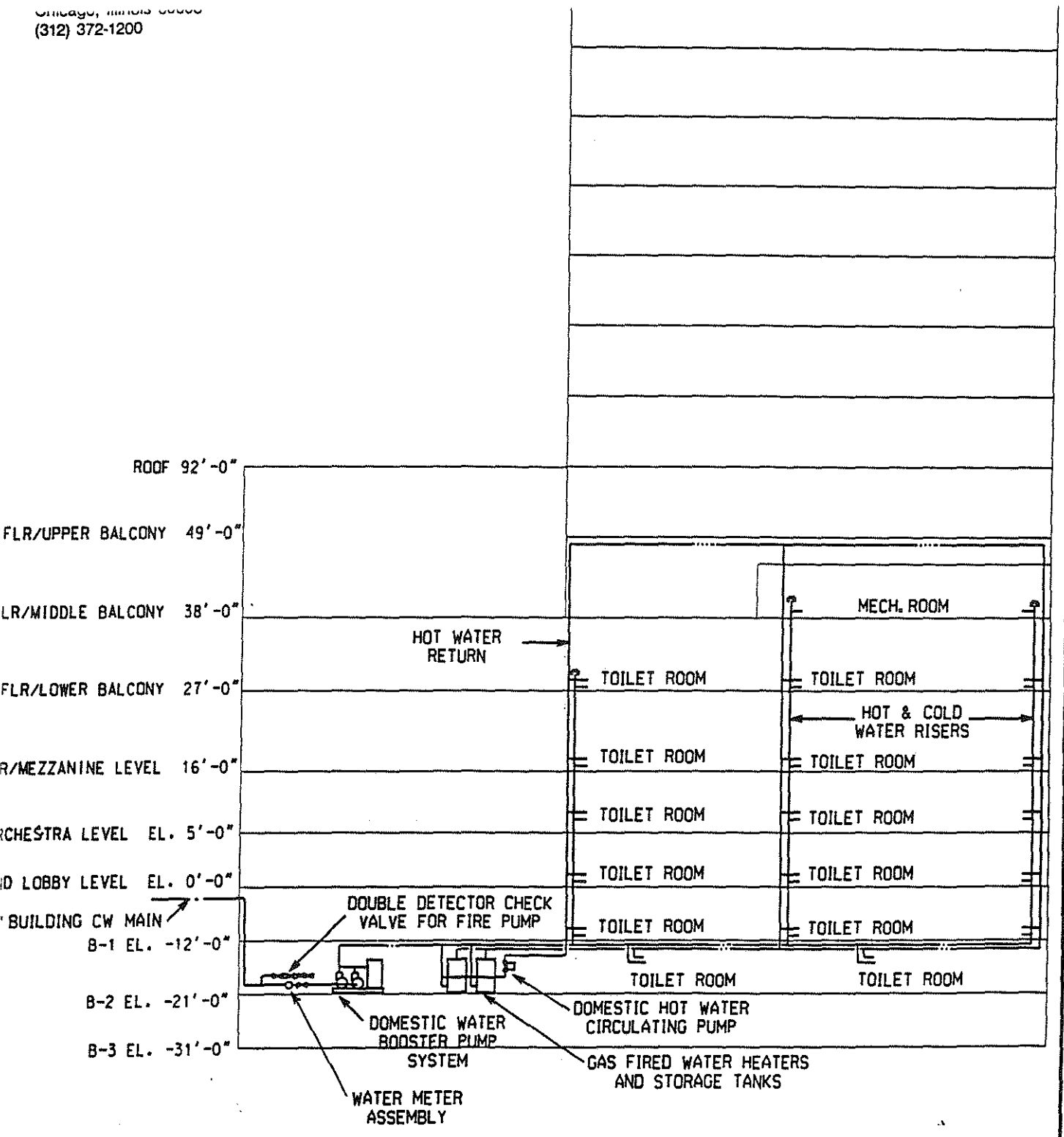

ORIENTAL THEATER DOMESTIC HOT AND COLD WATER SYSTEMS DIAGRAM

5 MARCH, 1996

SUPPLEMENT TO BUDGET FOR MBE/WBE PARTICIPATION

**ORIENTAL THEATER
PROJECT 94-368**

1.0 W/MBE EXCLUSIONS

1.1 Subcontracts under the General Contract which are excluded from W/MBE requirements.

1.17	Finish Carpentry (Millwork)	400,000
1.23	Canopies and Marquee	200,000
1.30	Decorative Plaster	200,000
1.32	Decorative Painting	1,000,000
1.33	Stretchwall and Acoustic Panels	50,000

Sub-Total	<u>\$1,850,000</u>
Allocation of Contingency @ 8.2%	151,500

Total Exclusion from General Contract	<u>\$2,001,500</u>
--	---------------------------

1.2 The following specialty contracts are contracted directly to Livent and are excluded from W/MBE requirements.

2.1	Theatre Lighting	300,000
2.2	Theatre Sound	100,000
2.3	Theatre Rigging	900,000
2.4	Theatre Drapes	100,000
2.5	FOH Drapes	150,000
3.1	Carpet Supply	250,000
3.3	Exterior Signage	180,000
3.5	Theatre Seating	500,000
3.6	Bar Equipment	150,000
3.7	Reception Room Furniture	40,000

Sub-Total	<u>\$2,670,000</u>
Allocation of Contingency @ 8.2%	218,500

Total Exclusions from Specialty Contracts	<u>\$2,888,500</u>
--	---------------------------

TOTAL W/MBE EXCLUSIONS (Subject of Special Waiver) **\$4,890,000** *

* Notwithstanding special waiver of such items/amounts from MBE/WBE commitment per Sec. 6.3 of Redevelopment Agreement, Developer has agreed to use its best efforts to use MBES and WBES when possible.

2.0 W/MBE INCLUSIONS

2.1	Total Hard (Construction) Costs Per Budget	\$18,000,000
2.2	Plus: Construction Contingency at 8.2%	1,472,171
		<u>\$19,472,171</u>
2.3	Less: Total W/MBE Exclusions	(4,890,000)
	TOTAL W/MBE INCLUSIONS	\$14,582,171 **

** Items/amounts to which 25/5% MBE/WBE participation are committed to be applied per Sec. 6.3 of Redevelopment Agreement.

**ORIENTAL THEATER
PROJECT 94-368
LIST OF COMPONENT WORK AND SPECIALTY WORK**

- Drywall.
- Plaster.
- Decorative work.

1.5 Balance Finishes

- Finishes.
- Paint.
- Door hardware.
- Doors and frames.

2.0 SPECIALTY WORK

2.1 Theatre Specialties

- Theatre Lighting Equipment
- Theatre Sound
- Theatre Rigging
- Theatre Drapes
- FOH Drapes

2.2 Furniture, Fixtures and Equipment

- Carpet Supply
- Interior Directional Signage
- Exterior Signage
- Security
- Theatre Seating
- Bar Equipment
- Reception Room Furniture
- Lockers
- Miscellaneous

**ORIENTAL THEATER
PROJECT 94-368**

DESCRIPTION OF CONTRACT PACKAGES

The following describe unique components to be used in the restoration and reconstruction of the Oriental Theater. The specialty manufacturers, suppliers and artisans who provide these unique services, occupy a niche in the construction industry; therefore, their numbers are limited and we have requested certain W/MBE and residency waivers.

1.17 Millwork

Specialty, finished millwork is manufactured by store fixturing millwork shops familiar to the theatre requirements of Livent. The work includes bar and vanity wood cabinetry, wood toilet partitions and doors, and retail counters fabricated off site and shipped to the site for installation.

1.23 Canopies and Marquee/Exterior Signage

The canopies and marquee will be fabricated in the period style of the theater. Exterior signage, although modern in function, will also be fabricated in period style. These manufacturers tend to be very specialized, covering all of the North American market.

1.30 Decorative Plaster

Specialized moulding and application of plaster elements to match the theater designs, replacing broken, destroyed or missing elements. These elements are created by artisans specializing in theater restoration.

1.32 Decorative Painting

Specialized finishes applied on surfaces in the public areas, stripping old coatings, cleaning, faux finish replication, gilding and staining, coating, restoring. This is a specialized service provided by restoration type artisans.

**ORIENTAL THEATER
PROJECT 94-368**

1.33 Fabric Covered Walls and Acoustic Panels

Installation of patented sound absorption materials used to meet the overall acoustic criteria of the theater.

2.1 & 2.2. Theater Lighting and Sound

Supply and installation of specialty theater related lighting and sound equipment. These companies tend to be few in number and very specialized, covering all of North America.

2.3 Theater Rigging

Supply and installation of rigging, including counterweights, battens, loft blocks, head blocks, hoists, fire curtain, and pin rails. Again, there are, at most, a half dozen of these specialty contractors in North America.

2.4 & 2.5 Theater and FOH Drapes

These are specialty drapes which meet stringent acoustics and flame spread criteria. These drapes are similarly supplied and installed by specialty theater contractors.

3.1 Carpet Supply

The carpet is a custom designed and manufactured product. Because of the custom design, the designers work with manufacturers to develop the historic patterns and colours.

3.3 Exterior Signage

Exterior signage is manufactured in period style.

3.5 Theater Seating

These are custom made theater seats. There are only a limited number of North American firms supplying this seating product.

**ORIENTAL THEATER
PROJECT 94-368**

3.6 Bar Equipment

Bar equipment is supplied from manufacturers specializing in food and beverage equipment.

3.7 Reception Room Furniture

Supply only of unique, one-of-a-kind pieces of furniture for a very specific decorating concept.

EXHIBIT F

REDEVELOPMENT PROJECT COSTS

The following costs are eligible Redevelopment Project Costs to be paid for or reimbursed by the City in conjunction with the terms and conditions of the Redevelopment Agreement between the City of Chicago ("City") and Livent Realty (Chicago), Inc. ("Developer"):

1. Acquisition costs for the Oliver Property.
2. Acquisition costs for the Oriental Property, in an amount not to exceed Three Million Eight Hundred Thousand Dollars (\$3,800,000).
3. Costs associated with the relocation of tenants from the Oliver Property.
4. Demolition Component Work costs (in the amount of \$700,000).
5. Project Renovation costs in the aggregate amount of Nine Million Dollars (\$9,000,000) plus any unused funds from the Demolition Component Work. The funds shall be disbursed through the Escrow described in Section 4.8(c) of the Redevelopment Agreement on a pro-rata basis with Developer's funds subsequent to the disbursement of all of Developer's Equity.

EXHIBIT G

MORTGAGE

THIS MORTGAGE ("Mortgage") is made as of this _____ day of _____, 1996 from Livent Realty (Chicago) Inc., a Delaware corporation ("Mortgagor"), to the CITY OF CHICAGO, an Illinois municipal corporation, having its principal office at City Hall, Chicago, Illinois 60602 ("City" or "Mortgagee").

RECITALS

WHEREAS, the City Council of the City, by ordinance adopted March 26, 1996, authorized the execution by Mortgagor and the City of that certain "Block 36, North Loop Project Redevelopment Agreement, Oriental Theater" dated as of April __, 1996 ("Redevelopment Agreement"); and

WHEREAS, all terms, unless defined herein, shall have the meaning ascribed for them in the Redevelopment Agreement; and

WHEREAS, the Redevelopment Agreement provides inter alia for the assembling of certain real property on Block 36 constituting the Site and legally described in Exhibit A attached hereto (for purposes of this Mortgage, the "Land"), and the subsequent development of the Project at the Site by Mortgagor; and

WHEREAS, the Project shall be undertaken by Mortgagor in part by utilizing the City's Financial Contribution in the aggregate amount of \$ _____ to pay for certain eligible Redevelopment Project Costs, as are further described in the Redevelopment Agreement; and

WHEREAS, the City's Financial Contribution has been derived from Incremental Taxes allocated to the City in accordance with the TIF Plan and the TIF Ordinances, and any use of the City's Financial Contribution must be in accordance with any laws, regulations and ordinances governing the use of such funds, including, without limitation, the Illinois Tax Increment Allocation Redevelopment Act, 65 ILCS 5/11-74.4-3 et seq. (1994) ("TIF Act"); and

WHEREAS, as consideration for the use of the City's Financial Contribution to complete the Project as well as the receipt of other benefits from the City as are described in the Redevelopment Agreement, Mortgagor has agreed to construct the Project in accordance with the terms and conditions of the Redevelopment Agreement, and subsequent to the issuance of the Certificate by Mortgagee until the expiration of the Term of the Agreement, to abide by certain use and performance covenants running with and affecting the Land, including, without limitation, those Use and Performance Covenants more particularly described in subsection 7.2 of the Redevelopment Agreement; and

WHEREAS, the failure of Mortgagor to perform under the terms of the Redevelopment Agreement and comply with the Use and Performance Covenants shall give rise to Mortgagee's right to seek to recapture the City's Financial Contribution, as further described herein and in that certain Covenant of Performance (hereinafter defined); and

WHEREAS, in conjunction with this Mortgage, Mortgagor has executed and delivered to the Mortgagee that certain covenant of performance ("Covenant of Performance") dated of even date herewith reflecting the recapture provisions of the City's Financial Contribution as are described in this Mortgage during the Enforceability Period (as defined in Section 3.1 below); and

WHEREAS, the City is desirous of securing the recapture provisions and obligations of Mortgagor described in the Redevelopment Agreement, the Covenant of Performance and in the Mortgage;

NOW, THEREFORE, to secure the performance and observance by Mortgagor of all the terms, covenants and conditions described in the Covenant of Performance and the Mortgage, and in order to charge the properties, interests and rights hereinafter described with such consideration, Mortgagor has executed and delivered the Mortgage and does hereby grant, convey, assign, mortgage, grant a security interest in, and confirm unto Mortgagee and its successors and assigns forever, all of the following described property (which is hereinafter sometimes referred to as "Mortgaged Property"), subject to the title matters, liens and encumbrances set forth in Exhibit B attached hereto:

(A) The Land;

(B) All structures and improvements of every nature whatsoever now or hereafter situated on the Land, including, without limitation, the Project, all fixtures of every kind and nature whatsoever which are or shall be attached to said buildings, structures or improvements, and now or hereafter owned by Mortgagor, including all extensions, additions, improvements, betterments, renewals and replacements of any of the foregoing ("Improvements");

(C) All tenements, easements, rights-of-way and rights used as a means of access to the Land and Improvements and appurtenances thereto now or hereafter belonging or pertaining thereto;

(D) All rents and issues of the Land and Improvements from time to time and all of the estate, right, title, interest, property, possession, claim and demand at law, as well as in equity of Mortgagor, in and to the same;

(E) All machinery, apparatus, equipment, appliances, floor covering, furniture, furnishings, supplies, materials, fittings, fixtures and other personal property of every kind and nature whatsoever, and all proceeds thereof, now or hereafter located on or in the Land and Improvements which is owned by Mortgagor.

All of the Land, Improvements, estate and property hereinabove described, real, personal and mixed, whether or not affixed or annexed, and all rights hereby conveyed and mortgaged are intended so to be as a unit and are hereby understood, agreed and declared, to the maximum extent permitted by law, to form a part and parcel of the Land and Improvements and to be appropriated to the use thereof, and shall for the purposes of the Mortgage deemed to be conveyed and mortgaged hereby; provided, however, as to any property aforesaid which does not so form a part and parcel of the Land and Improvements, the Mortgage is hereby deemed also to be a Security Agreement under the Uniform Commercial Code of the State of Illinois (the "Code") for the purposes of granting a security interest in such property, which Mortgagor hereby grants to Mortgagee as secured party (as defined in the Code) and as also contemplated and provided for in Section 5.4 hereof.

TO HAVE AND TO HOLD the Mortgaged Property and all parts thereof unto Mortgagee, its successors and assigns, to its own proper use, benefit and advantage forever, subject, however, to the terms, covenants and conditions herein;

WITHOUT limitation of the foregoing, Mortgagor hereby further grants unto Mortgagee, pursuant to the provisions of the Code, a security interest in all of the above-described property which are or are to become fixtures.

THIS MORTGAGE IS GIVEN TO SECURE: (a) payment of the recapture obligation in furtherance of the provisions evidenced by the terms of the Covenant of Performance and the Mortgage, and (b) performance of each and every of the covenants, conditions and agreements contained in the Covenant of Performance, the Mortgage and the Redevelopment Agreement, and in any other agreement, document or instrument to which reference is expressly made in the Mortgage relating to the development and use of the Land and Improvements.

SECTION I

INCORPORATION OF RECITALS

The recitals set forth above constitute an integral of the Mortgage and are hereby incorporated herein by this reference with the same force and effect as if set forth herein as agreements of the parties.

SECTION II

COVENANTS, REPRESENTATIONS AND WARRANTIES

Mortgagor covenants, represents and warrants to Mortgagee that:

2.1 Taxes and Assessments.

(a) Mortgagor will pay when due all general taxes and assessments, special assessments, water charges and all of the charges against the Mortgaged Property and shall, upon written request, furnish to Mortgagee receipts evidencing payment thereof, provided that Mortgagor, in good faith and with reasonable diligence, may contest the validity or amount of any such taxes, assessments or charges, provided that during any such contest the enforcement of the lien of such taxes, assessments or charges is stayed or is otherwise in compliance with the applicable provisions of the Redevelopment Agreement with respect thereto.

(b) Mortgagor will not suffer (unless bonded or insured over) any mechanic's, laborer's, materialmen's, or statutory lien to remain outstanding upon any of the Mortgaged Property. Mortgagor may contest such lien, provided that Mortgagor shall

first post a bond in the amount of the contested lien, or provide title insurance over such contested lien, and further provided that Mortgagor shall diligently prosecute the contested lien and cause the removal of the same.

2.2 Insurance.

Mortgagor shall keep the Mortgaged Property continuously insured in such amounts and against such risks as are required of Mortgagor by the Redevelopment Agreement, paying the premiums for said insurance as they become due. Policies of insurance shall name Mortgagee as an additional insured. All policies of insurance shall provide that the same shall not be cancelled, except upon sixty (60) days prior written notice to Mortgagee.

2.3 Maintenance of the Property.

(a) Mortgagor shall preserve and maintain the Mortgaged Property in good condition and repair, shall not commit or suffer any waste thereof, and shall keep the same in a clean, orderly and attractive condition. Mortgagor shall not do or suffer to be done anything which will increase the risk of fire or other hazard to the Mortgaged Property or any part thereof.

(b) If the Mortgaged Property or any part thereof is damaged by fire or any other cause, Mortgagor will immediately give written notice of the same to Mortgagee.

(c) Mortgagee or its representatives shall have the right to inspect the Mortgaged Property to assure compliance with the terms of the Mortgage and the Covenant of Performance.

(d) Mortgagor shall promptly comply, and cause the Mortgaged Property to comply, with all present and future laws, ordinances, orders, rules and regulations and other requirements of any governmental authority affecting the Mortgaged Property or any part thereof and with all instruments and documents of record or otherwise affecting the Mortgaged Property or any part thereof.

(e) If all or any part of the Mortgaged Property shall be damaged by fire or other casualty, Mortgagor shall comply with the terms and provisions of Section 4.14 of the Redevelopment Agreement.

2.4 Subordination.

Mortgagee by acceptance of the Mortgage acknowledges that the Mortgage, although otherwise intended to be a prior first lien on the Mortgaged Property and to be recorded in a manner to

provide such priority, shall nonetheless be subject and subordinate in all respects to any mortgage from Mortgagor in favor of a lender ("Senior Lender") providing financing for the Project or with respect to the Site related to satisfaction by Mortgagor of its Developer's Financial Contribution under the Redevelopment Agreement, whether given in connection with Completion of the Project or thereafter ("First Mortgage"), and shall also be subordinate to any mortgage ("Permanent Mortgage") that replaces the First Mortgage in an amount not to exceed Developer's Financial Contribution; provided, however, that such subordination shall be operative only for so long as Mortgagee, or such Senior Lender holding a permitted First Mortgage or Permanent Mortgage on the Mortgaged Property as aforesaid, agrees to perform and comply with Mortgagor's covenants under the Redevelopment Agreement if Mortgagor is in default thereunder after the time for curing such default thereunder has passed without a cure. The Redevelopment Agreement shall be recorded prior to, and have priority over, the Mortgage and any First Mortgage or Permanent Mortgage of the Senior Lender for the Term of the Agreement. Mortgagee shall deliver a separate instrument evidencing such subordination as may be reasonably required by a Senior Lender, provided that any such separate instrument of subordination is consistent with the provisions with respect to subordination of the Mortgage contained in the Redevelopment Agreement and the Mortgage.

SECTION III

RECAPTURE PROVISIONS

3.1 Generally.

The aggregate amount of the City's Financial Contribution made available to Mortgagor to pay for eligible Redevelopment Project Costs and, accordingly, that amount subject to recapture by the City in accordance with the terms and conditions of the Mortgage and the Covenant of Performance is \$_____ . Pursuant to the terms of the Redevelopment Agreement and the Mortgage, Mortgagor, from the execution date of the Mortgage until the expiration of the Term of the Agreement (such time period to be referred to as the "Enforceability Period"), shall construct the Project in accordance with the terms and conditions of the Redevelopment Agreement, and subsequent to the issuance of the Certificate by the City until the expiration of the Term of the Agreement, abide by the Use and Performance Covenants.

3.2 Recapture.

If, during the Enforceability Period, Mortgagor fails to construct the Project in accordance with the terms and conditions of the Redevelopment Agreement, or subsequent to the issuance of

the Certificate by the City, fails to perform in accordance with the Use and Performance Covenants, and after the delivery of written notice and the expiration of any applicable cure period (as described in Section V of the Redevelopment Agreement and Section IV of the Mortgage) the City shall be entitled to recapture, and Mortgagor shall be obligated to pay the City, an amount equal to the funds subject to recapture (as described in Section 3.1 above).

3.3 Release of Mortgage.

Upon the expiration of the Enforceability Period, if Mortgagor has complied with the Use and Performance Covenants to the satisfaction of Mortgagee, then Mortgagor shall be deemed to have fully complied with the provisions contained in the Mortgage, and Mortgagor shall be under no further obligation to Mortgagee. In such event, within thirty (30) days of receipt of a written request from Mortgagor, Mortgagee shall execute a release of the Mortgage. Said release shall be in recordable form.

SECTION IV

DEFAULT

4.1 Events of Default.

The terms "Event of Default" or "Events of Default", wherever used in the Mortgage, shall mean any one or more of the following events:

(a) Failure by Mortgagor to duly observe or perform any material term, covenant, condition, or agreement of the Covenant of Performance, the Mortgage, or the Redevelopment Agreement after the expiration of all cure periods as provided herein; or

(b) A default continuing beyond all applicable cure periods under the First Mortgage or Permanent Mortgage and permitting foreclosure thereunder.

4.2 Acceleration of Maturity.

(a) If an Event of Default due to a failure to make any payment when the same is due and owing ("Monetary Event of Default") shall have occurred under the Senior Lender's security documents, and shall have continued for ten (10) days following notice thereof from Mortgagee to Mortgagor, the amount of the City's Financial Contribution for which Mortgagor is then liable (as determined by Section 3.2 above) and secured hereby, at Mortgagee's sole option, shall become immediately due and payable without further notice or demand.

(b) If an Event of Default (other than a Monetary Event of Default), shall have occurred under the Senior Lender's security documents, the Redevelopment Agreement, the Covenant of Performance or the Mortgage, and shall have continued for sixty (60) days following the receipt of notice thereof from Mortgagee to Mortgagor, the amount of the City's Financial Contribution for

which Mortgagor is then liable (as determined by Section 3.2 above) and secured hereby, at Mortgagee's sole option, shall immediately become due and payable without further notice or demand; provided, however, that in the event such default cannot reasonably be cured within such sixty (60) day period and if Mortgagor has commenced efforts to cure, then the time to cure shall be extended so long as said party diligently continues to cure such default.

(c) Except as otherwise permitted by the terms of the Redevelopment Agreement, the Mortgage and as evidenced by Mortgagee's written consent, any sale, partial sale, refinancing, syndication or other disposition of the Mortgaged Property shall entitle the Mortgagee to declare the amount of City's Financial Contribution for which Mortgagor is then liable (as determined by Section 3.2 above) and secured hereby immediately due and payable without further notice or demand; provided, however, the replacement or substitution of any machinery, equipment or fixtures, now owned or hereafter acquired by Mortgagor, with machinery or equipment of like kind and value, whether or not such machinery or equipment is deemed a fixture under applicable provisions of the Code, will not be an Event of Default under the Mortgage, provided Mortgagor, if requested to do so by Mortgagee, executes such documents as may be necessary or deemed appropriate to assure Mortgagee of a continuing perfected secured interest in such replacement or substituted machinery, equipment or fixtures.

4.3 Remedies.

(a) Subject to the rights of the Senior Lender, when the City's Financial Contribution hereby secured, or any part thereof, shall become due on an Event of Default, Mortgagee shall have the right to foreclose the lien hereof for such indebtedness or part thereof. The Mortgage and the right of foreclosure hereunder shall not be impaired or exhausted by any foreclosure of the Senior Mortgage, and may be foreclosed successively and in parts, until all of the Mortgaged Property has been foreclosed against. In any such foreclosure, or upon the enforcement of any other remedy of Mortgagee under the Mortgage or the Covenant of Performance, there shall be allowed and included as additional indebtedness, all expenditures and expenses which may be paid or incurred by or on behalf of Mortgagee for reasonable attorneys' fees, appraisers' fees, outlays for documentary and expert

evidence, stenographers' charges, publication costs, and costs involved in title insurance and title examinations. All expenditures and expenses of the nature as described in this Section 4.3, and such expenses and fees as may be incurred in the protection of the Mortgaged Property and the maintenance of the lien of the Mortgage, including the reasonable fees of any attorney employed by Mortgagee in any litigation or proceeding affecting the Mortgage, the Covenant of Performance or the Mortgaged Property, including probate and bankruptcy proceedings, or in preparation for the commencement or defense of any proceeding or threatened suit or proceeding, shall be immediately due and payable by Mortgagor, with interest thereon at the lesser of the highest rate permitted by law or fifteen percent (15%) per annum, and shall be secured by the Mortgage. The proceeds of any foreclosure sale of the Mortgaged Property shall be distributed and applied in the following order of priority: (i) on account of all costs and expenses incidental to the foreclosure proceedings, including all such items as are mentioned in this section; (ii) all other items which under the terms hereof constitute secured indebtedness additional to that evidenced by the Covenant of Performance and the Mortgage; (iii) all amounts to be paid pursuant to the recapture provisions described in the Covenant of Performance; and (iv) any remaining amounts due to Mortgagor, its successors or assigns, as their rights may appear.

(b) Mortgagor shall not and will not apply for or avail itself of any appraisement, valuation, stay, extension or exemption laws, or any so-called "Moratorium Laws", now existing or hereafter enacted, in order to prevent or hinder the enforcement or foreclosure of the Mortgage, but hereby waives the benefit of such laws. Mortgagor, for itself and all who may claim through or under it, waives any and all right to have the property and estates comprising the Mortgaged Property marshalled upon any foreclosure of the lien hereof, and agrees that any court having jurisdiction to foreclose such lien may order the Mortgaged Property sold as an entirety. Mortgagor hereby waives any and all rights of redemption from sale under any order or decree of foreclosure of the Mortgage on its behalf and on behalf of each and every person, except decree or judgment creditors of Mortgagor, acquiring any interest in or title to the Mortgaged Property subsequent to the date of the Mortgage.

(c) Upon any other entering upon or taking of possession of the Mortgaged Property after the occurrence of an Event of Default and the expiration of the applicable cure period and other than by means of a foreclosure, Mortgagee, subject to the rights of the Senior Lender, may hold, use, manage and control the Mortgaged Property and, from time to time (i) make all necessary and proper maintenance, repairs, renewals, replacements, additions, betterments and improvements thereto and

thereon and purchase or otherwise acquire additional fixtures, personalty and other property required in connection therewith; (ii) insure or keep the Mortgaged Property insured; (iii) manage the Mortgaged Property and exercise all the rights and powers of Mortgagor to the same extent as Mortgagor could in its own name or otherwise with respect to the same; and (iv) enter into any and all agreements with respect to the exercise by others of any of the powers herein granted to Mortgagee, all as Mortgagee from time to time may reasonably determine to be to its best advantage. Mortgagee may collect and receive all the rents, issues, profits and revenues of the same, including those past due as well as those accruing thereafter, and, after deducting to the extent reasonable: (aa) expenses of taking, holding and managing the Mortgaged Property (including compensation for the services of all persons employed for such purposes); (bb) the cost of all such maintenance, repairs, renewals, replacements, additions, betterments, improvements and purchases and acquisitions; (cc) the cost of such insurance; (dd) such taxes, assessments and other similar charges as Mortgagee may determine to pay; (ee) other proper charges upon the Mortgaged Property or any part thereof; and (ff) the reasonable compensation, expenses and disbursements of the attorneys and agents of Mortgagee, shall apply the remainder of the monies and proceeds so received by Mortgagee to payment of the recapture obligations of Mortgagor under the Covenant of Performance. The balance of such funds, if any, after payment in full, of all of the aforesaid amounts shall be paid to Mortgagor.

4.4 Receiver.

Subject to the rights of the Senior Lender, if an Event of Default shall have occurred and be continuing after an applicable cure period has expired, Mortgagee, upon application to a court of competent jurisdiction, shall be entitled to the appointment of a receiver to take possession of and to operate the Mortgaged Property and to collect and apply the rents, issues, profits and revenues thereof. The receiver shall otherwise have all of the rights and powers to the fullest extent permitted by law.

4.5 Purchase by Mortgagee.

Upon any foreclosure sale, Mortgagee may bid for and purchase the Mortgaged Property and shall be entitled to apply all or any part of the indebtedness secured hereby as a credit to the purchase price; provided, however, that the Senior Lender has been paid in full.

4.6 Remedies Cumulative.

No right, power or remedy conferred upon or reserved to Mortgagee by the Mortgage is intended to be exclusive of any

other right, power or remedy, but each and every right, power and remedy shall be cumulative and concurrent and shall be in addition to any other right, power and remedy given hereunder or now or hereafter existing at law, in equity or by statute.

4.7 Waiver.

No delay or omission of Mortgagee or of any holder of the Note to exercise any right, power or remedy accruing upon any Event of Default shall exhaust or impair any such right, power or remedy or shall be construed to be a waiver of any such Event of Default or acquiescence therein; and every right, power and remedy given by the Mortgage to Mortgagee may be exercised from time to time as often as may be deemed expedient by Mortgagee. No consent or waiver, expressed or implied, by Mortgagee to or of any breach or Event of Default by Mortgagor in the performance of its obligations hereunder shall be deemed or construed to be a consent or waiver to or of any other breach or Event of Default in the performance of the same or any other obligations of Mortgagor hereunder. Failure on the part of Mortgagee to complain of any act or failure to act or to declare an Event of Default, irrespective of how long such failure continues, shall not constitute a waiver by Mortgagee of its rights hereunder or impair any rights, powers or remedies on account of any breach or default by Mortgagor.

SECTION V

MISCELLANEOUS PROVISIONS

5.1 Successors and Assigns.

The Mortgage shall inure to the benefit of and be binding upon Mortgagor and Mortgagee and their respective legal representatives, successors and assigns. Whenever a reference is made in the Mortgage to Mortgagor or to Mortgagee, such reference shall be deemed to include a reference to legal representatives, successors and assigns of Mortgagor or Mortgagee, as applicable.

5.2 Terminology.

All personal pronouns used in the Mortgage, whether used in the masculine, feminine or neuter gender, shall include all other genders; the singular shall include the plural, and vice versa. Titles and sections are for convenience only and neither limit nor amplify the provisions of the Mortgage, and all references herein to articles, sections or paragraphs shall refer to the corresponding articles, sections or paragraphs of the Mortgage unless specific reference is made to such articles, sections or paragraphs of another document or instrument.

5.3 Severability.

If any provision of the Mortgage or the application thereof to any person or circumstance shall be invalid or unenforceable to any extent, the remainder of the Mortgage and the application of such provision to other persons or circumstances shall not be affected thereby and shall be enforced to the extent permitted by law.

5.4 Security Agreement.

The Mortgage shall be construed as a "Security Agreement" within the meaning of and shall create a security interest under the Code as adopted by the State of Illinois with respect to any part of the Mortgaged Property which constitutes fixtures or personal property in which such a security interest is intended to be granted as provided in the Mortgage. Mortgagee shall have all the rights with respect to such fixtures and personal property afforded to it by said Code in addition to, but not in limitation of, the other rights afforded Mortgagee by the Mortgage or any other agreement.

5.5 Modification.

No change, amendment, modification, cancellation or discharge hereof, or of any part hereof, shall be valid unless in writing and signed by the parties hereto or their respective successors and assigns. Mortgagor shall have no right to convey the Land into a land trust without obtaining the prior written consent of the City.

5.6 No Merger.

It being the desire and intention of the parties that the Mortgage and the lien hereof do not merge in fee simple title to the Mortgaged Property, it is hereby understood and agreed that should Mortgagee acquire any additional or other interests in or to said property or the ownership thereof, then, unless a contrary interest is manifested by Mortgagee as evidenced by an appropriate document duly recorded, the Mortgage and the lien hereof shall not merge in the fee simple title, toward the end that this Mortgage may be foreclosed as if owned by a stranger to the fee simple title.

5.7 Applicable Law.

This Mortgage is submitted to the City at City Hall in the City of Chicago, State of Illinois, and shall be deemed to have been made thereat. This Mortgage shall be governed and controlled as to interpretation, enforcement, validity, construction, effect and in all other respects by the laws, statutes and decisions of the State of Illinois. Mortgagor, in

order to induce the City to accept this Mortgage, and for other good and valuable consideration, the receipt and sufficiency of which are hereby acknowledged, agree that all actions or proceedings arising directly, indirectly or otherwise in connection with, out of, related to or from this Mortgage shall be litigated, at the City's sole discretion and election, only in courts having a situs within the County of Cook, State of Illinois. Mortgagor hereby consents and submits to the jurisdiction of any local, state or federal court located within said county and state. To the extent permitted by law, Mortgagor hereby knowingly, voluntarily and intentionally waives the right it may have to a trial by jury in any litigation based hereon, or arising out of, under or in connection with this Mortgage and any agreement contemplated to be executed in conjunction herewith. This provision is a material inducement for the City to enter into the Redevelopment Agreement with Mortgagor.

IN WITNESS WHEREOF, the undersigned has caused this Mortgage to be executed as of the day and year first above written.

LIVENT REALTY (CHICAGO) INC.,
a Delaware corporation

By: _____
Garth H. Drabinsky
Chairman

By: _____
Myron I. Gottlieb
President

Prepared by and to be returned to:

Mark Lenz
Assistant Corporation Counsel
City of Chicago
121 North LaSalle Street
Chicago, Illinois 60602
312/744-1041

STATE OF ILLINOIS)
) SS
COUNTY OF COOK)

I, _____, a Notary Public in and for said County, in the State aforesaid, do hereby certify that Garth H. Drabinsky, personally known to me to be the Chairman of Livent Realty (Chicago) Inc., a Delaware corporation, personally known to me to be the same person whose name is subscribed to the foregoing instrument, appeared before me this day in person and being first duly sworn by me acknowledged that as such Secretary, he signed and delivered the said instrument, pursuant to authority given by Livent Realty (Chicago) Inc., as his free and voluntary act and as the free and voluntary act of said corporation, for the uses and purposes therein set forth.

GIVEN under my hand and notarial seal this ____ day of _____, 1996.

Notary Public

(SEAL)

My Commission expires _____.

STATE OF ILLINOIS)
) SS
COUNTY OF COOK)

I, _____, a Notary Public in and for said County, in the State aforesaid, do hereby certify that Myron I. Gottlieb, personally known to me to be the President of Livent Realty (Chicago) Inc., a Delaware corporation, personally known to me to be the same person whose name is subscribed to the foregoing instrument, appeared before me this day in person and being first duly sworn by me acknowledged that as such President, he signed and delivered the said instrument, pursuant to authority given by Livent Realty (Chicago) Inc., as his free and voluntary act and as the free and voluntary act of said corporation, for the uses and purposes therein set forth.

GIVEN under my hand and notarial seal this ____ day of _____, 1996.

Notary Public

(SEAL)

My Commission expires _____.

EXHIBIT H

COVENANT OF PERFORMANCE

This Covenant of Performance ("Covenant of Performance") is made this ____ day of _____, 1996 by Livent Realty (Chicago) Inc., a Delaware corporation ("Mortgagor"), to the City of Chicago, an Illinois municipal corporation ("City").

RECITALS

WHEREAS, the City Council of the City, by ordinance adopted March 26, 1996, authorized the execution by Mortgagor and the City of that certain "Block 36, North Loop Project Redevelopment Agreement, Oriental Theater" dated as of April __, 1996 ("Redevelopment Agreement"); and

WHEREAS, all capitalized terms, unless otherwise defined herein, shall have the meaning for them ascribed in the Redevelopment Agreement; and

WHEREAS, the Redevelopment Agreement provides inter alia for the assembling of certain real property on Block 36 constituting the Site (for purposes of this Covenant, the "Land") as legally described in Exhibit A attached hereto, and the development and construction of the Project improvements (for purposes of this Covenant, the "Improvements") on the Land (the Land and the Improvements are collectively referred to as the "Mortgaged Property"); and

WHEREAS, the Improvements were constructed by Mortgagor in part by utilizing the City's Financial Contribution in the aggregate amount of \$_____ to pay for certain eligible Redevelopment Project Costs, as are further described in the Redevelopment Agreement; and

WHEREAS, the City's Financial Contribution has been derived from Incremental Taxes allocated to the City in accordance with the TIF Plan and the TIF Ordinances, and any use of the City's Financial Contribution must be in accordance with any laws, regulations and ordinances governing the use of such funds, including, without limitation, the Illinois Tax Increment Allocation Redevelopment Act, 65 ILCS 5/11-74.4-3 et seq. (1994); and

WHEREAS, the utilization of the City's Financial Contribution to pay for certain Redevelopment Project Costs is in consideration for the performance by Mortgagor of certain obligations relating to the construction of the Improvements, and after the issuance of the Certificate by the City, of certain use and performance covenants until the expiration of the Term of the Agreement, and any sums of

the City's Financial Contribution may be recovered by the City only upon the terms and conditions set forth in the Covenant of Performance and/or the Mortgage (hereinafter defined) securing the same;

NOW, THEREFORE, in consideration of the benefits accruing to Mortgagor as a result of the Redevelopment Agreement, Mortgagor covenants to the City as follows:

1. It shall construct the Improvements in accordance with the terms and conditions of the Redevelopment Agreement.
2. After the issuance of the Certificate by the City until the expiration of the Term of the Agreement, Mortgagor shall perform and abide by those certain Use and Performance Covenants, as are more particularly described in subsection 7.2 of the Redevelopment Agreement.
3. If, from the execution date of the Covenant of Performance until the expiration of the Term of the Agreement ("Enforceability Period"), Mortgagor defaults with regard to the performance of its construction requirements or fails to comply with the Use and Performance Covenants, and after the expiration of any applicable cure period, the City shall be entitled to recapture, and Mortgagor shall be obligated to pay the City, an amount equal to the fully disbursed amount of the City's Financial Contribution.
4. The Covenant of Performance shall be secured by that certain mortgage of even date herewith ("Mortgage") made by Mortgagor in favor of the City, encumbering the Mortgaged Property, which, upon execution by the parties, shall be filed and recorded with the Office of Recorder of Deeds of Cook County, Illinois.
5. Provided that Mortgagor has complied fully with the terms of the Covenant of Performance and the Mortgage during the Enforceability Period, the City, within thirty (30) days of receipt of a written request from Mortgagor, shall issue a release of the Covenant of Performance.
6. Any payment of recapture sums as described in this Covenant of Performance to be made by Mortgagor to the City pursuant to the Covenant of Performance shall be made at the Office of the City Comptroller for the City of Chicago, Illinois, or at such other places designated by the City.
7. If any lawsuit is instituted by the City to recover any sums owed the City pursuant to the Covenant of Performance and/or the Mortgage, Mortgagor agrees to pay

- (h) all other agreements, instruments and documents executed in connection with the foregoing.

In addition to the foregoing, we have examined:

(a) the original or certified copies of Developer's and Guarantor's (i) Articles of Incorporation, as amended to date, (ii) qualifications to do business and certificates of good standing in all states in which the Developer is qualified to do business, including the state of Illinois, (iii) By-Laws, as amended to date, and (iv) records of all corporate proceedings relating to the Project; and

(b) such other documents, records and legal matters as we have deemed necessary or relevant for purposes of issuing the opinions hereinafter expressed.

In all such examinations, we have assumed the genuineness of all signatures (other than those on behalf of Guarantor and Developer), the authenticity of documents submitted to us as originals and conformity to the originals of all documents submitted to us as certified, conformed or photostatic copies.

Based on the foregoing, it is our opinion that:

1. Developer is a corporation duly organized, validly existing and in good standing under the laws of the state of Delaware, has full power and authority to own and lease its properties and to carry on its business as presently conducted, and is in good standing and duly qualified to do business as a foreign corporation under the laws of every state, including the State of Illinois, in which the conduct of its affairs or the ownership of its assets requires such qualification, except for those states in which its failure to qualify to do business would not have a material adverse effect on it or its business.

2. Guarantor is a corporation duly organized, validly existing and in good standing under the laws of the Province of Ontario, has full power and authority to own and lease its properties and to carry on its business as presently conducted, and is in good standing and duly qualified to do business as a foreign corporation under the laws of every state of the United States, including the State of Illinois, in which the conduct of its affairs or the ownership of its assets requires such qualification, except for those states in which its failure to qualify to do business would not have a material adverse effect on it or its business.

3. Developer or Guarantor, as the case may be, has full right, power and authority to execute and deliver the Documents to which it is a party and to perform its obligations thereunder. Such execution, delivery and performance will not conflict with, or result in a breach of, the Developer's or Guarantor's Articles of Incorporation or By-Laws or result in a breach or other violation

of any of the terms, conditions or provisions of any law or regulation, order, writ, injunction or decree of any court, government or regulatory authority, or, to the best of our knowledge after diligent inquiry, any of the terms, conditions or provisions of any agreement, instrument or document to which Developer or Guarantor is a party or by which Developer or Guarantor or its properties is bound. To the best of our knowledge after diligent inquiry, such execution, delivery and performance will not constitute grounds for acceleration of the maturity of any agreement, indenture, undertaking or other instrument to which Developer or Guarantor is a party or by which it or any of its property may be bound, or result in the creation or imposition of (or the obligation to create or impose) any lien, charge or encumbrance on, or security interest in, any of its property pursuant to the provisions of any of the foregoing, other than in favor of the Construction Lender, if any.

4. The execution and delivery of each Document and the performance of the transactions contemplated thereby have been duly authorized and approved by all requisite action on the part of Developer or Guarantor, as applicable.

5. Each of the Documents to which Developer or Guarantor is a party has been duly executed and delivered by a duly authorized officer of Developer or Guarantor, and each such Document constitutes the legal, valid and binding obligation of Developer or Guarantor, enforceable in accordance with its terms, except as limited by applicable bankruptcy, reorganization, insolvency or similar laws affecting the enforcement of creditors' rights generally.

6. To the best of our knowledge after diligent inquiry, no judgments are outstanding against Developer or Guarantor, nor is there now pending or threatened, any litigation, contested claim or governmental proceeding by or against Developer or Guarantor or affecting Developer or Guarantor or its property, or seeking to restrain or enjoin the performance by Developer of the Agreement, or by Guarantor under the Guaranty, or the transactions contemplated by the Agreement, or contesting the validity thereof. To the best of our knowledge after diligent inquiry, Developer or Guarantor is not in default with respect to any order, writ, injunction or decree of any court, government or regulatory authority or in default in any respect under any law, order, regulation or demand of any governmental agency or instrumentality, a default under which would have a material adverse effect on Developer or Guarantor or its business.

7. To the best of our knowledge after diligent inquiry, there is no default by Developer or Guarantor or any other party under any material contract, lease, agreement, instrument or commitment to which Developer or Guarantor is a party or by which the company or its properties is bound.

8. To the best of our knowledge after diligent inquiry, all of the assets of Developer are free and clear of mortgages, liens, pledges, security interests and encumbrances except for those specifically set forth in the Documents.

9. The execution, delivery and performance of the Documents by Developer or Guarantor have not and will not require the consent of any person or the giving of notice to, any exemption by, any registration, declaration or filing with or any taking of, any other actions in respect of, any person, including without limitation any court, government or regulatory authority.

10. To the best of our knowledge after diligent inquiry, Developer owns or possesses or is licensed or otherwise has the right to use all licenses, permits and other governmental approvals and authorizations, operating authorities, certificates of public convenience, goods carriers permits, authorizations and other rights that are necessary for the operation of its business.

11. A federal or state court sitting in the State of Illinois and applying the choice of law provisions of the State of Illinois would enforce the choice of law contained in the Documents and apply the law of the State of Illinois to the transactions evidenced thereby.

We have received an opinion from local counsel as to federal laws of the United States of America and the laws of the State of Illinois in conjunction with this transaction, and are providing a copy thereof to the City.

This opinion is issued at Developer's request for the benefit of the City, its counsel and may not be disclosed to or relied upon by any other person.

Yours very truly,

Rodney W.J. Seyffert
Smith Lyons
Barristers & Solicitors

all of the City's costs incurred as a result of such collection, including reasonable attorney's fees and court costs.

8. Demand, protest and notice of demand and protest are hereby waived.
9. This Covenant of Performance is submitted to the City at City Hall in the City of Chicago, State of Illinois, and shall be deemed to have been made thereat. This Covenant of Performance shall be governed and controlled as to interpretation, enforcement, validity, construction, effect and in all other respects by the laws, statutes and decisions of the State of Illinois. Mortgagor, in order to induce the City to accept this Covenant of Performance, and for other good and valuable consideration, the receipt and sufficiency of which are hereby acknowledged, agrees that all actions or proceedings arising directly, indirectly or otherwise in connection with, out of, related to or from this Covenant of Performance shall be litigated, at the City's sole discretion and election, only in courts having a situs within the County of Cook, State of Illinois. Mortgagor hereby consents and submits to the jurisdiction of any local, state or federal court located within said county and state. To the extent permitted by law, Mortgagor hereby knowingly, voluntarily and intentionally waives the right it may have to a trial by jury in any litigation based hereon, or arising out of, under or in connection with this Covenant of Performance and any agreement contemplated to be executed in conjunction herewith. This provision is a material inducement for the City to enter into the Redevelopment Agreement with Mortgagor.

IN WITNESS WHEREOF, the Covenant of Performance has been duly executed by Mortgagor, as of the date above written.

LIVENT REALTY (CHICAGO) INC.,
a Delaware corporation

By: _____
Garth H. Drabinsky
Chairman

By: _____
Myron I. Gottlieb
President

EXHIBIT I

OPINION OF DEVELOPER'S COUNSEL

[To be retyped on Developer's Counsel's letterhead]

_____, 1996

City of Chicago
121 North LaSalle Street
Room 511
Chicago, Illinois 60602

ATTENTION: Corporation Counsel

Ladies and Gentlemen:

We have acted as counsel to Livent Realty (Chicago), Inc., a Delaware corporation ("Developer"), in connection with the purchase of certain land and the construction of certain facilities thereon located in the North Loop Tax Increment Redevelopment Project Area ("Project"), and as counsel to Livent Inc., an Ontario, Canada corporation ("Guarantor"), being the parent company of Developer. In that capacity, we have examined, among other things, the following agreements, instruments and documents of even date herewith, hereinafter referred to as the "Documents":

- (a) Block 36, North Loop Project Redevelopment Agreement, Oriental Theater ("Agreement") executed by Developer and the City of Chicago ("City") as of April _____, 1996;
- (b) Completion Guaranty from Guarantor in favor of the City and dated as of April _____, 1996 ("Guaranty");
- (c) Escrow Agreement # _____ of even date herewith executed by Developer, the City and Chicago Title and Trust Company, as Escrowee;
- (d) Mortgage from Developer in favor of the City dated as of _____, 1996;
- (e) Covenant of Performance from Developer to the City dated as of _____, 1996;
- (f) Public Benefits Agreement executed by Developer and the City as of April _____, 1996;
- (g) Agreement to Provide Assistance to the Chicago School Reform Board of Trustees executed by Developer and the City as of April _____, 1996; and

ARCHITECT'S CERTIFICATE FOR PAYMENT

In accordance with the Contract Documents, based on on-site observations and the data comprising the above application, the Architect certifies to the Owner that to the best of the Architect's knowledge, information and belief the Work has progressed as indicated, the quality of the Work is in accordance with the Contract Documents, and the Contractor is entitled to payment of the AMOUNT CERTIFIED.

AMOUNT CERTIFIED..... \$..

(Attach explanation if amount certified differs from the amount applied for ARCHITECT:

By: _____ Date: ..

This Certificate is not negotiable. The AMOUNT CERTIFIED is payable only to Contractor named herein. Issuance, payment and acceptance of payment are a prejudice to any rights of the Owner or Contractor under this Contract.

AIA DOCUMENT G702 • APPLICATION AND CERTIFICATE FOR PAYMENT • MAY 1981 (EDITION • AIA • © 1981)
1111 AMERICAN INSTITUTE OF ARCHITECTS, 1735 NEW YORK AVENUE, N.W., WASHINGTON, D.C. 20006

WARNING: Unlicensed photocopying violates U.S. copyright laws and is subject to legal prosecution.

EXHIBIT L

PUBLIC BENEFITS AGREEMENT

THIS PUBLIC BENEFITS AGREEMENT ("Agreement") is made and entered into as of the ___ day of April, 1996, by and between the CITY OF CHICAGO, an Illinois municipal corporation, having its principal office at City Hall, 121 North LaSalle Street, Chicago, Illinois 60602 ("City"), and LIVENT REALTY (CHICAGO) INC., a Delaware corporation, having its principal address at 165 Avenue Road, Suite 600, Toronto, Ontario, Canada M5R 3S4 ("Developer").

W I T N E S S E T H :

WHEREAS, the City and Developer have executed that certain Redevelopment Agreement dated April ___, 1996 ("Redevelopment Agreement") relating to the acquisition of the Oliver Property and Oriental Property for the purpose of developing the Project that will include renovating and expanding into the Oliver Property the now closed theater at the Oriental Property that will become the new Oriental Theater and constructing other retail improvements at the Site; and

WHEREAS, all capitalized terms in this Agreement, unless otherwise defined herein, shall have the meanings ascribed for them in the Redevelopment Agreement; and

WHEREAS, in consideration of the City entering into the Redevelopment Agreement and providing the City's Financial Contribution towards the cost of the Project, and as required in the Redevelopment Agreement, Developer has agreed to provide to the City certain public benefits, all as described more fully below:

NOW THEREFORE, in consideration of the foregoing preambles, each of which is made a contractual part hereof, and of the mutual covenants and agreements contained herein and in the Redevelopment Agreement, the parties agree as follows:

1. Public Benefits Program. Developer shall provide, as public benefits to the City, the cash, cash equivalent and in-kind contributions, services, programs and benefits set forth in Schedule 1 attached hereto and incorporated herein by this reference ("Public Benefits Program"). The Public Benefits Program is primarily intended to be derived from the ownership and operation of the Oriental Theater by Developer, but also to include broader contributions predicated upon the general expertise of Developer and its affiliates in producing live theater entertainment and developing and managing live theater venues for that purpose. Developer's commitment and agreement to provide the Public Benefits Program shall last for the Term of the Agreement, being the period from the date hereof through and including March 1, 2007.

2. Reporting. Semi-annually during the first week of January and the first week of July of each year during the Term of the Agreement, Developer shall submit a general activity report for the Public Benefits Program covering the preceding semi-annual period and, to the extent feasible and foreseeable, projecting activities anticipated to occur for the upcoming semi-annual period with respect to the Public Benefits Program. Such reports shall be addressed and submitted to the Department of Planning and Development of the City (to the attention of the City's Commissioner of Planning and Development) at the address therefor set forth in Paragraph 4 below.

3. Default. Failure of Developer to comply with the terms and conditions of this Agreement, which failure continues uncured for a period of sixty (60) days after written notice of default from the City, shall be a default hereunder and shall be considered an Event of Default under the Redevelopment Agreement.

4. Notice. Any notice or submission required or desired to be given pursuant to or in connection with this Agreement shall be in writing and shall be mailed postage prepaid by registered or certified mail with return receipt requested, or hand delivered and receipted, as follows:

If to the City: City of Chicago
 Department of Planning and
 Development
 Room 1000, City Hall
 121 N. LaSalle Street
 Chicago, Illinois 60602
 Attn: Commissioner

If to Developer: Livent Realty (Chicago) Inc.
 Suite 600
 165 Avenue Road
 Toronto, Ontario
 Canada M5R 3S4
 Attn: President

Notices and submissions are deemed to have been received by the parties three (3) days after mailing. The parties, by notice given hereunder, may designate any further or different addresses to which subsequent notices, submissions or other communications shall be sent.

5. Headings. The headings of the various Paragraphs of this Agreement have been inserted for convenient reference only and shall not in any manner be construed as modifying, amending or affecting in any way the express terms and provisions hereof.

6. Governing Law. This Agreement shall be governed by and construed in accordance with the laws of the State of Illinois.

7. Entire Agreement. This Agreement shall constitute the entire agreement of the parties regarding the subject matter hereof. This Agreement may not be modified or amended in any manner other than by written agreement executed by the parties.

8. Severability. If any provision of this Agreement, or any paragraph, sentence, clause, phrase or word or the application thereof is held invalid, the remainder of this Agreement shall be construed as if such invalid part were never included and this Agreement shall be and remain valid and enforceable to the fullest extent permitted by law.

9. Waiver and Estoppel. Any delay by the City in instituting or prosecuting any actions or proceedings or otherwise asserting its rights and remedies shall not operate as a waiver of such rights or remedies or operate to deprive the City of or limit such rights in any way. No waiver by the City with respect to any specific default by Developer shall be construed, considered or treated as a waiver of the rights of the City with respect to any other defaults of Developer.

10. Cumulative Remedies. The City may exercise all remedies provided by law or in equity in the event of a default hereunder. All remedies shall be cumulative and the exercise of any one or more remedies shall not be construed as a waiver of any other remedies.

11. Disclaimer. No provision of this Agreement, nor any act of the City, shall be deemed or construed by Developer, or by any third persons, to create any relationship of third-party beneficiary, or of principal or agent, or of limited or general partnership, or of joint venture, or of any association or relationship involving the City.

12. Binding Effect. This Agreement shall be binding on the parties hereto, their successors and assigns.

13. Term. The term hereof shall be for the Term of the Agreement. However, the term may be amended and extended by written agreement of the parties.

14. Counterparts. This Agreement may be executed in one or more counterparts, each of which shall be deemed an original and all of which shall constitute one and the same Agreement.

IN WITNESS WHEREOF, the parties hereto have executed or caused
his Agreement to be executed, all as of the date first written
above.

LIVENT REALTY (CHICAGO) INC.,
a Delaware corporation

By: _____
Garth H. Drabinsky
Chairman

By: _____
Myron I. Gottlieb
President

CITY OF CHICAGO,
an Illinois municipal corporation

By: _____
J.F. Boyle, Jr.
Commissioner of Planning
and Development

SCHEDULE 1

(Public Benefits Program)

During the Term of the Agreement:

- A. Developer shall provide complimentary tickets to performances open to the general public at the Oriental Theater. The complimentary tickets shall be made available for various public purposes such as to provide a cultural experience that would not otherwise be affordable for economically disadvantaged families and persons. The number of tickets to be provided by Developer is intended to be at least 200 tickets per year for performances and seat allocations selected by Developer in its sole discretion. Tickets shall be distributed to eligible recipients by Developer in coordination with representatives and officials of the City's Department of Human Services or not-for-profit agencies located in Chicago. The identity of the representatives of such agencies is to be agreed upon by the parties. Some or all of the tickets to be made available by Developer may be for "rush" seats and available at or near the time of performance.
- B. Developer shall provide use of the auditorium, or other suitable area for smaller festivities, of the Oriental Theater for various civic and community events for up to four (4) days per calendar year (prorated for less than a full calendar year). The arrangements for any such use shall be coordinated through the City's Department of Cultural Affairs and all requests of Developer for the use of such space shall be made in writing at least four (4) months prior to the proposed date when the space is to be utilized. The approval by Developer to the use of such space shall not be unreasonably withheld or delayed if the auditorium is available (it being acknowledged that the auditorium may not be available due to conflict with performances, rehearsals or load-in and load-outs of shows and other events at the theater), the civic and community event will not interfere with show sets and other props on stage and the user agrees to comply with Developer's customary terms for usage of the auditorium. Developer agrees that no rental will be charged with the view of making a profit for such usage for the aforesaid limited number of days per year but Developer shall be reimbursed its costs directly related to such usage that Developer would not otherwise incur but for such usage including, without limiting the generality of the foregoing, Developer's costs for providing all or any of set-up, security, ushering, backstage services, and clean-up. Developer shall provide the user an estimate of the costs to be incurred for the particular usage of the auditorium at the time of booking and may require a deposit or installments to secure the booking. Following the event, Developer shall be

Reimbursed for all costs not previously paid within fifteen (15) days of submission of an invoice and details of all of Developer's costs. At Developer's option and with user's concurrence, Developer may quote a fixed fee to cover its estimated costs.

EXHIBIT L

PUBLIC BENEFITS AGREEMENT

THIS PUBLIC BENEFITS AGREEMENT ("Agreement") is made and entered into as of the 24 day of April, 1996, by and between the CITY OF CHICAGO, an Illinois municipal corporation, having its principal office at City Hall, 121 North LaSalle Street, Chicago, Illinois 60602 ("City"), and LIVENT REALTY (CHICAGO) INC., a Delaware corporation, having its principal address at 165 Avenue Road, Suite 600, Toronto, Ontario, Canada M5R 3S4 ("Developer").

W I T N E S S E T H :

WHEREAS, the City and Developer have executed that certain Redevelopment Agreement dated April 24, 1996 ("Redevelopment Agreement") relating to the acquisition of the Oliver Property and Oriental Property for the purpose of developing the Project that will include renovating and expanding into the Oliver Property the now closed theater at the Oriental Property that will become the new Oriental Theater and constructing other retail improvements at the Site; and

WHEREAS, all capitalized terms in this Agreement, unless otherwise defined herein, shall have the meanings ascribed for them in the Redevelopment Agreement; and

WHEREAS, in consideration of the City entering into the Redevelopment Agreement and providing the City's Financial Contribution towards the cost of the Project, and as required in the Redevelopment Agreement, Developer has agreed to provide to the City certain public benefits, all as described more fully below:

NOW THEREFORE, in consideration of the foregoing preambles, each of which is made a contractual part hereof, and of the mutual covenants and agreements contained herein and in the Redevelopment Agreement, the parties agree as follows:

1. Public Benefits Program. Developer shall provide, as public benefits to the City, the cash, cash equivalent and in-kind contributions, services, programs and benefits set forth in Schedule 1 attached hereto and incorporated herein by this reference ("Public Benefits Program"). The Public Benefits Program is primarily intended to be derived from the ownership and operation of the Oriental Theater by Developer, but also to include broader contributions predicated upon the general expertise of Developer and its affiliates in producing live theater entertainment and developing and managing live theater venues for that purpose. Developer's commitment and agreement to provide the Public Benefits Program shall last for the Term of the Agreement, being the period from the date hereof through and including March 1, 2007.

2. Reporting. Semi-annually during the first week of January and the first week of July of each year during the Term of the Agreement, Developer shall submit a general activity report for the Public Benefits Program covering the preceding semi-annual period and, to the extent feasible and foreseeable, projecting activities anticipated to occur for the upcoming semi-annual period with respect to the Public Benefits Program. Such reports shall be addressed and submitted to the Department of Planning and Development of the City (to the attention of the City's Commissioner of Planning and Development) at the address therefor set forth in Paragraph 4 below.

3. Default. Failure of Developer to comply with the terms and conditions of this Agreement, which failure continues uncured for a period of sixty (60) days after written notice of default from the City, shall be a default hereunder and shall be considered an Event of Default under the Redevelopment Agreement.

4. Notice. Any notice or submission required or desired to be given pursuant to or in connection with this Agreement shall be in writing and shall be mailed postage prepaid by registered or certified mail with return receipt requested, or hand delivered and receipted, as follows:

If to the City: City of Chicago
 Department of Planning and
 Development
 Room 1000, City Hall
 121 N. LaSalle Street
 Chicago, Illinois 60602
 Attn: Commissioner

If to Developer: Livent Realty (Chicago) Inc.
 Suite 600
 165 Avenue Road
 Toronto, Ontario
 Canada M5R 3S4
 Attn: President

Notices and submissions are deemed to have been received by the parties three (3) days after mailing. The parties, by notice given hereunder, may designate any further or different addresses to which subsequent notices, submissions or other communications shall be sent.

5. Headings. The headings of the various Paragraphs of this Agreement have been inserted for convenient reference only and shall not in any manner be construed as modifying, amending or affecting in any way the express terms and provisions hereof.

6. Governing Law. This Agreement shall be governed by and construed in accordance with the laws of the State of Illinois.

7. Entire Agreement. This Agreement shall constitute the entire agreement of the parties regarding the subject matter hereof. This Agreement may not be modified or amended in any manner other than by written agreement executed by the parties.

8. Severability. If any provision of this Agreement, or any paragraph, sentence, clause, phrase or word or the application thereof is held invalid, the remainder of this Agreement shall be construed as if such invalid part were never included and this Agreement shall be and remain valid and enforceable to the fullest extent permitted by law.

9. Waiver and Estoppel. Any delay by the City in instituting or prosecuting any actions or proceedings or otherwise asserting its rights and remedies shall not operate as a waiver of such rights or remedies or operate to deprive the City of or limit such rights in any way. No waiver by the City with respect to any specific default by Developer shall be construed, considered or treated as a waiver of the rights of the City with respect to any other defaults of Developer.

10. Cumulative Remedies. The City may exercise all remedies provided by law or in equity in the event of a default hereunder. All remedies shall be cumulative and the exercise of any one or more remedies shall not be construed as a waiver of any other remedies.

11. Disclaimer. No provision of this Agreement, nor any act of the City, shall be deemed or construed by Developer, or by any third persons, to create any relationship of third-party beneficiary, or of principal or agent, or of limited or general partnership, or of joint venture, or of any association or relationship involving the City.

12. Binding Effect. This Agreement shall be binding on the parties hereto, their successors and assigns.

13. Term. The term hereof shall be for the Term of the Agreement. However, the term may be amended and extended by written agreement of the parties.

14. Counterparts. This Agreement may be executed in one or more counterparts, each of which shall be deemed an original and all of which shall constitute one and the same Agreement.

IN WITNESS WHEREOF, the parties hereto have executed or caused this Agreement to be executed, all as of the date first written above.

LIVENT REALTY (CHICAGO) INC.,
a Delaware corporation

By: 

Garth H. Drabinsky
Chairman

By: 

Myron I. Gottlieb
President

CITY OF CHICAGO,
an Illinois municipal corporation

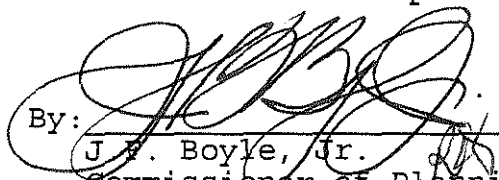
By: 

J. F. Boyle, Jr.
Commissioner of Planning
and Development

SCHEDULE 1

(Public Benefits Program)

During the Term of the Agreement:

- A. Developer shall provide complimentary tickets to performances open to the general public at the Oriental Theater. The complimentary tickets shall be made available for various public purposes such as to provide a cultural experience that would not otherwise be affordable for economically disadvantaged families and persons. The number of tickets to be provided by Developer is intended to be at least 200 tickets per year for performances and seat allocations selected by Developer in its sole discretion. Tickets shall be distributed to eligible recipients by Developer in coordination with representatives and officials of the City's Department of Human Services or not-for-profit agencies located in Chicago. The identity of the representatives of such agencies is to be agreed upon by the parties. Some or all of the tickets to be made available by Developer may be for "rush" seats and available at or near the time of performance.
- B. Developer shall provide use of the auditorium, or other suitable area for smaller festivities, of the Oriental Theater for various civic and community events for up to four (4) days per calendar year (prorated for less than a full calendar year). The arrangements for any such use shall be coordinated through the City's Department of Cultural Affairs and all requests of Developer for the use of such space shall be made in writing at least four (4) months prior to the proposed date when the space is to be utilized. The approval by Developer to the use of such space shall not be unreasonably withheld or delayed if the auditorium is available (it being acknowledged that the auditorium may not be available due to conflict with performances, rehearsals or load-in and load-outs of shows and other events at the theater), the civic and community event will not interfere with show sets and other props on stage and the user agrees to comply with Developer's customary terms for usage of the auditorium. Developer agrees that no rental will be charged with the view of making a profit for such usage for the aforesaid limited number of days per year but Developer shall be reimbursed its costs directly related to such usage that Developer would not otherwise incur but for such usage including, without limiting the generality of the foregoing, Developer's costs for providing all or any of set-up, security, ushering, backstage services, and clean-up. Developer shall provide the user an estimate of the costs to be incurred for the particular usage of the auditorium at the time of booking and may require a deposit or installments to secure the booking. Following the event, Developer shall be

reimbursed for all costs not previously paid within fifteen (15) days of submission of an invoice and details of all of Developer's costs. At Developer's option and with user's concurrence, Developer may quote a fixed fee to cover its estimated costs.

EXHIBIT M

AGREEMENT TO PROVIDE ASSISTANCE TO
THE CHICAGO SCHOOL REFORM BOARD OF TRUSTEES

THIS AGREEMENT TO PROVIDE ASSISTANCE TO THE CHICAGO SCHOOL REFORM BOARD OF TRUSTEES ("Agreement") is made and entered into as of the ___ day of April, 1996, by and between the CITY OF CHICAGO, an Illinois municipal corporation, having its principal office at City Hall, 121 North LaSalle Street, Chicago, Illinois 60602 (the "City"), and LIVENT REALTY (CHICAGO) INC., a Delaware corporation, having its principal address at 165 Avenue Road, Suite 600, Toronto, Ontario, Canada M5R 3S4 ("Developer").

W I T N E S S E T H :

WHEREAS, the City and Developer have executed that certain Redevelopment Agreement dated April __, 1996 ("Redevelopment Agreement") relating to the acquisition of the Oliver Property and Oriental Property for the purpose of developing the Project that will include renovating and expanding into the Oliver Property the now closed theater at the Oriental Property that will become the new Oriental Theater and constructing other retail improvements at the Site; and

WHEREAS, all capitalized terms in this Agreement, unless otherwise defined herein, shall have the meanings ascribed for them in the Redevelopment Agreement; and

WHEREAS, in consideration of the City entering into the Redevelopment Agreement and providing the City's Financial Contribution towards the cost of the Project, and as required in the Redevelopment Agreement, Developer has agreed to provide assistance to the Chicago School Reform Board of Trustees ("School Reform Board") and various services, opportunities and programs benefitting the students of the City's public schools in general and sponsored public schools in particular, all as described more fully below:

NOW THEREFORE, in consideration of the foregoing preambles, each of which is made a contractual part hereof, and of the mutual covenants and agreements contained herein and in the Redevelopment Agreement, the parties agree as follows:

1. School Assistance Program. Developer shall provide, as assistance to the School Reform Board and benefits to the City's public schools and the students thereof, the cash, cash equivalent and in-kind contributions, services, programs and benefits set forth in Schedule 1 attached hereto and incorporated herein by this reference ("School Assistance Program"). The School Assistance Program is primarily intended to be derived from the ownership and operation of the Oriental Theater by Developer, but also to include broader contributions predicated upon sponsoring a public school as a school of performing arts by virtue of the general expertise of

Developer and its affiliates in producing live theater entertainment. Developer's commitment and agreement to provide the School Assistance Program shall last for the Term of the Agreement, being the period from the date hereof through and including March 1, 2007.

2. Reporting. Semi-annually during the first week of January and the first week of July of each year during the Term of the Agreement, Developer shall submit a general activity report for the School Assistance Program covering the preceding semi-annual period and, to the extent feasible and foreseeable, projecting activities anticipated to occur for the upcoming semi-annual period with respect to the School Assistance Program. Such reports shall be addressed and submitted to the Department of Planning and Development of the City (to the attention of the City's Commissioner of Planning and Development) with a copy to the School Reform Board (to the attention of its President), in each case at the address therefor set forth in Paragraph 4 below.

3. Default. Failure of Developer to comply with the terms and conditions of this Agreement, which failure continues uncured for a period of sixty (60) days after written notice of default from the City, shall be a default hereunder and shall be considered an Event of Default under the Redevelopment Agreement.

4. Notice. Any notice or submission required or desired to be given pursuant to or in connection with this Agreement shall be in writing and shall be mailed postage prepaid by registered or certified mail with return receipt requested, or hand delivered and receipted, as follows:

If to the City: City of Chicago
 Department of Planning and
 Development
 Room 1000, City Hall
 121 N. LaSalle Street
 Chicago, Illinois 60602
 Attn: Commissioner

with a copy to: Chicago School Reform Board
 of Trustees
 1819 West Pershing Road
 6 East (North)
 Chicago, Illinois 60609
 Attn: President

If to Developer: Livent Realty (Chicago) Inc.
 165 Avenue Road, Suite 600
 Toronto, Ontario
 Canada M5R 3S4
 Attn: President

Notices and the parties there given hereunder, to which subsequent shall be sent.

5. Head Agreement shall not affecting in a

6. Gove construed in

7. Ent entire agreement hereof. This manner other

8. se paragraph, thereof is construed a Agreement shall extent pem

9. in institutio asserting such right such right specific treated a other de

10. provided All remed more remed remedies

11. of the third benefici School school limited associat

12. Parties

Notices and submissions are deemed to have been received by the parties three (3) days after mailing. The parties, by notice given hereunder, may designate any further or different addresses to which subsequent notices, submissions or other communications shall be sent.

5. Headings. The headings of the various Paragraphs of this Agreement have been inserted for convenient reference only and shall not in any manner be construed as modifying, amending or affecting in any way the express terms and provisions hereof.

6. Governing Law. This Agreement shall be governed by and construed in accordance with the laws of the State of Illinois.

7. Entire Agreement. This Agreement shall constitute the entire agreement of the parties regarding the subject matter hereof. This Agreement may not be modified or amended in any manner other than by written agreement executed by the parties.

8. Severability. If any provision of this Agreement, or any paragraph, sentence, clause, phrase or word or the application thereof is held invalid, the remainder of this Agreement shall be construed as if such invalid part were never included and this Agreement shall be and remain valid and enforceable to the fullest extent permitted by law.

9. Waiver and Estoppel. Any delay by the City in instituting or prosecuting any actions or proceedings or otherwise asserting its rights and remedies shall not operate as a waiver of such rights or remedies or operate to deprive the City of or limit such rights in any way. No waiver by the City with respect to any specific default by Developer shall be construed, considered or treated as a waiver of the rights of the City with respect to any other defaults of Developer.

10. Cumulative Remedies. The City may exercise all remedies provided by law or in equity in the event of a default hereunder. All remedies shall be cumulative and the exercise of any one or more remedies shall not be construed as a waiver of any other remedies.

11. Disclaimer. No provision of this Agreement, nor any act of the City, shall be deemed or construed by Developer, or by any third persons, to create any relationship of third-party beneficiary (except for the express benefits intended for the School Reform Board in the sponsorship of a public school as a school for the performing arts), or of principal or agent, or of limited or general partnership, or of joint venture, or of any association or relationship involving the City.

12. Binding Effect. This Agreement shall be binding on the parties hereto, their successors and assigns.

13. Term. The term hereof shall be for the Term of the Agreement. However, the term may be amended and extended by written agreement of the parties.

14. Counterparts. This Agreement may be executed in one or more counterparts, each of which shall be deemed an original and all of which shall constitute one and the same Agreement.

IN WITNESS WHEREOF, the parties hereto have executed or caused this Agreement to be executed, all as of the date first written above.

LIVENT REALTY (CHICAGO) INC.,
a Delaware corporation

By: _____
Garth H. Drabinsky
Chairman

By: _____
Myron I. Gottlieb
President

CITY OF CHICAGO,
an Illinois municipal corporation

BY: _____
J.F. Boyle, Jr.
Commissioner of Planning
and Development

SCHEDULE 1

(School Assistance Program)

During the Term of the Agreement:

- A. Developer (sometimes referred to as Livent), once the Oriental Theater is redeveloped and open for business, agrees to provide educational programs substantially along the lines of those described in general in Exhibit A attached hereto and incorporated herein by this reference, as such programs may be expanded, replaced or altered from time to time but always with the view of providing worthwhile and educational benefits to the students of the City's public schools and their educators ("General Education Program"). The General Education Program is intended to provide on average annual monetary and in-kind benefits of at least \$50,000.00, as adjusted bi-annually for inflation. As the General Education Program is made more specific from time to time with respect to a particular production at the Oriental Theater, such information shall be made available in a timely manner to the School Reform Board. The General Education Program, as part of the School Assistance Program, shall be coordinated by Developer with the proper officials of the School Reform Board with the view of providing a fair distribution of benefits throughout the entire City public school system.

- B. As part of the School Assistance Program, Developer shall sponsor a public school designated from time to time as a school for performing arts by the School Reform Board because of special programs being offered, or to be offered, at such school beyond those normally provided to make available specialized training and education in the performing arts, including music, song and acting that are integral to live theater. Such sponsorship shall include workshops, guest lecturing and financial sponsorship in an amount not to exceed \$10,000.00 per school year, as adjusted bi-annually for inflation ("Sponsorship Program"). The broad outline of the Sponsorship Program contained herein is subject to refinement through negotiation and coordination conducted in good faith between Developer and the School Reform Board (or designee thereof).

ORIENTAL - NORTH LOOP

EXHIBIT **N + O**

ORIENTAL THEATER -159 N. DEARBORN (NORTH LOOP TIF)

TAX YEAR	MINIMUM ASS. VALUE	ESTIMATED MULTIPLIER	MINIMUM EAV	TAX RATE	TAXES
1995	\$1,300,834	2.1135	\$2,749,313	9%	\$247,438
1996	\$1,300,834	2.1135	\$2,749,313	9%	\$247,438
1997	\$1,380,455	2.1135	\$2,917,593	9%	\$262,583
1998	\$1,380,455	2.1135	\$2,917,593	9%	\$262,583
1999	\$1,380,455	2.1135	\$2,917,593	9%	\$262,583
2000	\$1,464,950	2.1135	\$3,096,173	9%	\$278,656
2001	\$1,464,950	2.1135	\$3,096,173	9%	\$278,656
2002	\$1,464,950	2.1135	\$3,096,173	9%	\$278,656
2003	\$1,554,617	2.1135	\$3,285,683	9%	\$295,711
2004	\$1,554,617	2.1135	\$3,285,683	9%	\$295,711
2005	\$1,554,617	2.1135	\$3,285,683	9%	\$295,711
2006	\$1,649,772	2.1135	\$3,486,793	9%	\$313,811
2007	\$1,649,772	2.1135	\$3,486,793	9%	\$313,811

EXHIBIT P

The Oliver Building Facade Oriental Theater Redevelopment Agreement

Facade, General

- ▶ The developer may not demolish the facade; increase or decrease its height (except as it relates to installing the historic cornice); or adversely affect its structural soundness.
- ▶ The developer must follow the building permit review procedures in accordance with the Chicago Landmarks Ordinance.
- ▶ The developer should conduct a qualified study of the existing condition of the facade's masonry surfaces and clean, point, or perform other repair work as recommended by the study. If during the course of the development project any damage should occur to these surfaces, the developer shall repair them in a way that respects the existing materials.
- ▶ The developer should remove all existing window air conditioners, modern signage, and the entrance canopy.
- ▶ The back wall of the theater visible from the building's exterior should be a uniform color.

Storefront

Storefront: the building's ground floors up to the secondary cornice line.

- ▶ The developer shall maintain the column spacing and historical ornamentation of the storefront and shall submit for review and approval the articulation of the storefronts within the bays. (DPD will provide drawings, and the developer will pay, as part of the project cost, any necessary duplication and shipment charges.) The actual plans will be reviewed as part of the permit review process.
- ▶ The developer should install theater-related displays behind the storefront windows. Current plans do not show any space allocated for the displays. Plans should be revised to show allocation of this space as well as design of the display cases and will be reviewed as part of the permit review process.
- ▶ The developer should, if possible, replicate and install the missing storefront-level ornamentation that once turned onto Couch Place. (DPD will provide drawings, and the developer will pay, as part of the project cost, any necessary duplication and shipment

charges.)

Roof/Cornice

- ▶ The developer should set back rooftop mechanical systems so that they are not visible from the sidewalk directly across from the Oliver Building on the west side of Dearborn Street.
- ▶ The developer should replicate and install the missing cornice. (DPD will provide drawings, and the developer will pay, as part of the project costs, any necessary duplication and shipment charges.)

Windows

- ▶ If windows above the storefront are replaced, they should use clear glass panes in their original dimensions and wooden frames.
- ▶ Window treatments will be reviewed as part of the plan review process.
- ▶ The developer should provide internal access to the windows so that they can be cleaned and maintained.
- ▶ Any proposed art or lighting installations in the windows above the storefront must be reviewed and approved by DPD, Landmarks Division.

EXHIBIT Q

April 2, 1996

COMPLETION GUARANTY

THIS COMPLETION GUARANTY ("Guaranty") is made and entered into as of the ___ day of _____, 1996 by LIVENT, INC., an Ontario, Canada corporation ("Guarantor"), to and for the benefit of the CITY OF CHICAGO, an Illinois municipal corporation (the "City").

WITNESSETH:

WHEREAS, Livent Realty (Chicago) Inc., a Delaware corporation ("Developer"), has entered into that certain Redevelopment Agreement with the City dated April __, 1996 (the "Redevelopment Agreement") regarding the redevelopment of the Property that is owned or to be owned by Developer as contemplated therein; and

WHEREAS, pursuant to the Redevelopment Agreement, Developer has undertaken to complete the Project at the combined Oriental Property and Oliver Property, which entails among other things the renovation and reconstruction of the Oriental Theater as the same will be expanded into the Oliver Building, being parts of the Property; and

WHEREAS, Developer is a wholly-owned subsidiary of Guarantor; and

WHEREAS, as a condition of entering into the Redevelopment Agreement, the City has required that Guarantor enter into this Guaranty to secure the Completion of the Project on the terms and conditions hereinafter set forth;

NOW, THEREFORE, in consideration of the foregoing premises, the mutual covenants and agreements contained herein and for other good and valuable consideration, including the City entering into the Redevelopment Agreement as induced by Guarantor providing this Guaranty, the receipt and sufficiency of which are hereby acknowledged, it is hereby agreed by Guarantor as follows:

1. Definitions. For the purposes of this Guaranty, all capitalized terms not otherwise defined shall have the same definitions and meanings as are contained in the Redevelopment Agreement.

2. The Guaranty. Subject to the terms and conditions hereof, Guarantor irrevocably and unconditionally undertakes and guarantees (a) the full and faithful performance of the obligations set forth in the Redevelopment Agreement on Developer's part to be kept and performed with respect to Completion of the Project, including without limiting the generality of the foregoing, the

obligation to cause the Project to be developed, reconstructed and constructed within applicable time limitations set forth in the Redevelopment Agreement in accordance with permit plans and specifications which have been developed based on design development plans and specifications reviewed and approved by the City pursuant to the Redevelopment Agreement (as such final plans and specifications may be modified, amended or supplemented from time to time pursuant to and in accordance with the Redevelopment Agreement), and in any event to cause Completion of the Project by the earlier of (a) twenty-four (24) months from the earlier of: (i) issuance of the building permit for excavation and/or foundation work and (ii) the later of the date by which vacant possession of the Oliver Building is delivered to Developer and the Oriental Property is acquired by Developer; or (b) June 30, 1998, subject to Permitted Delays (collectively, all such obligations are referred to herein as the "Construction Obligations"); and (b) the payment of all costs associated with Completion of the Project, all in accordance with the Redevelopment Agreement, including but not limited to, any and all increases to the Budget as approved from time to time by the City.

Upon Completion of the Project and fulfillment of all of the Construction Obligations and receipt from the City of the Certificate regarding Completion in accordance with Section 4.13 of the Redevelopment Agreement, all of the Construction Obligations undertaken by Guarantor and all the obligations of Guarantor to pay for or cause to be paid for Completion of the Project under this Guaranty shall be conclusively deemed to have been satisfied, except as qualified for amounts in respect of which there is a bona fide dispute until such dispute has been resolved or determined and all sums owed have been paid.

3. Construction Obligations of Guarantor. If (a) the Construction Obligations are not timely performed by Developer, or (b) the City takes possession of the Property prior to the Completion of the Project by reason of an "Event of Default", as defined under the Redevelopment Agreement, the Covenant of Performance or the Mortgage, or a refusal by Developer to continue performing the Construction Obligations, or (c) the City has the right to cease making or to refuse to make any further disbursements to Developer under the Redevelopment Agreement (any such nonperformance, taking of possession or refusal to make advances being herein sometimes called a "Default"), then, subject to the terms and conditions hereof, Guarantor unconditionally and irrevocably agrees:

- (i) within five (5) days after written demand by the City, to immediately assume full responsibility for the Completion of the Project under the same standards and other requirements as apply to Developer under the Redevelopment Agreement;

- (ii) at the cost and expense of Guarantor, to promptly and expeditiously perform the Construction Obligations in accordance with the provisions of the Redevelopment Agreement; provided that so long as (1) there is no default by Guarantor hereunder and (2) but for Developer's failure to fully and faithfully perform the Construction Obligations, all conditions of an Advance by the City under the Redevelopment Agreement are satisfied, the City, if in possession of the Property, shall surrender possession to Developer or as Guarantor may direct in writing and, from time to time as the Project progresses, shall make available to Guarantor so assuming the responsibility and obligations hereunder, any undisbursed amount in the City's Financial Contribution budgeted for purposes of Completion of the Project (but only in accordance with and limited by the applicable provisions in the Redevelopment Agreement regarding Advances), subject to performance by Guarantor of all Construction Obligations;
- (iii) to indemnify and hold the City harmless from any and all loss, cost, damage, liability or expense the City may suffer by reason of any Default described in clause (a) or clause (c) above; and
- (iv) to reimburse or repay the City fully and within five (5) days of written demand for all outlays and expenses that the City may incur or expend pursuant to Paragraph 4 of this Guaranty, including, without limitation, all outlays and expenses that the City may make or incur if the City, following a refusal to perform by Guarantor, in its sole discretion, elects to undertake Completion of the Project in substantial accordance with the terms of the Redevelopment Agreement, with such changes or modifications thereto as the City deems necessary and that do not materially adversely affect the design of the Project (except as otherwise permitted by the Redevelopment Agreement).

4. The City's Option to Complete the Project. At the time of any Default giving rise to Guarantor's liability hereunder, Guarantor may continue to retain the services of the Construction Manager serving at the time of the Default or may select a competent and experienced successor construction manager or general contractor acceptable to the City.

If and to the extent that the City elects to continue the Project following Guarantor's failure to commence and thereafter diligently perform its obligations under this Guaranty relating to the Completion of the Project and the other Construction Obligations within five (5) days after written demand, the City at its sole option, shall have the right to terminate the Construction

Manager's agreement and replace the Construction Manager with a successor construction manager or general contractor selected by the City in its sole judgment and to take such other actions it believes necessary for the Completion of the Project as provided for in this Guaranty (but with the further right to suspend or terminate such actions at any time) either before, during or after commencement of any foreclosure proceedings and before, during or after the pursuing of any other remedy of the City against Developer or Guarantor, and expend such sums as the City in its reasonable judgment determines to be necessary or appropriate for the Completion of the Project in accordance with any approved plans and specifications, as may be qualified by the provisions of this Guaranty. No such actions by the City will release or limit the liability of Guarantor hereunder. The amount of any and all expenditures for the Completion of the Project made by the City for the foregoing purposes in excess of the amounts allocated therefor under the Budget or the Redevelopment Agreement as part of the City's Financial Contribution shall be immediately due and payable to the City by Guarantor on demand of the City.

5. Representations and Warranties. The following shall constitute representations and warranties of Guarantor and Guarantor acknowledges that the City intends to enter into the Redevelopment Agreement in reliance thereon:

- (a) Guarantor is not in default and no event has occurred which with the passage of time and/or the giving of notice will constitute a default under any agreement to which Guarantor is a party, the effect of which will impair performance by Guarantor of its obligations pursuant to and as contemplated by the terms of this Guaranty, and neither the execution and delivery of this Guaranty nor compliance with the terms and provisions hereof will violate any presently existing provision of law or any presently existing regulation, order, writ, injunction or decree of any court or governmental department, commission, board, bureau, agency or instrumentality, or will conflict or will be inconsistent with, or will result in any breach of, any of the terms, covenants, conditions or provisions of, or constitute a default under, any indenture, mortgage, deed of trust, instrument, document, agreement or contract of any kind that creates, represents, evidences or provides for any lien, charge or encumbrance upon any of the property or assets of Guarantor, or any other indenture, mortgage, deed of trust, instrument, document, agreement or contract of any kind to which Guarantor is a party or by which Guarantor or any of its property may be subject, or in the event of any such conflict, the required consent or waiver of the other party or parties thereto has been

validly granted, is in full force and effect, is valid and sufficient therefor and has been approved by the City;

- (b) There are no actions, suits or proceedings pending or threatened against Guarantor before any court or any governmental, administrative, regulatory, adjudicatory or arbitrational body or agency of any kind that will adversely affect performance by Guarantor of its obligations pursuant to and as contemplated by the terms and provisions of this Guaranty; and
- (c) Neither this Guaranty nor any document, financial statement, credit information, certificate or statement heretofore furnished or required herein to be furnished to the City by Guarantor contains any untrue statement of material fact or omits to state a fact material to this Guaranty.

6. Certain Covenants. Guarantor agrees and covenants that:

- (a) Any indebtedness of Developer now or hereafter existing, together with any interest thereon, to Guarantor, and all rights of Guarantor to any fees, salaries or commissions due it or its affiliates from Developer whether current or accrued are hereby subordinated to any indebtedness of Developer to the City under any of the Redevelopment Agreement, Covenant of Performance or Mortgage (collectively the "Deal Documents"), and such indebtedness of Developer to Guarantor in the event of a default hereunder or the existence of an Event of Default under the Deal Documents shall be collected, enforced and received by Guarantor in trust for the benefit of the City and shall be paid over to the City on account of any indebtedness of Developer to the City but without impairing or affecting in any manner the liability of Guarantor under the other provisions of this Guaranty. So long as no Event of Default exists under the Deal Documents and no default has occurred hereunder, Guarantor may apply to its accounts, payments made to it by Developer on Developer's indebtedness held by or due to Guarantor;
- (b) Any lien, security interest or charge on the Property, the personal property located thereon, all rights therein and thereto, or on the revenue and income to be realized therefrom, which Guarantor may have or obtains as security for any loans, advances or costs in connection with the Property and the Completion of the Project shall be, and such lien, security interest or charge hereby is, subordinated to all liens and security interests heretofore, now or hereafter granted by Developer under

the Deal Documents; provided that the right of Developer to grant or permit any such lien, security interest or change on the Property shall remain governed by, and limited to the extent provided in, the Deal Documents;

- (c) The liability of Guarantor shall in no way be affected, diminished or released by any extension of time or forbearance that may be granted by the City to Developer or any waiver by the City under any of the Deal Documents or by reason of any change or modification in any of said instruments or by the acceptance by the City of additional security or any increase, substitution or changes therein, or by the release by the City of any security or any withdrawal thereof or decrease therein or by the failure or election not to pursue any remedies it may have against Developer or Guarantor;
- (d) The City, in its sole discretion, may at any time enter into agreement with Developer or Guarantor to amend and modify any one or more of the Deal Documents, and may waive or release any provision or provisions of any one or more thereof and, with reference thereto, may make and enter into any such agreement or agreements as the City, Developer or Guarantor may deem proper or desirable, without any notice to or further assent from Guarantor and without in any manner impairing or affecting this Guaranty or any of the City's rights hereunder;
- (e) The City may enforce this Guaranty without the necessity at any time of resorting to or exhausting any other remedy or any other security or collateral and without the necessity at any time of having recourse to any of the Deal Documents or the Property through foreclosure proceedings under the Mortgage or otherwise, and without the necessity of proceeding against Developer or Guarantor;
- (f) Nothing contained herein or otherwise shall prevent the City from pursuing concurrently or successively all rights and remedies available to it pursuant to any document or agreement in law or in equity and against any persons, firms or entities whatsoever (and particularly, but not by way of limitation, the City may sue on the Covenant of Performance, foreclose the Mortgage and exercise any other rights available to it under any one or more of the Deal Documents, including the Redevelopment Agreement or any other instrument of security), and the exercise of any of its rights or the completion of any of its remedies shall not constitute a discharge of any obligation of Guarantor hereunder, it

being the purpose of intent of Guarantor that its obligations shall be absolute, independent and unconditional under any and all circumstances whatsoever;

- (g) The liability of Guarantor hereunder or any remedy for the enforcement thereof shall in no way be affected by (i) the release or discharge of Developer in any creditors' receivership, bankruptcy or other proceedings, (ii) the impairment, limitation or modification of the liabilities of Developer to the City or the estate of Developer in bankruptcy, or of any remedy for the enforcement of Developer's said liability under any of the Deal Documents, resulting from the operation of any present or future provision of the Bankruptcy Reform Act, as amended, or other statute or from the decision in any court, (iii) the rejection or disaffirmance of any of the Deal Documents in any such proceedings, (iv) any right, claim or offset which Guarantor may have against Developer or (v) any defense, current or future, Guarantor may or might have to its undertakings, liabilities and obligations hereunder or to any action, suit or proceeding at law or otherwise, that may be instituted on this Guaranty; and
- (h) Guarantor shall be obligated to pay all reasonable attorneys' fees, court costs and expenses that may be incurred by the City in enforcing the obligations of Guarantor hereunder.

7. Waivers. Guarantor waives (i) notice of acceptance of this Guaranty by the City and any and all notices and demands of every kind that may be required to be given by any statute or rule or law, except as required by any Deal Document, (ii) any defense arising by reason of any disability or other defense of the Developer, (iii) presentment, demand, notice of dishonor, protest and all other notices whatsoever, (iv) any right to participate in any security now or later held by the City, (v) any right to enforce remedies the City now has, or later may have, against Developer and (vi) diligence in collection or protection of or realization upon any of the Construction Obligations, any other obligation hereunder, or any security for or guaranty of any of the foregoing, and any and all formalities that otherwise might be legally required to charge Guarantor with liability.

8. Effect of the City's Delay or Action. No delay on the part of the City in the exercise of any right or remedy shall operate as a waiver thereof, and no single or partial exercise by the City of any right or remedy shall preclude other or further exercise thereof or the exercise of any other right or remedy. No action of the City permitted hereunder shall in any way affect or impair the rights of the City and the obligation of Guarantor under this Guaranty.

9. Use of Funds. All amounts received by Developer from Guarantor pursuant to this Guaranty shall be used by Developer solely to pay costs to construct, reconstruct and complete the Project.

10. Agreements not Contingent. It is understood and acknowledged that the carrying out by Guarantor of the covenants and agreements made by it herein is not in any way contingent upon the carrying out by Developer or the City of any of their respective obligations or liabilities hereunder or under the Redevelopment Agreement or contained in any other instrument.

11. Frustration. It is the intention of Guarantor that, notwithstanding the occurrence or existence of any circumstance which but for this Paragraph might frustrate or be held to frustrate this Guaranty, the obligations and liabilities of Guarantor under this Guaranty shall continue in full force and effect as if such even or circumstance had not occurred or existed.

12. Continuing Obligations. The obligations of Guarantor hereunder are continuing obligations and a fresh cause of action shall be deemed to arise whenever and so often as Guarantor shall commit a breach of or be in default under any of its commitments or obligations hereunder. This Guaranty shall in all respects be a continuing, absolute and unconditioned guaranty, and shall remain in full force and effect until Completion of the Project.

13. Sale of Assets by Guarantor. Guarantor agrees that while this Guaranty is in force it will not sell its assets as an entirety or substantially as an entirety, unless, as a condition precedent to such sale, the transferee shall have agreed prior to or contemporaneously with its acquisition of such assets to assume the obligations and liabilities of Guarantor under this Guaranty in form approved by the City, acting reasonably, without, however, releasing Guarantor of or from such obligations or liabilities.

14. Financial Statements. Guarantor agrees to furnish to the City, within ninety (90) days after the end of its fiscal year, a balance sheet and an income statement, each prepared in reasonable detail and in accordance with generally accepted accounting principles applicable to Guarantor. In addition, Guarantor shall provide the City with such additional financial information as the City may reasonably require, but not more frequently than when Guarantor prepares its quarterly financial statements.

15. Time of Essence. Time is of the essence of this Guaranty.

16. Notices. Any notice, demand or request which may or is required to be given pursuant to this Guaranty shall be delivered to the parties at their respective addresses set forth below, and otherwise in accordance with the applicable provisions of Article 23 of the Redevelopment Agreement, which provisions are herein incorporated by reference:

(a) in the case of Guarantor:

Livent Inc.
Suite 600
165 Avenue Road
Toronto, Ontario
Canada M5R 3S4

Attn: Garth H. Drabinsky and Myron I. Gottlieb

with a copy to:

Smith Lyons
Barristers and Solicitors
Suite 5800, Scotia Place
40 King Street West
Toronto, Ontario
Canada M5H 3Z7

Attn: R.W.J. Seyffert, Esq.

(b) in the case of Developer:

Livent Realty (Chicago) Inc.
Suite 600
165 Avenue Road
Toronto, Ontario
Canada M5R 3S4

Attn: Garth H. Drabinsky and Myron I. Gottlieb

with a copy to:

Smith Lyons
Barristers and Solicitors
Suite 5800, Scotia Place
40 King Street West
Toronto, Ontario
Canada M5H 3Z7

Attn: R.W.J. Seyffert, Esq.

(c) in the case of the City:

The City of Chicago
Department of Planning and Development
City Hall, Room 1000
121 N. LaSalle Street
Chicago, Illinois 60602

Attn: Commissioner of Planning and Development

with a copy to:

The City of Chicago
Law Department
City Hall, Room 511
121 N. LaSalle St.
Chicago, Illinois 60602

Attn: Real Estate and Land Use Division

17. Modification. This Guaranty may not be modified, amended or, except as provided herein, terminated unless in writing and signed by the party or parties sought to be bound thereby.

18. Headings. The headings appearing before Paragraphs form no part of this Guaranty and shall be deemed to be inserted for convenience of reference only.

19. Severability. Whenever possible each provision of this Guaranty shall be interpreted in such manner as to be effective and valid under applicable law, but if any provision of this Guaranty shall be prohibited by or be invalid under such law, such provision shall be ineffective to the extent of such prohibition or invalidity, without invalidating the remainder of such provision or the remaining provisions of this Guaranty.

20. Successors and Assigns. This instrument shall inure to the benefit of the City, its successors and assigns, and shall bind Guarantor and its successors and assigns and shall survive the acquisition by the City of title to the Property by foreclosure, deed in lieu of foreclosure or the exercise of any similar remedy.

21. Governing Law. This Guaranty is submitted to the City at City Hall in the City of Chicago, State of Illinois, and shall be deemed to have been made thereat. This Guaranty shall be governed and controlled as to interpretation, enforcement, validity, construction, effect and in all other respects by the laws, statutes and decisions of the State of Illinois. Guarantor, in order to induce the City to accept this Guaranty, and for other good and valuable consideration, the receipt and sufficiency of which are hereby acknowledged, agrees that all actions or proceedings arising directly, indirectly or otherwise in connection

with, out of, related to or from this Guaranty shall be litigated, at the City's sole discretion and election, only in courts having a situs within the County of Cook, State of Illinois. Guarantor hereby consents and submits to the jurisdiction of any local, state or federal court located within said county and state. To the extent permitted by law, Guarantor hereby knowingly, voluntarily and intentionally waives the right it may have to a trial by jury in any litigation based hereon, or arising out of, under or in connection with this Guaranty and any agreement contemplated to be executed in conjunction herewith. This provision is a material inducement for the City to enter into the Redevelopment Agreement with Developer.

IN WITNESS WHEREOF, the undersigned Guarantor has duly executed this Guaranty as of the date first above written.

GUARANTOR:

LIVENT INC.

BY: 
_____, President

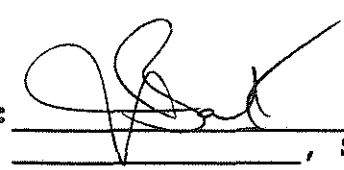
ATTEST: 
_____, Secretary

ORIENTAL THEATER PROJECT - OVERALL SCHEDULE

04/Apr/1996 - Oriental.tdb - Page: 3

2. Demolition / Structural	16/Aug/1996	4.00w	13/Sep/1996
3. MEP / Major Finishes	31/Jul/1996	1.00w	06/Aug/1996
4a. Balance Finishes	18/Sep/1996	1.00w	20/Sep/1996
4b. FFE / Theater Specialties	18/Sep/1996	1.00w	20/Sep/1996
TENDER	03/Jun/1996	18.60w	11/Oct/1996
1. Environmental Remediation	03/Jun/1996	2.00w	14/Jun/1996
2. Demolition / Structural	16/Aug/1996	4.00w	13/Sep/1996
3. MEP / Major Finishes	31/Jul/1996	4.00w	27/Aug/1996
4a. Balance Finishes	18/Sep/1996	4.00w	11/Oct/1996
4b. FFE / Theater Specialties	18/Sep/1996	4.00w	11/Oct/1996
NEGOTIATE, APPROVE & AWARD	17/Jun/1996	29.80w	08/Nov/1996
1. Environmental Remediation	17/Jun/1996	2.00w	28/Jun/1996
2. Demolition / Structural	13/Sep/1996	3.00w	03/Oct/1996
3. MEP / Major Finishes	28/Aug/1996	3.00w	18/Sep/1996
4a. Balance Finishes	14/Oct/1996	4.00w	08/Nov/1996
4b. FFE / Theater Specialties	14/Oct/1996	4.00w	08/Nov/1996
CONSTRUCTION	28/Aug/1996	19.37mon	21/Apr/1997
Environmental Remediation	28/Aug/1996	1.81mon	17/Oct/1996
Oriental Remediation	28/Aug/1996	1.00mon	18/Sep/1996
Other Building Remediation	01/Sep/1996	1.50mon	17/Oct/1996
Relocation of Existing Office MEP	28/Aug/1996	2.88mon	21/Oct/1996
Relocate Existing Office MEP	28/Aug/1996	2.00mon	21/Oct/1996
Demolition	04/Oct/1996	1.00mon	04/Nov/1996
Non-Structural Demolition	04/Oct/1996	1.00mon	04/Nov/1996
Theater Interior Demolition	04/Oct/1996	1.00mon	04/Nov/1996
Structural	04/Oct/1996	6.88mon	11/Apr/1997
Structural Demolition	04/Oct/1996	43.50d	08/Dec/1996
Excav / Shoring / Foundations	04/Oct/1996	43.50d	08/Dec/1996
Other Building Restructure	04/Oct/1996	138.50d	11/Apr/1997
Stage Wells	04/Oct/1996	43.50d	08/Dec/1996
Structural Steel	04/Oct/1996	130.50d	11/Apr/1997
Concrete	04/Oct/1996	130.50d	11/Apr/1997
Mechanical, Plumbing & Fire Protection	08/Dec/1996	14.92mon	23/Feb/1997
Mechanical	08/Dec/1996	304.94d	23/Feb/1997

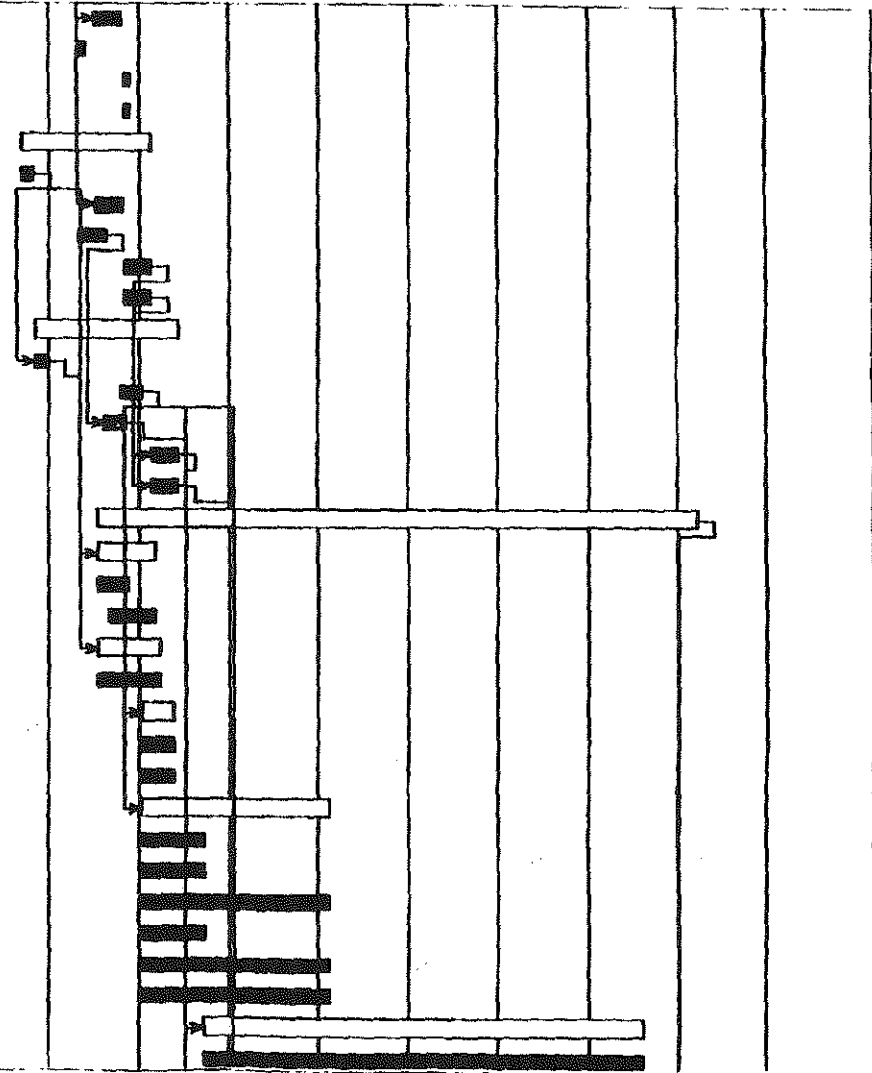

**ORIENTAL THEATER
PROJECT 94-368
EXHIBIT S
LIST OF COMPONENT WORK AND SPECIALTY WORK**

1.0 COMPONENT WORK

1.1 Environmental Remediation

- Hazardous material removal and remediation.

1.2 Relocation of Existing Office MEP

- Relocate existing office MEP.

1.3 Demolition Structural

- Non structural demolition.
- Theater interior demolition.
- Structural demolition.
- Excavation/shoring/foundations.
- Oliver Building restructure.
- Stage walls.
- Structural steel.
- Concrete.

1.4 MEP/Major Finishes

- Mechanical.
- Electrical.
- Plumbing.
- Fire Protection.
- Facades and windows.
- Roofing.
- Elevators.
- Interior masonry.
- Miscellaneous metal.