

FEBRUARY 15, 2019

ZONING BOARD OF APPEALS, CITY OF CHICAGO, CITY HALL, ROOM 905

APPLICANT: Grief Properties, Inc.

CAL NO.: 76-19-Z

APPEARANCE FOR: Rolando Acosta

MINUTES OF MEETING:
February 15, 2019

APPEARANCE AGAINST: None

PREMISES AFFECTED: 1638 N. Sedgwick Street

NATURE OF REQUEST: Application for a variation to reduce the front setback from the required 25.93' to 9.45', north from 2' to zero (south to be 3.33'), combined side setback from 4.80' to 3.33' for a proposed four-story, two dwelling unit building and an existing two car garage.

ACTION OF BOARD-

Continued to March 15, 2019 at 9:00 a.m.

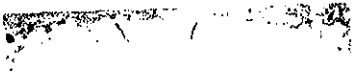

MAR 18 2019

**CITY OF CHICAGO
ZONING BOARD OF APPEALS**

SHAINA DOAR
SOL FLORES
SAM TOIA
AMANDA WILLIAMS

THE VOTE

AFFIRMATIVE	NEGATIVE	ABSENT
X		
X		
X		
X		

APPROVED AS TO SUBSTANCE

CHAIRMAN

ZONING BOARD OF APPEALS, CITY OF CHICAGO, CITY HALL, ROOM 905

APPLICANT: DeVry University, Inc.

CAL NO.:77-19-S

APPEARANCE FOR: Mara Georges

MINUTES OF MEETING:
February 15, 2019

APPEARANCE AGAINST: None

PREMISES AFFECTED: 1900-30 W. Lawrence Avenue

NATURE OF REQUEST: Application for a special use to establish a high school as part of a dual enrollment high school / university.

ACTION OF BOARD-
APPLICATION APPROVED

THE VOTE

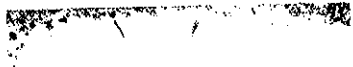

MAR 18 2019
CITY OF CHICAGO
ZONING BOARD OF APPEALS

SHAINA DOAR
SOL FLORES
SAM TOIA
AMANDA WILLIAMS

AFFIRMATIVE	NEGATIVE	ABSENT
X		
X		
X		
X		

THE RESOLUTION:

WHEREAS, a public hearing was held on this application by the Zoning Board of Appeals at its regular meeting held on February 15, 2019 after due notice thereof as provided under Section 17-13-0107B and by publication in the Chicago Sun-Times on January 4, 2019; and

WHEREAS, the Zoning Board of Appeals, having reviewed the proposed finding of fact and having fully heard the testimony and arguments of the parties and being fully advised in the premises, hereby finds the following; the applicant shall be permitted to establish a high school as part of a dual enrollment high school / university; expert testimony was offered that the use would not have a negative impact on the surrounding community and is in character with the neighborhood; further expert testimony was offered that the use complies with all of the criteria as set forth by the code for the granting of a special use at the subject site; the Board finds the use complies with all applicable standards of this Zoning Ordinance; is in the interest of the public convenience and will not have a significant adverse impact on the general welfare of neighborhood or community; is compatible with the character of the surrounding area in terms of site planning and building scale and project design; is compatible with the character of the surrounding area in terms of operating characteristics, such as hours of operation, outdoor lighting, noise, and traffic generation; and is designed to promote pedestrian safety and comfort; it is therefore

RESOLVED, that the aforesaid special use request be and it hereby is approved and the Zoning Administrator is authorized to permit said special use subject to the following condition(s): provided the special use is issued solely to the applicant DeVry University, Inc., and the development is consistent with the design and layout of the plans and drawings dated October 21, 2018, including the overall floor plan dated February 7, 2019, all prepared by ArchInteriors.

That all applicable ordinances of the City of Chicago shall be complied with before a permit is issued.

APPROVED AS TO SUBSTANCE
[Signature]
act CHAIRMAN

ZONING BOARD OF APPEALS, CITY OF CHICAGO, CITY HALL, ROOM 905

APPLICANT: Campbell General Construction, LLC **CAL NO.:** 78-19-Z

APPEARANCE FOR: Thomas Moore **MINUTES OF MEETING:**
February 15, 2019

APPEARANCE AGAINST: None

PREMISES AFFECTED: 10452 S. Troy Avenue

NATURE OF REQUEST: Application for a variation to reduce the north setback from 4' to 3', south setback from 4' to 3', combined side setback from 7.5' to 6' for a proposed two-story single family residence and rear open deck.

**ACTION OF BOARD-
VARIATION GRANTED**

THE VOTE

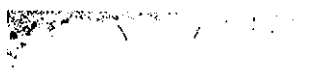
MAR 18 2019
 CITY OF CHICAGO
 ZONING BOARD OF APPEALS

SHAINA DOAR
SOL FLORES
SAM TOIA
AMANDA WILLIAMS

AFFIRMATIVE	NEGATIVE	ABSENT
X		
		X
X		
X		

THE RESOLUTION:

WHEREAS, a public hearing was held on this application by the Zoning Board of Appeals at its regular meeting held on February 15, 2019 after due notice thereof as provided under Section 17-13-0107B and by publication in the Chicago Times on January 4, 2019; and

WHEREAS, the Zoning Board of Appeals, having reviewed the proposed finding of fact and having fully heard the testimony and arguments of the parties and being fully advised in the premises, hereby finds the following; the applicant shall be permitted to reduce the north setback to 3', south setback to 3', combined side setback to 6' for a proposed two-story single family residence and rear open deck; the Board finds 1) strict compliance with the regulations and standards of this Zoning Ordinance would create practical difficulties or particular hardships for the subject property; 2) the requested variation is consistent with the stated purpose and intent of this Zoning Ordinance; 3) the property in question cannot yield a reasonable return if permitted to be used only in accordance with the standards of this Zoning Ordinance; 4) the practical difficulties or particular hardships are due to unique circumstances and are not generally applicable to other similarly situated property; and 5) the variation, if granted will not alter the essential character of the neighborhood; it is therefore

RESOLVED, that the Zoning Board of Appeals, by virtue of the authority conferred upon it, does hereby make a variation in the application of the district regulations of the zoning ordinance and that the aforesaid variation request be and it hereby is granted subject to the following condition(s):

That all applicable ordinances of the City of Chicago shall be complied with before a permit is issued.

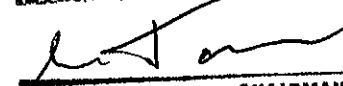
APPROVED AS TO SUBSTANCE

 CHAIRMAN

ZONING BOARD OF APPEALS, CITY OF CHICAGO, CITY HALL, ROOM 905

APPLICANT: Shepherd Real Estate Subsidiary, LLC-1901 Halsted Series

CAL NO.: 79-19-Z

APPEARANCE FOR: Thomas Moore

MINUTES OF MEETING:
February 15, 2019

APPEARANCE AGAINST: None

PREMISES AFFECTED: 1877 N. Halsted Street

NATURE OF REQUEST: Application for a variation to reduce the rear setback from the required 39.38' to 5' for a proposed four-story, twelve dwelling unit building with an attached thirteen car garage with rood decks and access stairs.

ACTION OF BOARD-
Continued to March 15, 2019 at 9:00 a.m.

THE VOTE

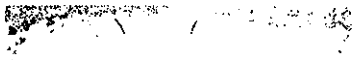

MAR 18 2019

CITY OF CHICAGO
ZONING BOARD OF APPEALS

SHAINA DOAR
SOL FLORES
SAM TOIA
AMANDA WILLIAMS

AFFIRMATIVE	NEGATIVE	ABSENT
X		
X		
X		
X		

APPROVED AS TO SUBSTANCE

CHAIRMAN

ZONING BOARD OF APPEALS, CITY OF CHICAGO, CITY HALL, ROOM 905

APPLICANT: Shepherd Real Estate Subsidiary, LLC-1901 Halsted Series

CAL NO.: 80-19-Z

APPEARANCE FOR: Thomas Moore

MINUTES OF MEETING:
February 15, 2019

APPEARANCE AGAINST: None

PREMISES AFFECTED: 1877 N. Halsted Street

NATURE OF REQUEST: Application for a variation to relocate the required 832.35 square feet of rear yard open space to a deck or patio which is more than 4' above grade for a proposed four-story, twelve dwelling unit building with an attached thirteen car garage with roof decks and access stairs.

ACTION OF BOARD-

Continued to March 15, 2019 at 9:00 a.m.

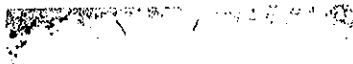

MAR 18 2019

CITY OF CHICAGO
ZONING BOARD OF APPEALS

SHAINA DOAR
SOL FLORES
SAM TOIA
AMANDA WILLIAMS

THE VOTE

AFFIRMATIVE	NEGATIVE	ABSENT
X		
X		
X		
X		

ZONING BOARD OF APPEALS, CITY OF CHICAGO, CITY HALL, ROOM 905

APPLICANT: Shepherd Real Estate Subsidiary, LLC-1901 Halsted Series

CAL NO.: 81-19-Z

APPEARANCE FOR: Thomas Moore

MINUTES OF MEETING:
February 15, 2019

APPEARANCE AGAINST: None

PREMISES AFFECTED: 1877 N. Halsted Street

NATURE OF REQUEST: Application for a variation to allow a 16' wide driveway along a pedestrian street to access required parking on a lot that does not have alley access for a proposed four-story, twelve dwelling unit building with an attached thirteen car garage with roof decks and stairs for access.

ACTION OF BOARD-
Continued to March 15, 2019 at 9:00 a.m.

THE VOTE

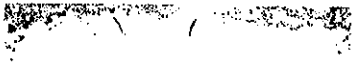

MAR 18 2019

CITY OF CHICAGO
ZONING BOARD OF APPEALS

SHAINA DOAR
SOL FLORES
SAM TOIA
AMANDA WILLIAMS

AFFIRMATIVE	NEGATIVE	ABSENT
X		
X		
X		
X		

APPROVED AS TO SUBSTANCE

CHAIRMAN

ZONING BOARD OF APPEALS, CITY OF CHICAGO, CITY HALL, ROOM 905

APPLICANT: Shepherd Real Estate Subsidiary, LLC-1901 Halsted Series

CAL NO.: 82-19-Z

APPEARANCE FOR: Thomas Moore

MINUTES OF MEETING:
February 15, 2019

APPEARANCE AGAINST: None

PREMISES AFFECTED: 1877 N. Halsted Street

NATURE OF REQUEST: Application for a variation to reduce the required 25% of street facing transparent window area from the required 291.6 square feet to 218.7 square feet, and to allow a recessed entry along a pedestrian street that is 22.31' in width and 15.13' in depth, for a proposed four-story, twelve dwelling unit building with an attached thirteen car garage with roof decks and stairs to access.

ACTION OF BOARD-

Continued to March 15, 2019 at 9:00 a.m.

THE VOTE

MAR 18 2019
CITY OF CHICAGO
ZONING BOARD OF APPEALS

SHAINA DOAR
SOL FLORES
SAM TOIA
AMANDA WILLIAMS

AFFIRMATIVE	NEGATIVE	ABSENT
X		
X		
X		
X		

APPROVED AS TO SUBSTANCE

CHAIRMAN

ZONING BOARD OF APPEALS, CITY OF CHICAGO, CITY HALL, ROOM 905

APPLICANT: 1204 N. Spaulding, LLC

CAL NO.: 83-19-S

APPEARANCE FOR: Paul Kolpak

MINUTES OF MEETING:
February 15, 2019

APPEARANCE AGAINST: None

PREMISES AFFECTED: 1204 N. Spaulding Avenue

NATURE OF REQUEST: Application for a special use to establish residential use below the second floor for a proposed three-story, six dwelling unit building.

**ACTION OF BOARD-
APPLICATION APPROVED**

THE VOTE

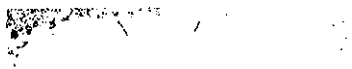

MAR 18 2019

CITY OF CHICAGO
ZONING BOARD OF APPEALS

SHAINA DOAR
SOL FLORES
SAM TOIA
AMANDA WILLIAMS

AFFIRMATIVE	NEGATIVE	ABSENT
X		
		X
X		
X		

THE RESOLUTION:

WHEREAS, a public hearing was held on this application by the Zoning Board of Appeals at its regular meeting held on February 15, 2019 after due notice thereof as provided under Section 17-13-0107B and by publication in the Chicago Times on January 4, 2019; and

WHEREAS, the Zoning Board of Appeals, having reviewed the proposed finding of fact and having fully heard the testimony and arguments of the parties and being fully advised in the premises, hereby finds the following; the applicant shall be permitted to establish residential use below the second floor for a proposed three-story, six dwelling unit building; expert testimony was offered that the use would not have a negative impact on the surrounding community and is in character with the neighborhood; further expert testimony was offered that the use complies with all of the criteria as set forth by the code for the granting of a special use at the subject site; the Board finds the use complies with all applicable standards of this Zoning Ordinance; is in the interest of the public convenience and will not have a significant adverse impact on the general welfare of neighborhood or community; is compatible with the character of the surrounding area in terms of site planning and building scale and project design; is compatible with the character of the surrounding area in terms of operating characteristics, such as hours of operation, outdoor lighting, noise, and traffic generation; and is designed to promote pedestrian safety and comfort; it is therefore

RESOLVED, that the aforesaid special use request be and it hereby is approved and the Zoning Administrator is authorized to permit said special use subject to the following condition(s): provided the special use is issued solely to the applicant, 1204 N. Spaulding, LLC the development is consistent with the design and layout of the plans and drawings dated December 6, 2018, prepared by Vari Architects, Ltd.

That all applicable ordinances of the City of Chicago shall be complied with before a permit is issued.

APPROVED AS TO SUBSTANCE

[Signature]
CHAIRMAN

ZONING BOARD OF APPEALS, CITY OF CHICAGO, CITY HALL, ROOM 905

APPLICANT: Thorntons Inc. c/o Drew Zazofsky **CAL NO.:** 84-19-S

APPEARANCE FOR: Tyler Manic **MINUTES OF MEETING:**
February 15, 2019

APPEARANCE AGAINST: None

PREMISES AFFECTED: 2335-61 W. Ogden/2300-36 W. 13th St./1230-52 S. Oakley

NATURE OF REQUEST: Application for a special use to establish a gas station with a one-story accessory retail building.

ACTION OF BOARD-
Continued to March 15, 2019 at 9:00 a.m.

THE VOTE

MAR 18 2019
CITY OF CHICAGO
ZONING BOARD OF APPEALS

SHAINA DOAR
SOL FLORES
SAM TOIA
AMANDA WILLIAMS

AFFIRMATIVE	NEGATIVE	ABSENT
X		
X		
X		
X		

APPROVED AS TO SUBSTANCE

CHAIRMAN

ZONING BOARD OF APPEALS, CITY OF CHICAGO, CITY HALL, ROOM 905

APPLICANT: Shedeh Abu-Khalil

CAL NO.: 85-19-S

APPEARANCE FOR: John Pikarski

MINUTES OF MEETING:
February 15, 2019

APPEARANCE AGAINST: None

PREMISES AFFECTED: 5831-51 S. Wentworth Avenue

NATURE OF REQUEST: Application for a special use to establish a gas station with a one-story convenience store.

**ACTION OF BOARD-
APPLICATION APPROVED**

THE VOTE

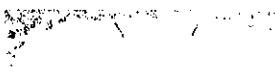

MAR 18 2019

CITY OF CHICAGO
ZONING BOARD OF APPEALS

SHAINA DOAR

SOL FLORES

SAM TOIA

AMANDA WILLIAMS

AFFIRMATIVE	NEGATIVE	ABSENT
X		
		X
X		
X		

THE RESOLUTION:

WHEREAS, a public hearing was held on this application by the Zoning Board of Appeals at its regular meeting held February 15, 2019 after due notice thereof as provided under Section 17-13-0107B and by publication in the Chicago Sun-Times on January 4, 2019; and

WHEREAS, the Zoning Board of Appeals, having reviewed the proposed finding of fact and having fully heard the testimony and arguments of the parties and being fully advised in the premises, hereby finds the following; the applicant shall be permitted to establish a gas station with a one-story convenience store; expert testimony was offered that the use would not have a negative impact on the surrounding community and is in character with the neighborhood; further expert testimony was offered that the use complies with all of the criteria as set forth by the code for the granting of a special use at the subject site; the Board finds the use complies with all applicable standards of this Zoning Ordinance; is in the interest of the public convenience and will not have a significant adverse impact on the general welfare of neighborhood or community; is compatible with the character of the surrounding area in terms of site planning and building scale and project design; is compatible with the character of the surrounding area in terms of operating characteristics, such as hours of operation, outdoor lighting, noise, and traffic generation; and is designed to promote pedestrian safety and comfort; it is therefore

RESOLVED, that the aforesaid special use request be and it hereby is approved and the Zoning Administrator is authorized to permit said special use subject to the following condition(s): provided the special use is issued solely to the applicant Shedeh Abu-Khalil, and the development is consistent with the design and layout of the plans and drawings dated February 6, 2019, prepared by Projekt Studio, LLC.

That all applicable ordinances of the City of Chicago shall be complied with before a permit is issued.

APPROVED AS TO SUBSTANCE

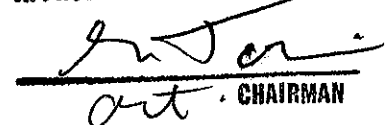
CHAIRMAN

ZONING BOARD OF APPEALS, CITY OF CHICAGO, CITY HALL, ROOM 905

APPLICANT: Ryan Barkan

CAL NO.: 86-19-Z

APPEARANCE FOR: John Pikarski

MINUTES OF MEETING:
February 15, 2019

APPEARANCE AGAINST: None

PREMISES AFFECTED: 6218 N. Lenox Avenue

NATURE OF REQUEST: Application for a variation to increase the maximum floor area from 0.65 to 0.74 for a proposed two-story addition at the rear of the existing single family residence.

**ACTION OF BOARD-
VARIATION GRANTED**

THE VOTE

MAR 18 2019
CITY OF CHICAGO
ZONING BOARD OF APPEALS

SHAINA DOAR
SOL FLORES
SAM TOIA
AMANDA WILLIAMS

AFFIRMATIVE	NEGATIVE	ABSENT
X		
		X
X		
X		

THE RESOLUTION:

WHEREAS, a public hearing was held on this application by the Zoning Board of Appeals at its regular meeting held February 15, 2019 after due notice thereof as provided under Section 17-13-0107B and by publication in the Chicago Sun-Times on January 4, 2019; and

WHEREAS, the Zoning Board of Appeals, having reviewed the proposed finding of fact and having fully heard the testimony and arguments of the parties and being fully advised in the premises, hereby finds the following; the applicant shall be permitted to increase the maximum floor area to 0.74 for a proposed two-story addition at the rear of the existing single family residence; the Board finds 1) strict compliance with the regulations and standards of this Zoning Ordinance would create practical difficulties or particular hardships for the subject property; 2) the requested variation is consistent with the stated purpose and intent of this Zoning Ordinance; 3) the property in question cannot yield a reasonable return if permitted to be used only in accordance with the standards of this Zoning Ordinance; 4) the practical difficulties or particular hardships are due to unique circumstances and are not generally applicable to other similarly situated property; and 5) the variation, if granted will not alter the essential character of the neighborhood; it is therefore

RESOLVED, that the Zoning Board of Appeals, by virtue of the authority conferred upon it, does hereby make a variation in the application of the district regulations of the zoning ordinance and that the aforesaid variation request be and it hereby is granted subject to the following condition(s):

That all applicable ordinances of the City of Chicago shall be complied with before a permit is issued.

APPROVED AS TO SUBSTANCE
[Signature]

CHAIRMAN

ZONING BOARD OF APPEALS, CITY OF CHICAGO, CITY HALL, ROOM 905

APPLICANT: C & N Land Holdings, LLC

CAL NO.: 87-19-Z

APPEARANCE FOR: Nicholas Ftikas

MINUTES OF MEETING:
February 15, 2019

APPEARANCE AGAINST: None

PREMISES AFFECTED: 2329-31 W. Monroe Street

NATURE OF REQUEST: Application for a variation to reduce the on-site parking by two spaces for an existing three-story, six dwelling unit building to be converted to an eight-dwelling unit building with five existing on-site parking spaces.

**ACTION OF BOARD-
VARIATION GRANTED**

THE VOTE

 MAR 18 2019
 CITY OF CHICAGO
 ZONING BOARD OF APPEALS

SHAINA DOAR
SOL FLORES
SAM TOIA
AMANDA WILLIAMS

AFFIRMATIVE	NEGATIVE	ABSENT
X		
		X
X		
X		

THE RESOLUTION:

WHEREAS, a public hearing was held on this application by the Zoning Board of Appeals at its regular meeting held February 15, 2019 after due notice thereof as provided under Section 17-13-0107B and by publication in the Chicago Sun-Times on January 4, 2019; and

WHEREAS, the Zoning Board of Appeals, having reviewed the proposed finding of fact and having fully heard the testimony and arguments of the parties and being fully advised in the premises, hereby finds the following; the applicant shall be permitted to reduce the on-site parking by two spaces for an existing three-story, six dwelling unit building to be converted to an eight-dwelling unit building with five existing on-site parking spaces; the Board finds 1) strict compliance with the regulations and standards of this Zoning Ordinance would create practical difficulties or particular hardships for the subject property; 2) the requested variation is consistent with the stated purpose and intent of this Zoning Ordinance; 3) the property in question cannot yield a reasonable return if permitted to be used only in accordance with the standards of this Zoning Ordinance; 4) the practical difficulties or particular hardships are due to unique circumstances and are not generally applicable to other similarly situated property; and 5) the variation, if granted will not alter the essential character of the neighborhood; it is therefore

RESOLVED, that the Zoning Board of Appeals, by virtue of the authority conferred upon it, does hereby make a variation in the application of the district regulations of the zoning ordinance and that the aforesaid variation request be and it hereby is granted subject to the following condition(s):

That all applicable ordinances of the City of Chicago shall be complied with before a permit is issued.

APPROVED AS TO SUBSTANCE



 CHAIRMAN

ZONING BOARD OF APPEALS, CITY OF CHICAGO, CITY HALL, ROOM 905

APPLICANT: Drew Martin

CAL NO.: 88-19-S

APPEARANCE FOR: John Pikarski

MINUTES OF MEETING:
February 15, 2019

APPEARANCE AGAINST: None

PREMISES AFFECTED: 2724 E. 83rd Street

NATURE OF REQUEST: Application for a special use to establish a barber shop.

**ACTION OF BOARD-
APPLICATION APPROVED**

THE VOTE

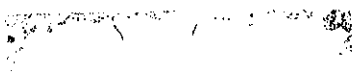

MAR 18 2019

CITY OF CHICAGO
ZONING BOARD OF APPEALS

SHAINA DOAR
SOL FLORES
SAM TOIA
AMANDA WILLIAMS

AFFIRMATIVE	NEGATIVE	ABSENT
X		
		X
X		
X		

THE RESOLUTION:

WHEREAS, a public hearing was held on this application by the Zoning Board of Appeals at its regular meeting held on February 15, 2019 after due notice thereof as provided under Section 17-13-0107B and by publication in the Chicago Sun-Times on January 4, 2019; and

WHEREAS, the Zoning Board of Appeals, having reviewed the proposed finding of fact and having fully heard the testimony and arguments of the parties and being fully advised in the premises, hereby finds the following; the applicant shall be permitted to establish a barber shop; further expert testimony was offered that the use complies with all of the criteria as set forth by the code for the granting of a special use at the subject site; the Board finds the use complies with all applicable standards of this Zoning Ordinance; is in the interest of the public convenience and will not have a significant adverse impact on the general welfare of neighborhood or community; is compatible with the character of the surrounding area in terms of site planning and building scale and project design; is compatible with the character of the surrounding area in terms of operating characteristics, such as hours of operation, outdoor lighting, noise, and traffic generation; and is designed to promote pedestrian safety and comfort; it is therefore

RESOLVED, that the aforesaid special use request be and it hereby is approved and the Zoning Administrator is authorized to permit said special use subject to the following condition(s): provided the special use is issued solely to the applicant, Drew Martin.

That all applicable ordinances of the City of Chicago shall be complied with before a permit is issued.

APPROVED AS TO SUBSTANCE

[Signature]

CHAIRMAN

ZONING BOARD OF APPEALS, CITY OF CHICAGO, CITY HALL, ROOM 905

APPLICANT: John Difilippo
APPEARANCE FOR: Same as Applicant
APPEARANCE AGAINST: None
PREMISES AFFECTED: 2645 W. 107th Street

CAL NO.: 89-19-Z

MINUTES OF MEETING:
February 15, 2019

NATURE OF REQUEST: Application for a variation to increase the area occupied by an accessory building in the rear setback from the maximum 1,008 square feet to 1,102.90 square feet (16.34' x 20.10') which serves the existing single family residence.

ACTION OF BOARD-
Continued to March 15, 2019 at 9:00 a.m.

THE VOTE

MAR 18 2019
CITY OF CHICAGO
ZONING BOARD OF APPEALS

SHAINA DOAR
SOL FLORES
SAM TOIA
AMANDA WILLIAMS

AFFIRMATIVE	NEGATIVE	ABSENT
X		
		X
X		
X		

ZONING BOARD OF APPEALS, CITY OF CHICAGO, CITY HALL, ROOM 905

APPLICANT: 7934 South Chicago, LLC

CAL NO.: 90-19-S

APPEARANCE FOR: Thomas Moore

MINUTES OF MEETING:
February 15, 2019

APPEARANCE AGAINST: None

PREMISES AFFECTED: 7934 S. South Chicago Avenue

NATURE OF REQUEST: Application for a special use to establish a Class V Recycling Facility.

ACTION OF BOARD-
APPLICATION APPROVED

THE VOTE

MAR 18 2019
CITY OF CHICAGO
ZONING BOARD OF APPEALS

SHAINA DOAR
SOL FLORES
SAM TOIA
AMANDA WILLIAMS

AFFIRMATIVE	NEGATIVE	ABSENT
X		
X		
X		
X		

THE RESOLUTION:

WHEREAS, a public hearing was held on this application by the Zoning Board of Appeals at its regular meeting held on February 15, 2019 after due notice thereof as provided under Section 17-13-0107B and by publication in the Chicago Sun-Times on January 4, 2019; and

WHEREAS, the Zoning Board of Appeals, having reviewed the proposed finding of fact and having fully heard the testimony and arguments of the parties and being fully advised in the premises, hereby finds the following; the applicant shall be permitted to establish a Class V Recycling Facility; further expert testimony was offered that the use complies with all of the criteria as set forth by the code for the granting of a special use at the subject site; the Board finds the use complies with all applicable standards of this Zoning Ordinance; is in the interest of the public convenience and will not have a significant adverse impact on the general welfare of neighborhood or community; is compatible with the character of the surrounding area in terms of site planning and building scale and project design; is compatible with the character of the surrounding area in terms of operating characteristics, such as hours of operation, outdoor lighting, noise, and traffic generation; and is designed to promote pedestrian safety and comfort; it is therefore

RESOLVED, that the aforesaid special use request be and it hereby is approved and the Zoning Administrator is authorized to permit said special use subject to the following condition(s): provided the special use is issued solely to the applicant 7934 South Chicago, LLC, and the development is consistent with the design and layout of the plans and drawings dated February 15, 2019, prepared by Sullivan, Goulette & Wilson Architects.

That all applicable ordinances of the City of Chicago shall be complied with before a permit is issued.

APPROVED AS TO SUBSTANCE
[Signature]
CHAIRMAN

ZONING BOARD OF APPEALS, CITY OF CHICAGO, CITY HALL, ROOM 905

APPLICANT: 2232 Lawrence, LLC

CAL NO.: 91-19-S

APPEARANCE FOR: Thomas Moore

MINUTES OF MEETING:
February 15, 2019

APPEARANCE AGAINST: None

PREMISES AFFECTED: 4802 N. Bell Avenue

NATURE OF REQUEST: Application for a special use to establish a hair salon.

**ACTION OF BOARD-
APPLICATION APPROVED**

THE VOTE

MAR 18 2019
CITY OF CHICAGO
ZONING BOARD OF APPEALS

SHAINA DOAR
SOL FLORES
SAM TOIA
AMANDA WILLIAMS

AFFIRMATIVE	NEGATIVE	ABSENT
X		
X		
X		
X		

THE RESOLUTION:

WHEREAS, a public hearing was held on this application by the Zoning Board of Appeals at its regular meeting held on February 15, 2019 after due notice thereof as provided under Section 17-13-0107B and by publication in the Chicago Sun-Times on January 4, 2019; and

WHEREAS, the Zoning Board of Appeals, having reviewed the proposed finding of fact and having fully heard the testimony and arguments of the parties and being fully advised in the premises, hereby finds the following; the applicant shall be permitted to establish a hair salon; further expert testimony was offered that the use complies with all of the criteria as set forth by the code for the granting of a special use at the subject site; the Board finds the use complies with all applicable standards of this Zoning Ordinance; is in the interest of the public convenience and will not have a significant adverse impact on the general welfare of neighborhood or community; is compatible with the character of the surrounding area in terms of site planning and building scale and project design; is compatible with the character of the surrounding area in terms of operating characteristics, such as hours of operation, outdoor lighting, noise, and traffic generation; and is designed to promote pedestrian safety and comfort; it is therefore

RESOLVED, that the aforesaid special use request be and it hereby is approved and the Zoning Administrator is authorized to permit said special use subject to the following condition(s): provided the special use is issued solely to the applicant, 2232 Lawrence, LLC.

That all applicable ordinances of the City of Chicago shall be complied with before a permit is issued.

APPROVED AS TO SUBSTANCE
[Signature]
CHAIRMAN

ZONING BOARD OF APPEALS, CITY OF CHICAGO, CITY HALL, ROOM 905

APPLICANT: 2242 Lawrence, LLC

CAL NO.: 92-19-S

APPEARANCE FOR: Thomas Moore

MINUTES OF MEETING:
February 15, 2019

APPEARANCE AGAINST: None

PREMISES AFFECTED: 2242-46 W. Lawrence Avenue

NATURE OF REQUEST: Application for a special use to establish a hair salon.

**ACTION OF BOARD-
APPLICATION APPROVED**

THE VOTE

MAR 18 2019
CITY OF CHICAGO
ZONING BOARD OF APPEALS

SHAINA DOAR
SOL FLORES
SAM TOIA
AMANDA WILLIAMS

AFFIRMATIVE	NEGATIVE	ABSENT
X		
X		
X		
X		

THE RESOLUTION:

WHEREAS, a public hearing was held on this application by the Zoning Board of Appeals at its regular meeting held on February 15, 2019 after due notice thereof as provided under Section 17-13-0107B and by publication in the Chicago Sun-Times on January 4, 2019; and

WHEREAS, the Zoning Board of Appeals, having reviewed the proposed finding of fact and having fully heard the testimony and arguments of the parties and being fully advised in the premises, hereby finds the following; the applicant shall be permitted to establish a hair salon; further expert testimony was offered that the use complies with all of the criteria as set forth by the code for the granting of a special use at the subject site; the Board finds the use complies with all applicable standards of this Zoning Ordinance; is in the interest of the public convenience and will not have a significant adverse impact on the general welfare of neighborhood or community; is compatible with the character of the surrounding area in terms of site planning and building scale and project design; is compatible with the character of the surrounding area in terms of operating characteristics, such as hours of operation, outdoor lighting, noise, and traffic generation; and is designed to promote pedestrian safety and comfort; it is therefore

RESOLVED, that the aforesaid special use request be and it hereby is approved and the Zoning Administrator is authorized to permit said special use subject to the following condition(s): provided the special use is issued solely to the applicant, 2242 W. Lawrence, LLC.

That all applicable ordinances of the City of Chicago shall be complied with before a permit is issued.

APPROVED AS TO SUBSTANCE

[Signature]

CHAIRMAN

**ZONING BOARD OF APPEALS
CITY OF CHICAGO**

City Hall Room 905
121 North LaSalle Street
Chicago, Illinois 60602
TEL: (312) 744-3888



MAR 18 2019

CITY OF CHICAGO
ZONING BOARD OF APPEALS

J. Luis Cazares

APPLICANT

93-19-Z

CALENDAR NUMBER

3610 S. Albany Avenue

PREMISES AFFECTED

February 15, 2019

HEARING DATE

ACTION OF BOARD

THE VOTE

The application for the variation is approved subject to the condition set forth in this decision.

Shaina Doar
Sol Flores
Sam Toia
Amanda Williams

AFFIRMATIVE	NEGATIVE	ABSENT
<input checked="" type="checkbox"/>	<input type="checkbox"/>	<input type="checkbox"/>
<input checked="" type="checkbox"/>	<input type="checkbox"/>	<input type="checkbox"/>
<input checked="" type="checkbox"/>	<input type="checkbox"/>	<input type="checkbox"/>
<input checked="" type="checkbox"/>	<input type="checkbox"/>	<input type="checkbox"/>

**FINDINGS OF THE ZONING BOARD OF APPEALS
IN THE MATTER OF THE VARIATION APPLICATION FOR 3610 S. ALBANY
AVENUE BY J. LUIS CAZARES.**

I. BACKGROUND

J. Luis Cazares (the "Applicant") submitted a variation application for 3610 S. Albany Avenue (the "subject property"). The subject property is currently zoned M2-2 and is currently improved with a two-story building (the "existing building") and a surface parking lot (the "lot"). The Applicant uses the existing building for his business. As part of the operations of the business, the lot is used for trucks and equipment. The Applicant had previously erected an 18.5' tall rolling fence (the "fence") along a portion of the east property line of the subject property. The fence was built without permits. The Applicant sought a variation to reduce the front setback from the required 20' to 0' to legalize the fence.

II. PUBLIC HEARING

A. The Hearing

The ZONING BOARD OF APPEALS held a public hearing on the Applicant's variation application at its regular meeting held on February 15, 2019, after due notice thereof as provided under Section 17-13-0107-B of the Chicago Zoning Ordinance and by publication in the *Chicago Sun-Times*. In accordance with the ZONING BOARD OF APPEALS' Rules of Procedure, the Applicant had submitted his proposed Findings of Fact. The Applicant J. Luis Cazares was present. The statements and testimony given

APPROVED AS TO SUBSTANCE



CHAIRMAN

during the public hearing were given in accordance with the ZONING BOARD OF APPEALS' Rules of Procedure.

The Applicant Mr. J. Luis Cazares testified that he utilizes the lot to park his business's trucks and equipment. The Applicant testified that he previously had an old and dilapidated cyclone fence to secure the lot but people would break in. The Applicant testified that because of his concern for safety, he replaced the cyclone fence with the rolling iron fence that exceeded 6' in height.

The ZONING BOARD OF APPEALS restated that the Applicant's hardship concerned the trucks parked in the lot and security. The ZONING BOARD OF APPEALS asked the Applicant, should the ZONING BOARD OF APPEALS grant the Applicant's application, if the Applicant would be willing to install a screen to the fence to conceal the lot from the residences across the street.

Mr. Cazares testified that he would be willing to do so.

B. Criteria for a Variation

Pursuant to Section 17-13-1107-A of the Chicago Zoning Ordinance, no variation application may be approved unless the ZONING BOARD OF APPEALS finds, based upon the evidence presented to it in each specific case, that: (1) strict compliance with the standards of the Chicago Zoning Ordinance would create practical difficulties or particular hardships; and (2) the requested variation is consistent with the stated purpose and intent of the Chicago Zoning Ordinance.

Pursuant to Section 17-13-1107-B of the Chicago Zoning Ordinance, in order to determine that practical difficulties or particular hardships exist, the ZONING BOARD OF APPEALS must find evidence of each of the following: (1) the property in question cannot yield a reasonable return if permitted to be used only in accordance with the standards of the Chicago Zoning Ordinance; (2) the practical difficulties or particular hardships are due to unique circumstances and are not generally applicable to other similarly situated property; and (3) the variation, if granted, will not alter the essential character of the neighborhood.

Pursuant to Section 17-13-1107-C of the Chicago Zoning Ordinance, in making its determination of whether practical difficulties or particular hardships exist, the ZONING BOARD OF APPEALS must take into consideration the extent to which evidence has been submitted substantiating the following facts: (1) the particular physical surroundings, shape or topographical condition of the specific property involved would result in a particular hardship upon the property owner as distinguished from a mere inconvenience, if the strict letter of the regulations were carried out; (2) the conditions upon which the petition for a variation is based would not be applicable, generally, to other property within the same zoning classification; (3) the purpose of the variation is not based exclusively upon a desire to make more money out of the property; (4) the alleged practical difficulty or particular hardship has not been created by any person

presently having an interest in the property; (5) the granting of the variation will not be detrimental to the public welfare or injurious to other property or improvements in the neighborhood in which the property is located; and (6) the proposed variation will not impair an adequate supply of light and air to adjacent property, or substantially increase the congestion in the public streets, or increase the danger of fire, or endanger the public safety, or substantially diminish or impair property values within the neighborhood.

III. FINDINGS OF FACT.

After careful consideration of the evidence, testimony and the entire record, including the Applicant's proposed Findings of Fact, the ZONING BOARD OF APPEALS hereby makes the following findings with reference to the Applicant's application for a variation pursuant to Section 17-13-1107-A of the Chicago Zoning Ordinance:

1. *Strict compliance with the regulations and standards of the Chicago Zoning Ordinance would create practical difficulties or particular hardships for the subject property.*

As the Applicant credibly testified and as set forth in the Applicant's proposed Findings of Fact, the fence has already been constructed on the subject property to provide security for the trucks and equipment on the lot. To demolish and replace the fence in accordance with the standards of the Chicago Zoning Ordinance would result in practical difficulties or particular hardships.

2. *The requested variation is consistent with the stated purpose and intent of the Chicago Zoning Ordinance.*

The requested variation and proposed development is consistent with the stated purpose and intent of the Chicago Zoning Ordinance, specifically by: (1) promoting the public health, safety and general welfare pursuant to Section 17-1-0501 of the Chicago Zoning Ordinance; and (2) ensuring adequate light, air, privacy, and access to property pursuant to Section 17-1-0509 of the Chicago Zoning Ordinance.

After careful consideration of the evidence, testimony and the entire record, including the Applicant's proposed Findings of Fact, the ZONING BOARD OF APPEALS hereby makes the following findings with reference to the Applicant's application for a variation pursuant to Section 17-13-1107-B of the Chicago Zoning Ordinance:

1. *The property in question cannot yield a reasonable return if permitted to be used only in accordance with the standards of the Chicago Zoning Ordinance.*

As the Applicant credibly testified and as set forth in the Applicant's proposed Findings of Fact, to demolish and rebuild the fence in accordance with the standards of the Chicago Zoning Ordinance, the result would be expensive and impractical and will not provide sufficient parking and safety for the trucks and equipment in the lot.

2. *The practical difficulties or particular hardships are due to unique circumstances and are not generally applicable to other similarly situated property.*

Demolishing and rebuilding the fence would be a unique circumstance and would not be generally applicable to other manufacturing property.

3. *The variation, if granted, will not alter the essential character of the neighborhood.*

As set forth in the Applicant's proposed Findings of Fact, the fence will promote safety and its wrought iron style will be more appealing than the former dilapidated cyclone wire fence. Furthermore, due to the condition imposed by the ZONING BOARD OF APPEALS, the lot will be shielded from the residences across the street by a screen to be installed on the fence.

After careful consideration of the evidence, testimony and the entire record, including the Applicant's proposed Findings of Fact, the ZONING BOARD OF APPEALS hereby makes the following findings with reference to the Applicant's application for a variation pursuant to Section 17-13-1107-C of the Chicago Zoning Ordinance:

1. *The particular physical surroundings, shape or topographical condition of the specific property involved would result in a particular hardship upon the property owner as distinguished from a mere inconvenience, if the strict letter of the regulations were carried out.*

As noted above, to demolish and rebuild the fence in accordance with the standards of the Chicago Zoning Ordinance, the result would be expensive and impractical and will not provide sufficient parking and safety for the trucks and equipment in the lot.

2. *The conditions upon which the petition for the variation are based would not be applicable, generally, to other property within the same zoning classification.*

Demolishing and rebuilding the fence is a condition not applicable, generally, to other property within the M2-2 zoning district.

3. *The purpose of the variation is not based exclusively upon a desire to make more money out of the property.*

As set forth in the Applicant's proposed Findings of Fact, the Applicant's business will remain at the subject property. Further, the purpose of the fence is to protect his trucks and equipment. The variation is not based exclusively upon a desire to make more money out of the property but rather a desire to legalize the Applicant's existing fence.

4. *The alleged practical difficulty or particular hardship has not been created by any person presently having an interest in the property.*

As set forth in the Applicant's proposed Findings of Fact, the Applicant hired a fence company to construct the fence and was not made aware of the permit requirement. The variation is based on the Applicant's desire to legalize the existing fence.

5. *The granting of the variation will not be detrimental to the public welfare or injurious to other property or improvements in the neighborhood in which the property is located.*

Due to the condition imposed by the ZONING BOARD OF APPEALS, the granting of the variation will not be detrimental to the public welfare or injurious to other property or improvements in the area.

6. *The variation will not impair an adequate supply of light and air to adjacent property, or substantially increase the congestion in the public streets, or increase the danger of fire, or endanger the public safety, or substantially diminish or impair property values within the neighborhood.*

As noted above, the variation will not impair an adequate supply of light and air to adjacent properties. The variation will not increase the danger of fire. Further, due to the condition imposed by the ZONING BOARD OF APPEALS, the variation will not endanger the public safety, or substantially diminish or impair property values within the neighborhood.

IV. CONCLUSION

For all of these reasons, the ZONING BOARD OF APPEALS finds that the Applicant has proved its case by evidence, testimony and the entire record, including the Applicant's proposed Findings of Fact, covering the specific criteria for a variation pursuant to Sections 17-13-1107-A, B and C of the Chicago Zoning Ordinance.

The ZONING BOARD OF APPEALS hereby approves the Applicant's application for a variation, and pursuant to the authority granted to the ZONING BOARD OF APPEALS by Section 17-13-1105 of the Chicago Zoning Ordinance, the Zoning Administrator is authorized to permit said variation subject to the following condition:

1. The Applicant shall install a screen to the fence to shield the lot from the residential homes across the street on Albany Avenue.

This is a final decision subject to review under the Illinois Administrative Review Law, 735 ILCS 5/3-101 *et seq.*

ZONING BOARD OF APPEALS, CITY OF CHICAGO, CITY HALL, ROOM 905

APPLICANT: YLS, Inc. an Illinois Corporation **CAL NO.:** 94-19-Z
APPEARANCE FOR: C. Harrison Cooper **MINUTES OF MEETING:**
 February 15, 2019
APPEARANCE AGAINST: None
PREMISES AFFECTED: 1851 N. Wilmot Avenue

NATURE OF REQUEST: Application for a variation to reduce the front setback from the required 37.02' to 10' for a proposed two-story single family residence.

**ACTION OF BOARD-
 VARIATION GRANTED**

THE VOTE

MAR 18 2019
 CITY OF CHICAGO
 ZONING BOARD OF APPEALS

SHAINA DOAR
 SOL FLORES
 SAM TOIA
 AMANDA WILLIAMS

AFFIRMATIVE	NEGATIVE	ABSENT
X		
X		
X		
X		

THE RESOLUTION:

WHEREAS, a public hearing was held on this application by the Zoning Board of Appeals at its regular meeting held on February 15, 2019 after due notice thereof as provided under Section 17-13-0107B and by publication in the Chicago Tribune on January 4, 2019; and

WHEREAS, the Zoning Board of Appeals, having reviewed the proposed finding of fact and having fully heard the testimony and arguments of the parties and being fully advised in the premises, hereby finds the following; the applicant shall be permitted to reduce the front setback to 10' for a proposed two-story single family residence; the Board finds 1) strict compliance with the regulations and standards of this Zoning Ordinance would create practical difficulties or particular hardships for the subject property; 2) the requested variation is consistent with the stated purpose and intent of this Zoning Ordinance; 3) the property in question cannot yield a reasonable return if permitted to be used only in accordance with the standards of this Zoning Ordinance; 4) the practical difficulties or particular hardships are due to unique circumstances and are not generally applicable to other similarly situated property; and 5) the variation, if granted will not alter the essential character of the neighborhood; it is therefore

RESOLVED, that the Zoning Board of Appeals, by virtue of the authority conferred upon it, does hereby make a variation in the application of the district regulations of the zoning ordinance and that the aforesaid variation request be and it hereby is granted subject to the following condition(s):

That all applicable ordinances of the City of Chicago shall be complied with before a permit is issued.

APPROVED AS TO SUBSTANCE

[Signature]

 CHAIRMAN

ZONING BOARD OF APPEALS, CITY OF CHICAGO, CITY HALL, ROOM 905

APPLICANT: Michael Facchini
APPEARANCE FOR: C. Harrison Cooper
APPEARANCE AGAINST: None
PREMISES AFFECTED: 1231 W. Lill Avenue

CAL NO.: 95-19-Z

MINUTES OF MEETING:
February 15, 2019

NATURE OF REQUEST: Application for a variation to reduce the rear setback from the required 19.13' to 5', east setback from 2' to zero (west to be 5.54'), combined side setback from 10.5' to 5.54' for a proposed second floor addition, attached two car garage with roof and new side deck to the existing single family residence.

**ACTION OF BOARD-
VARIATION GRANTED**

THE VOTE

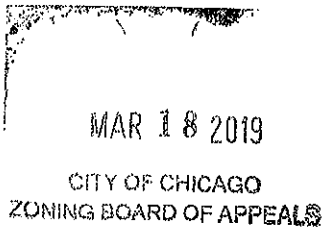

SHAINA DOAR
SOL FLORES
SAM TOIA
AMANDA WILLIAMS

AFFIRMATIVE	NEGATIVE	ABSENT
X		
X		
X		
X		

THE RESOLUTION:

WHEREAS, a public hearing was held on this application by the Zoning Board of Appeals at its regular meeting held February 15, 2019 after due notice thereof as provided under Section 17-13-0107B and by publication in the Chicago Sun-Times on January 4, 2019; and

WHEREAS, the Zoning Board of Appeals, having reviewed the proposed finding of fact and having fully heard the testimony and arguments of the parties and being fully advised in the premises, hereby finds the following; the applicant shall be permitted to reduce the rear setback to 5', east setback to zero (west to be 5.54'), combined side setback to 5.54' for a proposed second floor addition, attached two car garage with roof and new side deck to the existing single family residence; an additional variation was granted to the subject property in Cal. 96-19-Z; the Board finds 1) strict compliance with the regulations and standards of this Zoning Ordinance would create practical difficulties or particular hardships for the subject property; 2) the requested variation is consistent with the stated purpose and intent of this Zoning Ordinance; 3) the property in question cannot yield a reasonable return if permitted to be used only in accordance with the standards of this Zoning Ordinance; 4) the practical difficulties or particular hardships are due to unique circumstances and are not generally applicable to other similarly situated property; and 5) the variation, if granted will not alter the essential character of the neighborhood; it is therefore

RESOLVED, that the Zoning Board of Appeals, by virtue of the authority conferred upon it, does hereby make a variation in the application of the district regulations of the zoning ordinance and that the aforesaid variation request be and it hereby is granted subject to the following condition(s):

That all applicable ordinances of the City of Chicago shall be complied with before a permit is issued.

APPROVED AS TO SUBSTANCE

[Signature]

CHAIRMAN

ZONING BOARD OF APPEALS, CITY OF CHICAGO, CITY HALL, ROOM 905

APPLICANT: Michael Facchini

CAL NO.: 96-19-Z

APPEARANCE FOR: C. Harrison Cooper

MINUTES OF MEETING:
February 15, 2019

APPEARANCE AGAINST: None

PREMISES AFFECTED: 1231 W. Lill Avenue

NATURE OF REQUEST: Application for a variation to relocate the required 233.21 square feet of rear yard open space onto the roof deck of the proposed garage which will serve the existing single family residence.

**ACTION OF BOARD-
VARIATION GRANTED**

THE VOTE

MAR 18 2019
CITY OF CHICAGO
ZONING BOARD OF APPEALS

SHAINA DOAR
SOL FLORES
SAM TOIA
AMANDA WILLIAMS

AFFIRMATIVE	NEGATIVE	ABSENT
X		
X		
X		
X		

THE RESOLUTION:

WHEREAS, a public hearing was held on this application by the Zoning Board of Appeals at its regular meeting held February 15, 2019 after due notice thereof as provided under Section 17-13-0107B and by publication in the Chicago Sun-Times on January 4, 2019; and

WHEREAS, the Zoning Board of Appeals, having reviewed the proposed finding of fact and having fully heard the testimony and arguments of the parties and being fully advised in the premises, hereby finds the following; the applicant shall be permitted to relocate the required 233.21 square feet of rear yard open space onto the roof deck of the proposed garage which will serve the existing single family residence; an additional variation was granted to the subject property in Cal. 95-19-Z; the Board finds 1) strict compliance with the regulations and standards of this Zoning Ordinance would create practical difficulties or particular hardships for the subject property; 2) the requested variation is consistent with the stated purpose and intent of this Zoning Ordinance; 3) the property in question cannot yield a reasonable return if permitted to be used only in accordance with the standards of this Zoning Ordinance; 4) the practical difficulties or particular hardships are due to unique circumstances and are not generally applicable to other similarly situated property; and 5) the variation, if granted will not alter the essential character of the neighborhood; it is therefore

RESOLVED, that the Zoning Board of Appeals, by virtue of the authority conferred upon it, does hereby make a variation in the application of the district regulations of the zoning ordinance and that the aforesaid variation request be and it hereby is granted subject to the following condition(s):

That all applicable ordinances of the City of Chicago shall be complied with before a permit is issued.

APPROVED AS TO SUBSTANCE

[Signature]
CHAIRMAN

ZONING BOARD OF APPEALS, CITY OF CHICAGO, CITY HALL, ROOM 905

APPLICANT: Andres and Zaira Salazar

CAL NO.: 97-19-Z

APPEARANCE FOR: Mark Kupiec

MINUTES OF MEETING:
February 15, 2019

APPEARANCE AGAINST: None

PREMISES AFFECTED: 2359 N. Moody Avenue

NATURE OF REQUEST: Application for a variation to reduce the front setback from the required 19.08' to 7.75', north setback from 2.4' to 2.02' (south to be 3.08'), combined side setback from 6' to 5.1' for a proposed below grade entry stair to the basement dwelling unit and to replace the existing rear three- story enclosed porch with a three- story open porch for the existing three-story, three dwelling unit building.

**ACTION OF BOARD-
VARIATION GRANTED**

THE VOTE

MAR 18 2019
CITY OF CHICAGO
ZONING BOARD OF APPEALS

SHAINA DOAR
SOL FLORES
SAM TOIA
AMANDA WILLIAMS

AFFIRMATIVE	NEGATIVE	ABSENT
X		
X		
X		
X		

THE RESOLUTION:

WHEREAS, a public hearing was held on this application by the Zoning Board of Appeals at its regular meeting held on February 15, 2019 after due notice thereof as provided under Section 17-13-0107B and by publication in the Chicago Sun-Times on January 4, 2019; and

WHEREAS, the Zoning Board of Appeals, having reviewed the proposed finding of fact and having fully heard the testimony and arguments of the parties and being fully advised in the premises, hereby finds the following; the applicant shall be permitted to reduce the front setback to 7.75', north setback to 2.02' (south to be 3.08'), combined side setback to 5.1' for a proposed below grade entry stair to the basement dwelling unit and to replace the existing rear three- story enclosed porch with a three- story open porch for the existing three-story, three dwelling unit building; the Board finds 1) strict compliance with the regulations and standards of this Zoning Ordinance would create practical difficulties or particular hardships for the subject property; 2) the requested variation is consistent with the stated purpose and intent of this Zoning Ordinance; 3) the property in question cannot yield a reasonable return if permitted to be used only in accordance with the standards of this Zoning Ordinance; 4) the practical difficulties or particular hardships are due to unique circumstances and are not generally applicable to other similarly situated property; and 5) the variation, if granted will not alter the essential character of the neighborhood; it is therefore

RESOLVED, that the Zoning Board of Appeals, by virtue of the authority conferred upon it, does hereby make a variation in the application of the district regulations of the zoning ordinance and that the aforesaid variation request be and it hereby is granted subject to the following condition(s):

That all applicable ordinances of the City of Chicago shall be complied with before a permit is issued.

APPROVED AS TO SUBSTANCE

[Signature]
CHAIRMAN

ZONING BOARD OF APPEALS, CITY OF CHICAGO, CITY HALL, ROOM 905

APPLICANT: June Dang Nguyen dba Happy Nails Boutique, Inc.

CAL NO.: 98-19-S

APPEARANCE FOR: Same as Applicant

MINUTES OF MEETING:
February 15, 2019

APPEARANCE AGAINST: None

PREMISES AFFECTED: 2908 N. Ashland Avenue

NATURE OF REQUEST: Application for a special use to establish a nail salon.

**ACTION OF BOARD-
APPLICATION APPROVED**

THE VOTE

MAR 18 2019
CITY OF CHICAGO
ZONING BOARD OF APPEALS

SHAINA DOAR
SOL FLORES
SAM TOIA
AMANDA WILLIAMS

AFFIRMATIVE	NEGATIVE	ABSENT
		X
X		
X		
X		

THE RESOLUTION:

WHEREAS, a public hearing was held on this application by the Zoning Board of Appeals at its regular meeting held on February 15, 2019 after due notice thereof as provided under Section 17-13-0107B and by publication in the Chicago Sun-Times on January 4, 2019; and

WHEREAS, the Zoning Board of Appeals, having reviewed the proposed finding of fact and having fully heard the testimony and arguments of the parties and being fully advised in the premises, hereby finds the following; the applicant shall be permitted to establish a nail salon; further expert testimony was offered that the use complies with all of the criteria as set forth by the code for the granting of a special use at the subject site; the Board finds the use complies with all applicable standards of this Zoning Ordinance; is in the interest of the public convenience and will not have a significant adverse impact on the general welfare of neighborhood or community; is compatible with the character of the surrounding area in terms of site planning and building scale and project design; is compatible with the character of the surrounding area in terms of operating characteristics, such as hours of operation, outdoor lighting, noise, and traffic generation; and is designed to promote pedestrian safety and comfort; it is therefore

RESOLVED, that the aforesaid special use request be and it hereby is approved and the Zoning Administrator is authorized to permit said special use subject to the following condition(s): provided the special use is issued solely to the applicant, June Dang Nguyen.

That all applicable ordinances of the City of Chicago shall be complied with before a permit is issued.

APPROVED AS TO SUBSTANCE

[Signature]

CHAIRMAN

ZONING BOARD OF APPEALS, CITY OF CHICAGO, CITY HALL, ROOM 905

APPLICANT: Steven B. Friedle

CAL NO.: 99-19-Z

APPEARANCE FOR: David Fintz

MINUTES OF MEETING:
February 15, 2019

APPEARANCE AGAINST: None

PREMISES AFFECTED: 5138 W. Montana Street

NATURE OF REQUEST: Application for a variation to reduce the rear setback from the required 37.22' to zero for a proposed 8'-6" wrought iron sliding gate that serves the existing two-story, two dwelling unit building.

**ACTION OF BOARD-
VARIATION GRANTED**

THE VOTE

MAR 18 2019
CITY OF CHICAGO
ZONING BOARD OF APPEALS

SHAINA DOAR
SOL FLORES
SAM TOIA
AMANDA WILLIAMS

AFFIRMATIVE	NEGATIVE	ABSENT
		X
X		
X		
X		

THE RESOLUTION:

WHEREAS, a public hearing was held on this application by the Zoning Board of Appeals at its regular meeting held on February 15, 2019 after due notice thereof as provided under Section 17-13-0107B and by publication in the Chicago Tribune on January 4, 2019; and

WHEREAS, the Zoning Board of Appeals, having reviewed the proposed finding of fact and having fully heard the testimony and arguments of the parties and being fully advised in the premises, hereby finds the following; the applicant shall be permitted to reduce the rear setback to zero for a proposed 8'-6" wrought iron sliding gate that serves the existing two-story, two dwelling unit building; the Board finds 1) strict compliance with the regulations and standards of this Zoning Ordinance would create practical difficulties or particular hardships for the subject property; 2) the requested variation is consistent with the stated purpose and intent of this Zoning Ordinance; 3) the property in question cannot yield a reasonable return if permitted to be used only in accordance with the standards of this Zoning Ordinance; 4) the practical difficulties or particular hardships are due to unique circumstances and are not generally applicable to other similarly situated property; and 5) the variation, if granted will not alter the essential character of the neighborhood; it is therefore

RESOLVED, that the Zoning Board of Appeals, by virtue of the authority conferred upon it, does hereby make a variation in the application of the district regulations of the zoning ordinance and that the aforesaid variation request be and it hereby is granted subject to the following condition(s):

That all applicable ordinances of the City of Chicago shall be complied with before a permit is issued.

APPROVED AS TO SUBSTANCE

[Signature]

CHAIRMAN

ZONING BOARD OF APPEALS, CITY OF CHICAGO, CITY HALL, ROOM 905

APPLICANT: Charles Patterson

CAL NO.: 100-19-Z

APPEARANCE FOR: Joe Gattuso

MINUTES OF MEETING:
February 15, 2019

APPEARANCE AGAINST: None

PREMISES AFFECTED: 1720 W. Balmoral Avenue

NATURE OF REQUEST: Application for a variation to increase the pre-existing floor area ratio by 447.18 square feet from 4,372.87 square feet to 4,820.05 square feet for a proposed rear two-story enclosed porch for the existing two-story, two dwelling unit building.

**ACTION OF BOARD-
VARIATION GRANTED**

THE VOTE

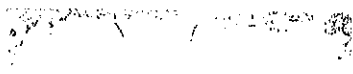
MAR 18 2019
 CITY OF CHICAGO
 ZONING BOARD OF APPEALS

SHAINA DOAR
SOL FLORES
SAM TOIA
AMANDA WILLIAMS

AFFIRMATIVE	NEGATIVE	ABSENT
X		
X		
X		
X		

THE RESOLUTION:

WHEREAS, a public hearing was held on this application by the Zoning Board of Appeals at its regular meeting held February 15, 2019 after due notice thereof as provided under Section 17-13-0107B and by publication in the Chicago Sun-Times on January 4, 2019; and

WHEREAS, the Zoning Board of Appeals, having reviewed the proposed finding of fact and having fully heard the testimony and arguments of the parties and being fully advised in the premises, hereby finds the following; the applicant shall be permitted to increase the pre-existing floor area ratio by 447.18 square feet to 4,820.05 square feet for a proposed rear two-story enclosed porch for the existing two-story, two dwelling unit building; two additional variations were granted to the subject property in Cal. Nos. 101-19-Z and 102-19-Z; the Board finds 1) strict compliance with the regulations and standards of this Zoning Ordinance would create practical difficulties or particular hardships for the subject property; 2) the requested variation is consistent with the stated purpose and intent of this Zoning Ordinance; 3) the property in question cannot yield a reasonable return if permitted to be used only in accordance with the standards of this Zoning Ordinance; 4) the practical difficulties or particular hardships are due to unique circumstances and are not generally applicable to other similarly situated property; and 5) the variation, if granted will not alter the essential character of the neighborhood; it is therefore

RESOLVED, that the Zoning Board of Appeals, by virtue of the authority conferred upon it, does hereby make a variation in the application of the district regulations of the zoning ordinance and that the aforesaid variation request be and it hereby is granted subject to the following condition(s):

That all applicable ordinances of the City of Chicago shall be complied with before a permit is issued.

APPROVED AS TO SUBSTANCE



 CHAIRMAN

ZONING BOARD OF APPEALS, CITY OF CHICAGO, CITY HALL, ROOM 905

APPLICANT: Charles Patterson **CAL NO.:** 101-19-Z
APPEARANCE FOR: Joe Gattuso **MINUTES OF MEETING:**
February 15, 2019
APPEARANCE AGAINST: None
PREMISES AFFECTED: 1720 W. Balmoral Avenue

NATURE OF REQUEST: Application for a variation to reduce the rear setback from the required 37.572' to 31.187', west setback from 2' to 0.281' (east to be 2.57'), combined side setback from 5' to 2.851' for a proposed enclosed porch on the existing two-story, two dwelling unit building.

**ACTION OF BOARD-
VARIATION GRANTED**

THE VOTE

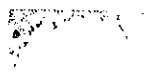
 MAR 18 2019
 CITY OF CHICAGO
 ZONING BOARD OF APPEALS

SHAINA DOAR
 SOL FLORES
 SAM TOIA
 AMANDA WILLIAMS

AFFIRMATIVE	NEGATIVE	ABSENT
X		
X		
X		
X		

THE RESOLUTION:

WHEREAS, a public hearing was held on this application by the Zoning Board of Appeals at its regular meeting held February 15, 2019 after due notice thereof as provided under Section 17-13-0107B and by publication in the Chicago Sun-Times on January 4, 2019; and

WHEREAS, the Zoning Board of Appeals, having reviewed the proposed finding of fact and having fully heard the testimony and arguments of the parties and being fully advised in the premises, hereby finds the following; the applicant shall be permitted to reduce the rear setback to 31.187', west setback to 0.281' (east to be 2.57'), combined side setback to 2.851' for a proposed enclosed porch on the existing two-story, two dwelling unit building; two additional variations were granted to the subject property in Cal. Nos. 100-19-Z and 102-19-Z; the Board finds 1) strict compliance with the regulations and standards of this Zoning Ordinance would create practical difficulties or particular hardships for the subject property; 2) the requested variation is consistent with the stated purpose and intent of this Zoning Ordinance; 3) the property in question cannot yield a reasonable return if permitted to be used only in accordance with the standards of this Zoning Ordinance; 4) the practical difficulties or particular hardships are due to unique circumstances and are not generally applicable to other similarly situated property; and 5) the variation, if granted will not alter the essential character of the neighborhood; it is therefore

RESOLVED, that the Zoning Board of Appeals, by virtue of the authority conferred upon it, does hereby make a variation in the application of the district regulations of the zoning ordinance and that the aforesaid variation request be and it hereby is granted subject to the following condition(s):

That all applicable ordinances of the City of Chicago shall be complied with before a permit is issued.

APPROVED AS TO SUBSTANCE

 CHAIRMAN

ZONING BOARD OF APPEALS, CITY OF CHICAGO, CITY HALL, ROOM 905

APPLICANT: Charles Patterson

CAL NO.: 102-19-Z

APPEARANCE FOR: Joe Gattuso

MINUTES OF MEETING:
February 15, 2019

APPEARANCE AGAINST: None

PREMISES AFFECTED: 1720 W. Balmoral Avenue

NATURE OF REQUEST: Application for a variation to reduce the rear yard open space from 450 square feet to 151 square feet for a proposed enclosed porch for the existing two-story, two dwelling unit building.

**ACTION OF BOARD-
VARIATION GRANTED**

THE VOTE

MAR 18 2019
CITY OF CHICAGO
ZONING BOARD OF APPEALS

SHAINA DOAR
SOL FLORES
SAM TOIA
AMANDA WILLIAMS

AFFIRMATIVE	NEGATIVE	ABSENT
X		
X		
X		
X		

THE RESOLUTION:

WHEREAS, a public hearing was held on this application by the Zoning Board of Appeals at its regular meeting held on February 15, 2019 after due notice thereof as provided under Section 17-13-0107B and by publication in the Chicago Sun-Times on January 4, 2019; and

WHEREAS, the Zoning Board of Appeals, having reviewed the proposed finding of fact and having fully heard the testimony and arguments of the parties and being fully advised in the premises, hereby finds the following; the applicant shall be permitted to reduce the rear yard open space to 151 square feet for a proposed enclosed porch for the existing two-story, two dwelling unit building; two additional variations were granted to the subject property in Cal. Nos. 100-19-Z and 101-19-Z; the Board finds 1) strict compliance with the regulations and standards of this Zoning Ordinance would create practical difficulties or particular hardships for the subject property; 2) the requested variation is consistent with the stated purpose and intent of this Zoning Ordinance; 3) the property in question cannot yield a reasonable return if permitted to be used only in accordance with the standards of this Zoning Ordinance; 4) the practical difficulties or particular hardships are due to unique circumstances and are not generally applicable to other similarly situated property; and 5) the variation, if granted will not alter the essential character of the neighborhood; it is therefore

RESOLVED, that the Zoning Board of Appeals, by virtue of the authority conferred upon it, does hereby make a variation in the application of the district regulations of the zoning ordinance and that the aforesaid variation request be and it hereby is granted subject to the following condition(s):

That all applicable ordinances of the City of Chicago shall be complied with before a permit is issued.

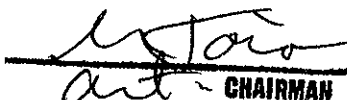
APPROVED AS TO SUBSTANCE

CHAIRMAN

ZONING BOARD OF APPEALS, CITY OF CHICAGO, CITY HALL, ROOM 905

APPLICANT: Richard and Laura Doyle

CAL NO.: 103-19-Z

APPEARANCE FOR: Sara Barnes

MINUTES OF MEETING:
February 15, 2019

APPEARANCE AGAINST: None

PREMISES AFFECTED: 4308 N. Kostner Avenue

NATURE OF REQUEST: Application for a variation to reduce the north setback from 5' to 1.42' (south setback to be 18.58') combined side set back shall be 20' for a proposed rear second floor addition to the existing two-story, single family residence.

**ACTION OF BOARD-
VARIATION GRANTED**

THE VOTE

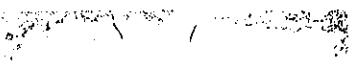

MAR 18 2019

CITY OF CHICAGO
ZONING BOARD OF APPEALS

SHAINA DOAR
SOL FLORES
SAM TOIA
AMANDA WILLIAMS

AFFIRMATIVE	NEGATIVE	ABSENT
X		
X		
		X
X		

THE RESOLUTION:

WHEREAS, a public hearing was held on this application by the Zoning Board of Appeals at its regular meeting held on February 15, 2019 after due notice thereof as provided under Section 17-13-0107B and by publication in the Chicago Tribune on January 4, 2019; and

WHEREAS, the Zoning Board of Appeals, having reviewed the proposed finding of fact and having fully heard the testimony and arguments of the parties and being fully advised in the premises, hereby finds the following; the applicant shall be permitted to reduce the north setback to 1.42' (south setback to be 18.58') combined side set back shall be 20' for a proposed rear second floor addition to the existing two-story, single family residence; the Board finds 1) strict compliance with the regulations and standards of this Zoning Ordinance would create practical difficulties or particular hardships for the subject property; 2) the requested variation is consistent with the stated purpose and intent of this Zoning Ordinance; 3) the property in question cannot yield a reasonable return if permitted to be used only in accordance with the standards of this Zoning Ordinance; 4) the practical difficulties or particular hardships are due to unique circumstances and are not generally applicable to other similarly situated property; and 5) the variation, if granted will not alter the essential character of the neighborhood; it is therefore

RESOLVED, that the Zoning Board of Appeals, by virtue of the authority conferred upon it, does hereby make a variation in the application of the district regulations of the zoning ordinance and that the aforesaid variation request be and it hereby is granted subject to the following condition(s):

That all applicable ordinances of the City of Chicago shall be complied with before a permit is issued.

APPROVED BY THE BOARD

[Signature]

CHAIRMAN

**ZONING BOARD OF APPEALS
CITY OF CHICAGO**

City Hall Room 905
121 North LaSalle Street
Chicago, Illinois 60602
TEL: (312) 744-3888



Eminent Living, LLC

APPLICANT

104-19-Z
CALENDAR NUMBER

4103 N. Mango Street

PREMISES AFFECTED

February 15, 2019

HEARING DATE

ACTION OF BOARD

THE VOTE

The application is denied for the reasons set forth in this decision.

Shaina Doar
Sol Flores
Sam Toia
Amanda Williams

AFFIRMATIVE	NEGATIVE	ABSENT
<input type="checkbox"/>	<input checked="" type="checkbox"/>	<input type="checkbox"/>
<input checked="" type="checkbox"/>	<input type="checkbox"/>	<input type="checkbox"/>
<input type="checkbox"/>	<input checked="" type="checkbox"/>	<input type="checkbox"/>
<input type="checkbox"/>	<input checked="" type="checkbox"/>	<input type="checkbox"/>

**FINDINGS OF THE ZONING BOARD OF APPEALS
IN THE MATTER OF THE VARIATION APPLICATION FOR 4103 N. MANGO
STREET BY EMINENT LIVING, LLC**

I. BACKGROUND

Eminent Living, LLC (the "Applicant") submitted a variation application for 4103 N. Mango Street (the "subject property"). The subject property is currently zoned RS-2 and is currently improved with a one-and-one-half story, two-dwelling unit building (the "building"). The Applicant proposed to erect a second floor addition to the building and deconvert the building into single-family residence. To permit this addition, the Applicant sought a variation to reduce: (1) the front setback from the required 20' to 18.87'; and (2) the north side setback from 5' to 1.54' (south side setback to be 28') for a combined side setback of 29.54'.

II. PUBLIC HEARING

A. The Hearing

The ZONING BOARD OF APPEALS held a public hearing on the Applicant's variation application at its regular meeting held on February 15, 2019, after due notice thereof as provided under Section 17-13-0107-B of the Chicago Zoning Ordinance and by publication in the *Chicago Sun-Times*. The Applicant's manager Mr. Michael Mathews was present. Testifying in opposition to the application was Mr. Christopher

APPROVED AS TO SUBSTANCE

CHAIRMAN

Yamaya, of 4106 N. Mango Street. In accordance with the ZONING BOARD OF APPEALS' Rules of Procedure, the Applicant had previously submitted its proposed Findings of Fact. The statements and testimony given during the public hearing were given in accordance with the ZONING BOARD OF APPEALS' Rules of Procedure.

B. Criteria for a Variation

Pursuant to Section 17-13-1107-A of the Chicago Zoning Ordinance, no variation application may be approved unless the ZONING BOARD OF APPEALS finds, based upon the evidence presented to it in each specific case, that: (1) strict compliance with the standards of the Chicago Zoning Ordinance would create practical difficulties or particular hardships; and (2) the requested variation is consistent with the stated purpose and intent of the Chicago Zoning Ordinance.

Pursuant to Section 17-13-1107-B of the Chicago Zoning Ordinance, in order to determine that practical difficulties or particular hardships exist, the ZONING BOARD OF APPEALS must find evidence of each of the following: (1) the property in question cannot yield a reasonable return if permitted to be used only in accordance with the standards of the Chicago Zoning Ordinance; (2) the practical difficulties or particular hardships are due to unique circumstances and are not generally applicable to other similarly situated property; and (3) the variation, if granted, will not alter the essential character of the neighborhood.

Pursuant to Section 17-13-1107-C of the Chicago Zoning Ordinance, in making its determination of whether practical difficulties or particular hardships exist, the ZONING BOARD OF APPEALS must take into consideration the extent to which evidence has been submitted substantiating the following facts: (1) the particular physical surroundings, shape or topographical condition of the specific property involved would result in a particular hardship upon the property owner as distinguished from a mere inconvenience, if the strict letter of the regulations were carried out; (2) the conditions upon which the petition for a variation is based would not be applicable, generally, to other property within the same zoning classification; (3) the purpose of the variation is not based exclusively upon a desire to make more money out of the property; (4) the alleged practical difficulty or particular hardship has not been created by any person presently having an interest in the property; (5) the granting of the variation will not be detrimental to the public welfare or injurious to other property or improvements in the neighborhood in which the property is located; and (6) the proposed variation will not impair an adequate supply of light and air to adjacent property, or substantially increase the congestion in the public streets, or increase the danger of fire, or endanger the public safety, or substantially diminish or impair property values within the neighborhood.

III. FINDINGS OF FACT.

After careful consideration of the evidence, testimony and the entire record, including the Applicant's proposed Findings of Fact, the ZONING BOARD OF APPEALS hereby makes the following findings with reference to the Applicant's applications for variations pursuant to Section 17-13-1107-A of the Chicago Zoning Ordinance:

1. *Strict compliance with the regulations and standards of the Chicago Zoning Ordinance would create practical difficulties or particular hardships for the subject property.*

Strict compliance with the regulations and standards of the Chicago Zoning Ordinance would not create practical difficulties or particular hardships for the subject property because, as will be discussed in more detail below, a practical difficulty or particular hardship does not mean one that is self-imposed, or that a piece of property is better adapted to a forbidden use than one which has permission, or that a variation would be to the owner's profit or advantage or convenience. *River Forest State Bank & Trust Co. v. Zoning Board of Appeals of Maywood*, 34 Ill.App.2d 412, 419 (1st Dist. 1961).

After careful consideration of the evidence, testimony and the entire record, including the Applicant's proposed Findings of Fact, the ZONING BOARD OF APPEALS hereby makes the following findings with reference to the Applicant's application for a variation pursuant to Section 17-13-1107-B of the Chicago Zoning Ordinance:

1. *The property in question cannot yield a reasonable return if permitted to be used only in accordance with the standards of the Chicago Zoning Ordinance.*

The Applicant presented one witness: Mr. Mathews. Mr. Mathews testified that if the subject property had to conform to the standards of the Chicago Zoning Ordinance, it would not be financially feasible for the Applicant to rehabilitate the subject property. However, it is also apparent from Mr. Mathews' testimony that the Applicant purchased the subject property with the sole intent of maximizing its return on its investment. This is therefore not a case of the subject property not being able to yield a reasonable rate of return but rather a case where the Applicant paid more for the subject property than it was worth as zoned. *Asbach v. Zoning Board of Appeals of the City of Chicago*, 133 Ill.App.2d 22, 24 (1st Dist. 1971),

2. *The practical difficulties or particular hardships are due to unique circumstances and are not generally applicable to other similarly situated property.*

The Applicant is attempting to maximize its profits on the subject property. This is not a unique circumstance but is instead a circumstance generally applicable to all developers when developing or redeveloping an investment property.

3. *The variation, if granted, will not alter the essential character of the neighborhood.*

The variation will allow the Applicant to construct a second floor addition to the subject property. Portage Park in general and this street in particular is characterized by traditional Chicago-style bungalows (i.e., one to one-and-a-half story). To allow the second story addition as contemplated by the Applicant would allow for a home that does not fit into this pattern of development. Thus, the variation, if granted, would alter the essential character of the neighborhood.

After careful consideration of the evidence, testimony and the entire record, including the Applicant's proposed Findings of Fact, the ZONING BOARD OF APPEALS hereby makes the following findings with reference to the Applicant's application for a variation pursuant to Section 17-13-1107-C of the Chicago Zoning Ordinance:

1. *The particular physical surroundings shape or topographical condition of the specific property involved would result in a particular hardship upon the property owner as distinguished from a mere inconvenience, if the strict letter of the regulations were carried out.*

There is nothing with respect to the particular physical surroundings, shape or topographical conditions of the subject property that would result in particular hardship upon the Applicant. Instead, in attempt to maximize its profits on the subject property, the Applicant illegally erected a second floor addition on the subject property.

2. *The conditions upon which the petition for the variation is based would not be applicable, generally, to other property within the same zoning classification.*

The Applicant seeks to maximize its profits with respect to its investment in the subject property. This is a condition applicable, generally, to any property within a RS-2 zoning classification.

3. *The purpose of the variation is not based exclusively upon a desire to make more money out of the property.*

Based on Mr. Mathews' testimony, it is apparent that the purpose of the variation is exclusively based upon a desire to make more money out of the subject property.

4. *The alleged practical difficulty or particular hardship has not been created by any person presently having an interest in the property.*

The Applicant began construction on the subject property without a building permit. Even assuming that the Applicant had received an easy permit¹ repair and

¹ Or, in the words of Mr. Mathews a repair and replace permit.

replace permit, an easy permit may not be used to tear off a roof and begin construction of a second floor addition. The Applicant therefore created its own hardship. To the extent that the Applicant now claims it cannot make a reasonable return on its investment in the subject property without the requested variation, such a claim cannot be considered a hardship as the Applicant and not the Chicago Zoning Ordinance created such alleged hardship. *Id.*

5. *The granting of the variation will not be detrimental to the public welfare or injurious to other property or improvements in the neighborhood in which the property is located.*

Granting the variation would allow the Applicant to finish an addition that it erected illegally. Allowing the Applicant to profit from its own illegal acts would be detrimental to the public welfare because due to the Applicant's lack of credibility, the ZONING BOARD OF APPEALS has no guarantee that the Applicant would abide by the Chicago Building Code in finishing the proposed addition.

IV. CONCLUSION

For all of these reasons, the ZONING BOARD OF APPEALS finds that the Applicant has not proved its case by evidence, testimony and the entire record, including the Applicant's proposed Findings of Fact and the Association's Statement of Opposition, covering the specific criteria for a variation pursuant to Sections 17-13-1107-A, B and C of the Chicago Zoning Ordinance.

The ZONING BOARD OF APPEALS hereby denies the Applicant's application for a variation.

This is a final decision subject to review under the Illinois Administrative Review Law, 735 ILCS 5/3-101 *et. seq.*

ZONING BOARD OF APPEALS, CITY OF CHICAGO, CITY HALL, ROOM 905

APPLICANT: Jared Sorkin, Voso, LLC

CAL NO.: 105-19-S

APPEARANCE FOR: Same as Applicant

MINUTES OF MEETING:
February 15, 2019

APPEARANCE AGAINST: None

PREMISES AFFECTED: 1902 W. Montrose Avenue*

NATURE OF REQUEST: Application for a special use to establish a barber shop.

**ACTION OF BOARD-
APPLICATION APPROVED**

THE VOTE

MAR 19 2019
CITY OF CHICAGO
ZONING BOARD OF APPEALS

SHAINA DOAR
SOL FLORES
SAM TOIA
AMANDA WILLIAMS

AFFIRMATIVE	NEGATIVE	ABSENT
		X
X		
X		
X		

THE RESOLUTION:

WHEREAS, a public hearing was held on this application by the Zoning Board of Appeals at its regular meeting held on February 15, 2019 after due notice thereof as provided under Section 17-13-0107B and by publication in the Chicago Tribune on January 4, 2019; and

WHEREAS, the Zoning Board of Appeals, having reviewed the proposed finding of fact and having fully heard the testimony and arguments of the parties and being fully advised in the premises, hereby finds the following; the applicant shall be permitted to establish a barber shop; further expert testimony was offered that the use complies with all of the criteria as set forth by the code for the granting of a special use at the subject site; the Board finds the use complies with all applicable standards of this Zoning Ordinance; is in the interest of the public convenience and will not have a significant adverse impact on the general welfare of neighborhood or community; is compatible with the character of the surrounding area in terms of site planning and building scale and project design; is compatible with the character of the surrounding area in terms of operating characteristics, such as hours of operation, outdoor lighting, noise, and traffic generation; and is designed to promote pedestrian safety and comfort; it is therefore

RESOLVED, that the aforesaid special use request be and it hereby is approved and the Zoning Administrator is authorized to permit said special use subject to the following condition(s): provided the special use is issued solely to the applicant, Jared Sorkin, Voso, LLC.

That all applicable ordinances of the City of Chicago shall be complied with before a permit is issued.

*Scrivener's Error

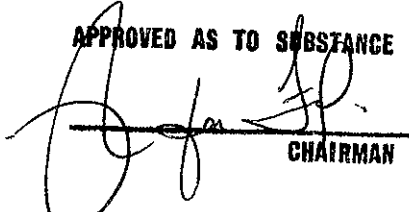
APPROVED AS TO SUBSTANCE

CHAIRMAN

ZONING BOARD OF APPEALS, CITY OF CHICAGO, CITY HALL, ROOM 905

APPLICANT: Board of Education

CAL NO.: 106-19-Z

APPEARANCE FOR: Scott Borstein

MINUTES OF MEETING:
February 15, 2019

APPEARANCE AGAINST: None

PREMISES AFFECTED: 4257 N. Tripp Avenue

NATURE OF REQUEST: Application for a variation to reduce the rear yard from the required 46.71' to 28.87' for two separate three-story upper building additions on an existing four-story school.

**ACTION OF BOARD-
VARIATION GRANTED**

THE VOTE



MAR 18 2019
CITY OF CHICAGO
ZONING BOARD OF APPEALS

SHAINA DOAR
SOL FLORES
SAM TOIA
AMANDA WILLIAMS

AFFIRMATIVE	NEGATIVE	ABSENT
		X
X		
X		
X		

THE RESOLUTION:

WHEREAS, a public hearing was held on this application by the Zoning Board of Appeals at its regular meeting held February 15, 2019 after due notice thereof as provided under Section 17-13-0107B and by publication in the Chicago Sun-Times on January 4, 2019; and

WHEREAS, the Zoning Board of Appeals, having reviewed the proposed finding of fact and having fully heard the testimony and arguments of the parties and being fully advised in the premises, hereby finds the following; the applicant shall be permitted to reduce the rear yard to 28.87' for two separate three-story upper building additions on an existing four-story school; an additional variation was granted to the subject property in Cal. No. 107-19-Z; the Board finds 1) strict compliance with the regulations and standards of this Zoning Ordinance would create practical difficulties or particular hardships for the subject property; 2) the requested variation is consistent with the stated purpose and intent of this Zoning Ordinance; 3) the property in question cannot yield a reasonable return if permitted to be used only in accordance with the standards of this Zoning Ordinance; 4) the practical difficulties or particular hardships are due to unique circumstances and are not generally applicable to other similarly situated property; and 5) the variation, if granted will not alter the essential character of the neighborhood; it is therefore

RESOLVED, that the Zoning Board of Appeals, by virtue of the authority conferred upon it, does hereby make a variation in the application of the district regulations of the zoning ordinance and that the aforesaid variation request be and it hereby is granted subject to the following condition(s):

That all applicable ordinances of the City of Chicago shall be complied with before a permit is issued.

APPROVED AS TO SUBSTANCE

[Signature]
CHAIRMAN

ZONING BOARD OF APPEALS, CITY OF CHICAGO, CITY HALL, ROOM 905

APPLICANT: Board of Education

CAL NO.: 107-19-Z

APPEARANCE FOR: Scott Borstein

MINUTES OF MEETING:
February 15, 2019

APPEARANCE AGAINST: None

PREMISES AFFECTED: 4257 N. Tripp Avenue

NATURE OF REQUEST: Application for a variation to increase the floor area ratio from 0.65 to 0.89 for two separate three story upper building additions to an existing four-story school building.

**ACTION OF BOARD-
VARIATION GRANTED**

THE VOTE

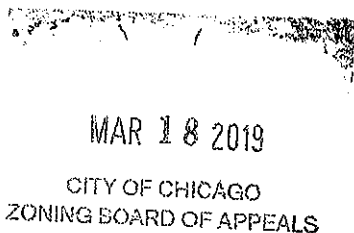

MAR 18 2019
CITY OF CHICAGO
ZONING BOARD OF APPEALS

SHAINA DOAR
SOL FLORES
SAM TOIA
AMANDA WILLIAMS

AFFIRMATIVE	NEGATIVE	ABSENT
		X
X		
X		
X		

THE RESOLUTION:

WHEREAS, a public hearing was held on this application by the Zoning Board of Appeals at its regular meeting held on February 15, 2019 after due notice thereof as provided under Section 17-13-0107B and by publication in the Chicago Sun-Times on January 4, 2019; and

WHEREAS, the Zoning Board of Appeals, having reviewed the proposed finding of fact and having fully heard the testimony and arguments of the parties and being fully advised in the premises, hereby finds the following; the applicant shall be permitted to increase the floor area ratio to 0.89 for two separate three story upper building additions to an existing four-story school building; an additional variation was granted to the subject property in Cal. No. 106-19-Z; the Board finds 1) strict compliance with the regulations and standards of this Zoning Ordinance would create practical difficulties or particular hardships for the subject property; 2) the requested variation is consistent with the stated purpose and intent of this Zoning Ordinance; 3) the property in question cannot yield a reasonable return if permitted to be used only in accordance with the standards of this Zoning Ordinance; 4) the practical difficulties or particular hardships are due to unique circumstances and are not generally applicable to other similarly situated property; and 5) the variation, if granted will not alter the essential character of the neighborhood; it is therefore

RESOLVED, that the Zoning Board of Appeals, by virtue of the authority conferred upon it, does hereby make a variation in the application of the district regulations of the zoning ordinance and that the aforesaid variation request be and it hereby is granted subject to the following condition(s):

That all applicable ordinances of the City of Chicago shall be complied with before a permit is issued.

APPROVED AS TO SUBSTANCE



CHAIRMAN

ZONING BOARD OF APPEALS, CITY OF CHICAGO, CITY HALL, ROOM 905

APPLICANT: Domingo Martinez

CAL NO.: 108-19-Z

APPEARANCE FOR: Same as Applicant

MINUTES OF MEETING:
February 15, 2019

APPEARANCE AGAINST: None

PREMISES AFFECTED: 5758 S. Hoyne Avenue

NATURE OF REQUEST: Application for a variation to reduce the north setback from the required 2.44' to 1.03' (south to be 7.5') combined side setback shall be 8.54' for a proposed two-story rear addition on the existing single family residence.

**ACTION OF BOARD-
VARIATION GRANTED**

THE VOTE

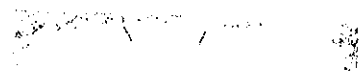
 MAR 18 2019
 CITY OF CHICAGO
 ZONING BOARD OF APPEALS

SHAINA DOAR
SOL FLORES
SAM TOIA
AMANDA WILLIAMS

AFFIRMATIVE	NEGATIVE	ABSENT
		X
X		
X		
X		

THE RESOLUTION:

WHEREAS, a public hearing was held on this application by the Zoning Board of Appeals at its regular meeting held February 15, 2019 after due notice thereof as provided under Section 17-13-0107B and by publication in the Chicago Sun-Times on January 4, 2019; and

WHEREAS, the Zoning Board of Appeals, having reviewed the proposed finding of fact and having fully heard the testimony and arguments of the parties and being fully advised in the premises, hereby finds the following; the applicant shall be permitted to reduce the north setback to 1.03' (south to be 7.5') combined side setback shall be 8.54' for a proposed two-story rear addition on the existing single family residence; the Board finds 1) strict compliance with the regulations and standards of this Zoning Ordinance would create practical difficulties or particular hardships for the subject property; 2) the requested variation is consistent with the stated purpose and intent of this Zoning Ordinance; 3) the property in question cannot yield a reasonable return if permitted to be used only in accordance with the standards of this Zoning Ordinance; 4) the practical difficulties or particular hardships are due to unique circumstances and are not generally applicable to other similarly situated property; and 5) the variation, if granted will not alter the essential character of the neighborhood; it is therefore

RESOLVED, that the Zoning Board of Appeals, by virtue of the authority conferred upon it, does hereby make a variation in the application of the district regulations of the zoning ordinance and that the aforesaid variation request be and it hereby is granted subject to the following condition(s):

That all applicable ordinances of the City of Chicago shall be complied with before a permit is issued.

APPROVED AS TO SUBSTANCE

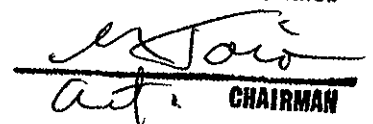
 CHAIRMAN

ZONING BOARD OF APPEALS, CITY OF CHICAGO, CITY HALL, ROOM 905

APPLICANT: Sawbill Properties, LLC (Series 2) **CAL NO.:** 109-19-Z

APPEARANCE FOR: Sara Barnes **MINUTES OF MEETING:**
February 15, 2019

APPEARANCE AGAINST: None

PREMISES AFFECTED: 1048-50 W. Cornelia Avenue

NATURE OF REQUEST: Application for a variation to reduce the rear setback from 30' to 18.21' for a proposed four-story, nine dwelling unit (one efficiency and eight dwelling units) building.

**ACTION OF BOARD-
VARIATION GRANTED**

THE VOTE

MAR 18 2019
CITY OF CHICAGO
ZONING BOARD OF APPEALS

SHAINA DOAR
SOL FLORES
SAM TOIA
AMANDA WILLIAMS

AFFIRMATIVE	NEGATIVE	ABSENT
X		
X		
X		
X		

THE RESOLUTION:

WHEREAS, a public hearing was held on this application by the Zoning Board of Appeals at its regular meeting held on February 15, 2019 after due notice thereof as provided under Section 17-13-0107B and by publication in the Chicago Sun-Times on January 4, 2019; and

WHEREAS, the Zoning Board of Appeals, having reviewed the proposed finding of fact and having fully heard the testimony and arguments of the parties and being fully advised in the premises, hereby finds the following; the applicant shall be permitted to reduce the rear setback to 18.21' for a proposed four-story, nine dwelling unit (one efficiency and eight dwelling units) building; the Board finds 1) strict compliance with the regulations and standards of this Zoning Ordinance would create practical difficulties or particular hardships for the subject property; 2) the requested variation is consistent with the stated purpose and intent of this Zoning Ordinance; 3) the property in question cannot yield a reasonable return if permitted to be used only in accordance with the standards of this Zoning Ordinance; 4) the practical difficulties or particular hardships are due to unique circumstances and are not generally applicable to other similarly situated property; and 5) the variation, if granted will not alter the essential character of the neighborhood; it is therefore

RESOLVED, that the Zoning Board of Appeals, by virtue of the authority conferred upon it, does hereby make a variation in the application of the district regulations of the zoning ordinance and that the aforesaid variation request be and it hereby is granted subject to the following condition(s):

That all applicable ordinances of the City of Chicago shall be complied with before a permit is issued.

APPROVED AS TO SUBSTANCE

[Signature]

CHAIRMAN

ZONING BOARD OF APPEALS, CITY OF CHICAGO, CITY HALL, ROOM 905

APPLICANT: CIBC Bank USA

CAL NO.: 110-19-S

APPEARANCE FOR: Thomas Goodwyn

MINUTES OF MEETING:
February 15, 2019

APPEARANCE AGAINST: None

PREMISES AFFECTED: 3010 S. Kedzie Avenue

NATURE OF REQUEST: Application for a special use to establish a three-lane drive through facility to serve an existing bank.

**ACTION OF BOARD-
APPLICATION APPROVED**

THE VOTE



MAR 18 2019
CITY OF CHICAGO
ZONING BOARD OF APPEALS

SHAINA DOAR
SOL FLORES
SAM TOIA
AMANDA WILLIAMS

AFFIRMATIVE	NEGATIVE	ABSENT
		X
X		
X		
X		

THE RESOLUTION:

WHEREAS, a public hearing was held on this application by the Zoning Board of Appeals at its regular meeting held February 15, 2019 after due notice thereof as provided under Section 17-13-0107B and by publication in the Chicago Tribune on January 4, 2019; and

WHEREAS, the Zoning Board of Appeals, having reviewed the proposed finding of fact and having fully heard the testimony and arguments of the parties and being fully advised in the premises, hereby finds the following; the applicant shall be permitted to establish a three-lane drive through facility to serve an existing bank; further expert testimony was offered that the use complies with all of the criteria as set forth by the code for the granting of a special use at the subject site; the Board finds the use complies with all applicable standards of this Zoning Ordinance; is in the interest of the public convenience and will not have a significant adverse impact on the general welfare of neighborhood or community; is compatible with the character of the surrounding area in terms of site planning and building scale and project design; is compatible with the character of the surrounding area in terms of operating characteristics, such as hours of operation, outdoor lighting, noise, and traffic generation; and is designed to promote pedestrian safety and comfort; it is therefore

RESOLVED, that the aforesaid special use request be and it hereby is approved and the Zoning Administrator is authorized to permit said special use subject to the following condition(s): provided the special use is issued solely to the applicant, CIBC Bank USA, and the development is consistent with the design and layout of the plans and drawings dated November 8, 2018, prepared by The Interior Design Group, Ltd.

That all applicable ordinances of the City of Chicago shall be complied with before a permit is issued.

APPROVED AS TO SUBSTANCE

[Signature]

[Signature] CHAIRMAN

ZONING BOARD OF APPEALS, CITY OF CHICAGO, CITY HALL, ROOM 905

APPLICANT: The Night Ministry

CAL NO.: 111-19-S

APPEARANCE FOR: Joe Gattuso

MINUTES OF MEETING:

February 15, 2019

APPEARANCE AGAINST: None

PREMISES AFFECTED: 1735 N. Ashland Avenue

NATURE OF REQUEST: Application for a special use to establish a temporary overnight shelter for up to twenty-five homeless youth on the first floor of an existing four-story commercial building.

ACTION OF BOARD-
Continued to March 15, 2019 at 9:00 a.m.

THE VOTE

MAR 18 2019
CITY OF CHICAGO
ZONING BOARD OF APPEALS

SHAINA DOAR
SOL FLORES
SAM TOIA
AMANDA WILLIAMS

AFFIRMATIVE	NEGATIVE	ABSENT
		X
X		
X		
X		

APPROVED AS TO SUBSTANCE

CHAIRMAN

ZONING BOARD OF APPEALS, CITY OF CHICAGO, CITY HALL, ROOM 905

APPLICANT: Modern Guapos Company

CAL NO.: 112-19-S

APPEARANCE FOR: Same as Applicant

MINUTES OF MEETING:
February 15, 2019

APPEARANCE AGAINST: None

PREMISES AFFECTED: 6020 S. Archer Avenue

NATURE OF REQUEST: Application for a special use to establish a barber shop.

**ACTION OF BOARD-
APPLICATION APPROVED**

THE VOTE

MAR 18 2019
CITY OF CHICAGO
ZONING BOARD OF APPEALS

SHAINA DOAR
SOL FLORES
SAM TOIA
AMANDA WILLIAMS

AFFIRMATIVE	NEGATIVE	ABSENT
		X
X		
X		
X		

THE RESOLUTION:

WHEREAS, a public hearing was held on this application by the Zoning Board of Appeals at its regular meeting held February 15, 2019 after due notice thereof as provided under Section 17-13-0107B and by publication in the Chicago Sun-Times on January 4, 2019; and

WHEREAS, the Zoning Board of Appeals, having reviewed the proposed finding of fact and having fully heard the testimony and arguments of the parties and being fully advised in the premises, hereby finds the following; the applicant shall be permitted to establish a barber shop; further expert testimony was offered that the use complies with all of the criteria as set forth by the code for the granting of a special use at the subject site; the Board finds the use complies with all applicable standards of this Zoning Ordinance; is in the interest of the public convenience and will not have a significant adverse impact on the general welfare of neighborhood or community; is compatible with the character of the surrounding area in terms of site planning and building scale and project design; is compatible with the character of the surrounding area in terms of operating characteristics, such as hours of operation, outdoor lighting, noise, and traffic generation; and is designed to promote pedestrian safety and comfort; it is therefore

RESOLVED, that the aforesaid special use request be and it hereby is approved and the Zoning Administrator is authorized to permit said special use subject to the following condition(s): provided the special use is issued solely to the applicant, Modern Guapos Company.

That all applicable ordinances of the City of Chicago shall be complied with before a permit is issued.

APPROVED AS TO SUBSTANCE

CHAIRMAN

ZONING BOARD OF APPEALS, CITY OF CHICAGO, CITY HALL, ROOM 905

APPLICANT: Kathy Hardin Earl dba Amani Maskani House, Inc. **CAL NO.:** 113-19-S

APPEARANCE FOR: Thomas Moore

MINUTES OF MEETING:
February 15, 2019

APPEARANCE AGAINST: None

PREMISES AFFECTED: 634 E. 72nd Street

NATURE OF REQUEST: Application for a special use to establish a transitional residence for up to ten adult female clients.

ACTION OF BOARD-
Continued to April 19, 2019 at 9:00 a.m.

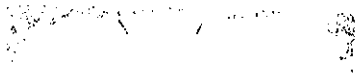

MAR 18 2019
CITY OF CHICAGO
ZONING BOARD OF APPEALS

THE VOTE

SHAINA DOAR
SOL FLORES
SAM TOIA
AMANDA WILLIAMS

AFFIRMATIVE	NEGATIVE	ABSENT
		X
X		
X		
X		

APPROVED AS TO SUBSTANCE

CHAIRMAN

APPLICANT: Sabrina Thomas dba Creative Handz Salon CAL NO.: 114-19-S

APPEARANCE FOR: Same as Applicant MINUTES OF MEETING:

February 15, 2019

APPEARANCE AGAINST: None

PREMISES AFFECTED: 10316 S. Halsted Street

NATURE OF REQUEST: Application for a special use to establish a hair and nail salon.

**ACTION OF BOARD-
APPLICATION APPROVED**

THE VOTE



SHAINA DOAR
SOL FLORES
SAM TOIA
AMANDA WILLIAMS

AFFIRMATIVE	NEGATIVE	ABSENT
X		
X		
		X
X		

THE RESOLUTION:

WHEREAS, a public hearing was held on this application by the Zoning Board of Appeals at its regular meeting held on February 15, 2019 after due notice thereof as provided under Section 17-13-0107B and by publication in the Chicago Sun-Times on January 4, 2019; and

WHEREAS, the Zoning Board of Appeals, having reviewed the proposed finding of fact and having fully heard the testimony and arguments of the parties and being fully advised in the premises, hereby finds the following; the applicant shall be permitted to establish a hair and nail salon; expert testimony was offered that the use would not have a negative impact on the surrounding community and is in character with the neighborhood; further expert testimony was offered that the use complies with all of the criteria as set forth by the code for the granting of a special use at the subject site; the Board finds the use complies with all applicable standards of this Zoning Ordinance; is in the interest of the public convenience and will not have a significant adverse impact on the general welfare of neighborhood or community; is compatible with the character of the surrounding area in terms of site planning and building scale and project design; is compatible with the character of the surrounding area in terms of operating characteristics, such as hours of operation, outdoor lighting, noise, and traffic generation; and is designed to promote pedestrian safety and comfort; it is therefore

RESOLVED, that the aforesaid special use request be and it hereby is approved and the Zoning Administrator is authorized to permit said special use subject to the following condition(s): provided the special use is issued solely to the applicant, Sabrina Thomas dba CREATIVE HANDZ SALON

Per Victor Rega

That all applicable ordinances of the City of Chicago shall be complied with before a permit is issued.

APPROVED AS TO SUBSTANCE

[Signature]
CHAIRMAN

ZONING BOARD OF APPEALS, CITY OF CHICAGO, CITY HALL, ROOM 905

APPLICANT: Sabrina Thomas dba Creative Handz Salon

CAL NO.: 114-19-S

APPEARANCE FOR: Same as Applicant

MINUTES OF MEETING:
February 15, 2019

APPEARANCE AGAINST: None

PREMISES AFFECTED: 10316 S. Halsted Street

NATURE OF REQUEST: Application for a special use to establish a hair and nail salon.

**ACTION OF BOARD-
APPLICATION APPROVED**

THE VOTE

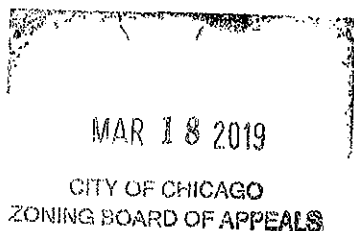

SHAINA DOAR
SOL FLORES
SAM TOIA
AMANDA WILLIAMS

AFFIRMATIVE	NEGATIVE	ABSENT
X		
X		
		X
X		

THE RESOLUTION:

WHEREAS, a public hearing was held on this application by the Zoning Board of Appeals at its regular meeting held on February 15, 2019 after due notice thereof as provided under Section 17-13-0107B and by publication in the Chicago Sun-Times on January 4, 2019; and

WHEREAS, the Zoning Board of Appeals, having reviewed the proposed finding of fact and having fully heard the testimony and arguments of the parties and being fully advised in the premises, hereby finds the following; the applicant shall be permitted to establish a hair and nail salon; expert testimony was offered that the use would not have a negative impact on the surrounding community and is in character with the neighborhood; further expert testimony was offered that the use complies with all of the criteria as set forth by the code for the granting of a special use at the subject site; the Board finds the use complies with all applicable standards of this Zoning Ordinance; is in the interest of the public convenience and will not have a significant adverse impact on the general welfare of neighborhood or community; is compatible with the character of the surrounding area in terms of site planning and building scale and project design; is compatible with the character of the surrounding area in terms of operating characteristics, such as hours of operation, outdoor lighting, noise, and traffic generation; and is designed to promote pedestrian safety and comfort; it is therefore

RESOLVED, that the aforesaid special use request be and it hereby is approved and the Zoning Administrator is authorized to permit said special use subject to the following condition(s): provided the special use is issued solely to the applicant, Sabrina Thomas.

That all applicable ordinances of the City of Chicago shall be complied with before a permit is issued.

APPROVED AS TO SUBSTANCE

[Signature]
CHAIRMAN

ZONING BOARD OF APPEALS, CITY OF CHICAGO, CITY HALL, ROOM 905

APPLICANT: Broadway 4437, LLC

CAL NO.: 115-19-Z

APPEARANCE FOR: Same as Applicant

MINUTES OF MEETING:
February 15, 2019

APPEARANCE AGAINST: None

PREMISES AFFECTED: 4437 N. Broadway

NATURE OF REQUEST: Application for a variation to reduce the required off-street parking space to zero to convert a commercial use to a mixed use with a general restaurant on the first and second floor and a one dwelling unit on the second floor in an existing two-story building.

**ACTION OF BOARD-
VARIATION GRANTED**

THE VOTE

MAR 18 2019
CITY OF CHICAGO
ZONING BOARD OF APPEALS

SHAINA DOAR
SOL FLORES
SAM TOIA
AMANDA WILLIAMS

AFFIRMATIVE	NEGATIVE	ABSENT
X		
X		
		X
X		

THE RESOLUTION:

WHEREAS, a public hearing was held on this application by the Zoning Board of Appeals at its regular meeting held on February 15, 2019 after due notice thereof as provided under Section 17-13-0107B and by publication in the Chicago Tribune on January 4, 2019; and

WHEREAS, the Zoning Board of Appeals, having reviewed the proposed finding of fact and having fully heard the testimony and arguments of the parties and being fully advised in the premises, hereby finds the following; the applicant shall be permitted to reduce the required off-street parking space to zero to convert a commercial use to a mixed use with a general restaurant on the first and second floor and a one dwelling unit on the second floor in an existing two-story building; the Board finds 1) strict compliance with the regulations and standards of this Zoning Ordinance would create practical difficulties or particular hardships for the subject property; 2) the requested variation is consistent with the stated purpose and intent of this Zoning Ordinance; 3) the property in question cannot yield a reasonable return if permitted to be used only in accordance with the standards of this Zoning Ordinance; 4) the practical difficulties or particular hardships are due to unique circumstances and are not generally applicable to other similarly situated property; and 5) the variation, if granted will not alter the essential character of the neighborhood; it is therefore

RESOLVED, that the Zoning Board of Appeals, by virtue of the authority conferred upon it, does hereby make a variation in the application of the district regulations of the zoning ordinance and that the aforesaid variation request be and it hereby is granted subject to the following condition(s):

That all applicable ordinances of the City of Chicago shall be complied with before a permit is issued.

APPROVED AS TO SUBSTANCE

[Signature]

CHAIRMAN

ZONING BOARD OF APPEALS, CITY OF CHICAGO, CITY HALL, ROOM 905

APPLICANT: Carlos Gutierrez **CAL NO.:** 116-19-Z
APPEARANCE FOR: Same as Applicant **MINUTES OF MEETING:**
February 15, 2019
APPEARANCE AGAINST: None
PREMISES AFFECTED: 2634 N. Rutherford Avenue

NATURE OF REQUEST: Application for a variation to reduce the south setback from the required 4' to zero, combined side setback from 7.5' to 1.31' to legalize an existing roof structure for the existing single family home.

**ACTION OF BOARD-
VARIATION GRANTED**

THE VOTE

MAR 18 2019
 CITY OF CHICAGO
 ZONING BOARD OF APPEALS

SHAINA DOAR
 SOL FLORES
 SAM TOIA
 AMANDA WILLIAMS

AFFIRMATIVE	NEGATIVE	ABSENT
X		
X		
X		
X		

THE RESOLUTION:

WHEREAS, a public hearing was held on this application by the Zoning Board of Appeals at its regular meeting held on February 15, 2019 after due notice thereof as provided under Section 17-13-0107B and by publication in the Chicago Sun-Times on January 4, 2019; and

WHEREAS, the Zoning Board of Appeals, having reviewed the proposed finding of fact and having fully heard the testimony and arguments of the parties and being fully advised in the premises, hereby finds the following; the applicant shall be permitted to reduce the south setback to zero, combined side setback to 1.31' to legalize an existing roof structure for the existing single family home; the Board finds 1) strict compliance with the regulations and standards of this Zoning Ordinance would create practical difficulties or particular hardships for the subject property; 2) the requested variation is consistent with the stated purpose and intent of this Zoning Ordinance; 3) the property in question cannot yield a reasonable return if permitted to be used only in accordance with the standards of this Zoning Ordinance; 4) the practical difficulties or particular hardships are due to unique circumstances and are not generally applicable to other similarly situated property; and 5) the variation, if granted will not alter the essential character of the neighborhood; it is therefore

RESOLVED, that the Zoning Board of Appeals, by virtue of the authority conferred upon it, does hereby make a variation in the application of the district regulations of the zoning ordinance and that the aforesaid variation request be and it hereby is granted subject to the following condition(s):

That all applicable ordinances of the City of Chicago shall be complied with before a permit is issued.

APPROVED AS TO SUBSTANCE

[Signature]
CHAIRMAN

ZONING BOARD OF APPEALS, CITY OF CHICAGO, CITY HALL, ROOM 905

APPLICANT: Zocalo Development, LLC-Morgan

CAL NO.: 117-19-Z

APPEARANCE FOR: Rolando Acosta

MINUTES OF MEETING:
February 15, 2019

APPEARANCE AGAINST: None

PREMISES AFFECTED: 1838 S. Morgan Street

NATURE OF REQUEST: Application for a variation to reduce the rear setback from 30' to 22.67' for a proposed roof deck on the existing garage with a new catwalk to connect the existing porch to the roof deck which will serve the existing three-story, two dwelling unit building.

**ACTION OF BOARD-
VARIATION GRANTED**

THE VOTE

MAR 18 2019
CITY OF CHICAGO
ZONING BOARD OF APPEALS

SHAINA DOAR
SOL FLORES
SAM TOIA
AMANDA WILLIAMS

AFFIRMATIVE	NEGATIVE	ABSENT
	X	
X		
X		
X		

THE RESOLUTION:

WHEREAS, a public hearing was held on this application by the Zoning Board of Appeals at its regular meeting held on February 15, 2019 after due notice thereof as provided under Section 17-13-0107B and by publication in the Chicago Tribune on January 4, 2019; and

WHEREAS, the Zoning Board of Appeals, having reviewed the proposed finding of fact and having fully heard the testimony and arguments of the parties and being fully advised in the premises, hereby finds the following; the applicant shall be permitted to reduce the rear setback to 22.67' for a proposed roof deck on the existing garage with a new catwalk to connect the existing porch to the roof deck which will serve the existing three-story, two dwelling unit building; the Board finds 1) strict compliance with the regulations and standards of this Zoning Ordinance would create practical difficulties or particular hardships for the subject property; 2) the requested variation is consistent with the stated purpose and intent of this Zoning Ordinance; 3) the property in question cannot yield a reasonable return if permitted to be used only in accordance with the standards of this Zoning Ordinance; 4) the practical difficulties or particular hardships are due to unique circumstances and are not generally applicable to other similarly situated property; and 5) the variation, if granted will not alter the essential character of the neighborhood; it is therefore

RESOLVED, that the Zoning Board of Appeals, by virtue of the authority conferred upon it, does hereby make a variation in the application of the district regulations of the zoning ordinance and that the aforesaid variation request be and it hereby is granted subject to the following condition(s):

That all applicable ordinances of the City of Chicago shall be complied with before a permit is issued.

APPROVED AS TO SUBSTANCE

[Signature]
CHAIRMAN

ZONING BOARD OF APPEALS, CITY OF CHICAGO, CITY HALL, ROOM 905

APPLICANT: SU Chaplin Chicago, LLC

CAL NO.: 118-19-Z

APPEARANCE FOR: Bernard Citron

MINUTES OF MEETING:
February 15, 2019

APPEARANCE AGAINST: None

PREMISES AFFECTED: 1749 W. Chicago Avenue

NATURE OF REQUEST: Application for a variation for an increase in height from the maximum 50' to 51.92' to replace a flat roof with a gabled roof on the existing building to be converted from four dwelling units with ground floor retail to six dwelling units with ground floor artist work / sales use.

**ACTION OF BOARD-
VARIATION GRANTED**

THE VOTE

MAR 18 2019
CITY OF CHICAGO
ZONING BOARD OF APPEALS

SHAINA DOAR
SOL FLORES
SAM TOIA
AMANDA WILLIAMS

AFFIRMATIVE	NEGATIVE	ABSENT
X		
X		
X		
X		

THE RESOLUTION:

WHEREAS, a public hearing was held on this application by the Zoning Board of Appeals at its regular meeting held on February 15, 2019 after due notice thereof as provided under Section 17-13-0107B and by publication in the Chicago Tribune on January 4, 2019; and

WHEREAS, the Zoning Board of Appeals, having reviewed the proposed finding of fact and having fully heard the testimony and arguments of the parties and being fully advised in the premises, hereby finds the following; the applicant shall be permitted to an increase in height from the maximum 50' to 51.92' to replace a flat roof with a gabled roof on the existing building to be converted from four dwelling units with ground floor retail to six dwelling units with ground floor artist work / sales use; the Board finds 1) strict compliance with the regulations and standards of this Zoning Ordinance would create practical difficulties or particular hardships for the subject property; 2) the requested variation is consistent with the stated purpose and intent of this Zoning Ordinance; 3) the property in question cannot yield a reasonable return if permitted to be used only in accordance with the standards of this Zoning Ordinance; 4) the practical difficulties or particular hardships are due to unique circumstances and are not generally applicable to other similarly situated property; and 5) the variation, if granted will not alter the essential character of the neighborhood; it is therefore

RESOLVED, that the Zoning Board of Appeals, by virtue of the authority conferred upon it, does hereby make a variation in the application of the district regulations of the zoning ordinance and that the aforesaid variation request be and it hereby is granted subject to the following condition(s):

That all applicable ordinances of the City of Chicago shall be complied with before a permit is issued.

APPROVED AS TO SUBSTANCE

[Signature]
CHAIRMAN

ZONING BOARD OF APPEALS, CITY OF CHICAGO, CITY HALL, ROOM 905

APPLICANT: SU Chaplin Chicago, LLC

CAL NO.: 119-19-Z

APPEARANCE FOR: Bernard Citron

MINUTES OF MEETING:
February 15, 2019

APPEARANCE AGAINST: None

PREMISES AFFECTED: 1749 W. Chicago Avenue

NATURE OF REQUEST: Application for a variation to reduce the required on site accessory parking from four parking spaces to three for an existing four-story mixed use building with four dwelling units with ground floor retail to be converted to six dwelling units with ground floor artist work / sales use.

**ACTION OF BOARD-
VARIATION WITHDRAWN**

THE VOTE

MAR 18 2019
CITY OF CHICAGO
ZONING BOARD OF APPEALS

SHAINA DOAR
SOL FLORES
SAM TOIA
AMANDA WILLIAMS

AFFIRMATIVE	NEGATIVE	ABSENT
X		
X		
X		
X		

APPROVED AS TO SUBSTANCE

CHAIRMAN

ZONING BOARD OF APPEALS
CITY OF CHICAGO

City Hall Room 905
121 North LaSalle Street
Chicago, Illinois 60602
TEL: (312) 744-3888



MAR 18 2019
CITY OF CHICAGO
ZONING BOARD OF APPEALS

Bronze Beauty Chicago, LLC – Jacquleen Crittle
APPLICANT

120-19-S
CALENDAR NUMBER

219 E. 31st Street
PREMISES AFFECTED

February 15, 2019
HEARING DATE

ACTION OF BOARD

THE VOTE

The application for the special use is approved subject to the conditions specified below.

Shaina Doar
Sol Flores
Sam Toia
Amanda Williams

AFFIRMATIVE	NEGATIVE	ABSENT
<input checked="" type="checkbox"/>	<input type="checkbox"/>	<input type="checkbox"/>
<input checked="" type="checkbox"/>	<input type="checkbox"/>	<input type="checkbox"/>
<input checked="" type="checkbox"/>	<input type="checkbox"/>	<input type="checkbox"/>
<input checked="" type="checkbox"/>	<input type="checkbox"/>	<input type="checkbox"/>

**FINDINGS OF THE ZONING BOARD OF APPEALS
IN THE MATTER OF THE SPECIAL USE APPLICATION FOR 219 E. 31ST
STREET BY BRONZE BEAUTY CHICAGO, LLC – JACQUELEENE CRITTLER**

I. BACKGROUND

Bronze Beauty Chicago, LLC – Jacquleen Crittle (the “Applicant”) submitted a special use application for 219 E. 31st Street (the “subject property”). The subject property is currently zoned B1-3 and is improved with four-story mixed-use building (the “building”). The Applicant currently operates a naturalist beauty supply store out of the building’s commercial space (the “store”). The Applicant proposed to establish a two-chair beauty salon at the rear of the store. To permit this two-chair beauty salon, the Applicant sought a special use. In accordance with Section 17-13-0903 of the Chicago Zoning Ordinance, the Zoning Administrator of the City’s Department of Planning and Development (“Zoning Administrator”) recommended approval of the special use provided that it was issued solely to the Applicant.

II. PUBLIC HEARING

A. The Hearing

The ZONING BOARD OF APPEALS held a public hearing on the Applicant’s special use application at its regular meeting held on February 15, 2019, after due notice thereof as provided under Section 17-13-0107-B of the Chicago Zoning Ordinance and by publication in the *Chicago Sun-Times*. In accordance with the ZONING BOARD OF APPEALS’ Rules of Procedure, the Applicant had submitted its proposed Findings of

APPROVED AS TO SUBSTANCE

CHAIRMAN

Fact. The Applicant's manager Ms. Jacqueline Crittle was present. Also testifying was the president of the GAP Community Organization Mr. Leonard M. McGee. Ms. Jeanette Velazquez appeared on behalf of the Department. The statements and testimony given during the public hearing were given in accordance with the ZONING BOARD OF APPEALS' Rules of Procedure.

B. Criteria for a Special Use

Pursuant to Section 17-13-0905-A of the Chicago Zoning Ordinance, no special use application may be approved unless the ZONING BOARD OF APPEALS finds that the proposed use in its proposed location meets all of the following criteria: (1) it complies with all applicable standards of the Chicago Zoning Ordinance; (2) it is in the interest of the public convenience and will not have a significant adverse impact on the general welfare of the neighborhood or community; (3) it is compatible with the character of the surrounding area in terms of site planning and building scale and project design; (4) is compatible with the character of the surrounding area in terms of operating characteristics, such as hours of operation, outdoor lighting, noise and traffic generation; and (5) it is designed to promote pedestrian safety and comfort.

III. FINDINGS OF FACT

After careful consideration of the evidence, testimony and the entire record, including the Applicant's proposed Findings of Fact, the ZONING BOARD OF APPEALS hereby makes the following findings with reference to the Applicant's application for a special use pursuant to Section 17-13-0905-A of the Chicago Zoning Ordinance:

1. *The proposed special use complies with all applicable standards of the Chicago Zoning Ordinance.*

The subject property is located in a B1-3 zoning district. Pursuant to Section 17-9-0112 of the Chicago Zoning Ordinance, a personal service use – such as the beauty salon the Applicant proposes – is a special use in any B district if it is located with 1000 feet of another personal service use. In this case, the subject property is located within 1000 feet of another beauty salon. The Applicant therefore requires a special use to establish its beauty salon. As the ZONING BOARD OF APPEALS has decided to grant the Applicant a special use, the proposed special use complies with all applicable standards of the Chicago Zoning Ordinance.

2. *The proposed special use is in the interest of the public convenience and will not have a significant adverse impact on the general welfare of the neighborhood or community.*

The proposed special use is in the interest of the public convenience in that it will allow the Applicant to provide an additional service in its store. As Ms. Crittle very credibly testified, the Applicant currently provides natural hair products as

well as natural hair educational seminars. The proposed special use will allow the Applicant to provide for hair-styling as well. The proposed special use will not have a significant adverse impact on the general welfare of the neighborhood as it will be located in the rear of the Applicant's store and will be complementary to the Applicant's existing business.

3. *The proposed special use is compatible with the character of the surrounding area in terms of site planning and building scale and project design.*

The proposed special use is compatible with the character of the surrounding area in terms of site planning and building scale and project design because, as noted above, it will be located in the rear of the Applicant's store.

4. *The proposed special use is compatible with the character of the surrounding area in terms of operating characteristics, such as hours of operation, outdoor lighting, noise and traffic generation.*

The proposed special use is compatible with the character of the surrounding area in terms of operating characteristics, such as hours of operation, outdoor lighting, noise and traffic generation because it will be located at the rear of the Applicant's store. It therefore will not cause any noise or outdoor lighting issues. Moreover, the hours of operation as testified to by Ms. Crittle are perfectly compatible with a business district as would be any additional traffic generated by this additional use to the Applicant's existing business.

5. *The proposed special use is designed to promote pedestrian safety and comfort.*

As noted above, the proposed special use will be located in the rear of the Applicant's store. It will therefore have no negative impact on pedestrian safety and comfort.

IV. CONCLUSION

For all of these reasons, the ZONING BOARD OF APPEALS finds that the Applicant has proved its case by evidence, testimony and the entire record, including the Applicant's proposed Findings of Fact, covering the specific criteria for a special use pursuant to Section 17-13-0905-A of the Chicago Zoning Ordinance.

The ZONING BOARD OF APPEALS hereby approves the Applicant's application for a special use, and pursuant to the authority granted to the ZONING BOARD OF APPEALS by Section 17-13-906 of the Chicago Zoning Ordinance, the Zoning Administrator is authorized to permit said special use subject to the following conditions:

1. The special use shall be issued solely to the Applicant; and

2. Development shall be consistent with those plans submitted by the Applicant to the ZONING BOARD OF APPEALS as part of the Applicant's application and which show two (2) chairs.

This is a final decision subject to review under the Illinois Administrative Review Law, 735 ILCS 5/3-101 *et seq.*

ZONING BOARD OF APPEALS, CITY OF CHICAGO, CITY HALL, ROOM 905

APPLICANT: Chicago Title Land Trust Company as trustee under Trust No. 8002378072, dated 5/17/18

CAL NO.: 121-19-Z

APPEARANCE FOR: Tyler Manic

MINUTES OF MEETING:
February 15, 2019

APPEARANCE AGAINST: None

PREMISES AFFECTED: 2930 N. Lakewood Avenue

NATURE OF REQUEST: Application for a variation to reduce the front setback from the required 10.29' to 8.58', rear setback from 24.01' to 10.8' for a proposed two-story, single family residence with an attached two car garage, rooftop stairway enclosure, decks and balcony.

**ACTION OF BOARD-
VARIATION GRANTED**

THE VOTE



SHAINA DOAR
SOL FLORES
SAM TOIA
AMANDA WILLIAMS

AFFIRMATIVE	NEGATIVE	ABSENT
X		
X		
		X
X		

THE RESOLUTION:

WHEREAS, a public hearing was held on this application by the Zoning Board of Appeals at its regular meeting held on February 15, 2019 after due notice thereof as provided under Section 17-13-0107B and by publication in the Chicago Times on January 4, 2019; and

WHEREAS, the Zoning Board of Appeals, having reviewed the proposed finding of fact and having fully heard the testimony and arguments of the parties and being fully advised in the premises, hereby finds the following; the applicant shall be permitted to reduce the front setback to 8.58', rear setback to 10.8' for a proposed two-story, single family residence with an attached two car garage, rooftop stairway enclosure, decks and balcony; an additional variation was granted to the subject property in Cal. No. 122-19-Z; the Board finds 1) strict compliance with the regulations and standards of this Zoning Ordinance would create practical difficulties or particular hardships for the subject property; 2) the requested variation is consistent with the stated purpose and intent of this Zoning Ordinance; 3) the property in question cannot yield a reasonable return if permitted to be used only in accordance with the standards of this Zoning Ordinance; 4) the practical difficulties or particular hardships are due to unique circumstances and are not generally applicable to other similarly situated property; and 5) the variation, if granted will not alter the essential character of the neighborhood; it is therefore

RESOLVED, that the Zoning Board of Appeals, by virtue of the authority conferred upon it, does hereby make a variation in the application of the district regulations of the zoning ordinance and that the aforesaid variation request be and it hereby is granted subject to the following condition(s):

That all applicable ordinances of the City of Chicago shall be complied with before a permit is issued.

APPROVED AS TO SUBSTANCE



 CHAIRMAN

ZONING BOARD OF APPEALS, CITY OF CHICAGO, CITY HALL, ROOM 905

APPLICANT: Chicago Title Land Trust Company as trustee under Trust No. 8002378072, dated 5/17/18

CAL NO.: 122-19-Z

APPEARANCE FOR: Tyler Manic

MINUTES OF MEETING:
February 15, 2019

APPEARANCE AGAINST: None

PREMISES AFFECTED: 2930 N. Lakewood Avenue

NATURE OF REQUEST: Application for a variation to relocate the rear yard open space to a proposed garage roof deck which will serve the proposed two-story, single family residence.

**ACTION OF BOARD-
VARIATION GRANTED**

THE VOTE

MAR 18 2019
CITY OF CHICAGO
ZONING BOARD OF APPEALS

SHAINA DOAR
SOL FLORES
SAM TOIA
AMANDA WILLIAMS

AFFIRMATIVE	NEGATIVE	ABSENT
X		
X		
		X
X		

THE RESOLUTION:

WHEREAS, a public hearing was held on this application by the Zoning Board of Appeals at its regular meeting held on February 15, 2019 after due notice thereof as provided under Section 17-13-0107B and by publication in the Chicago Sun-Times on January 4, 2019; and

WHEREAS, the Zoning Board of Appeals, having reviewed the proposed finding of fact and having fully heard the testimony and arguments of the parties and being fully advised in the premises, hereby finds the following; the applicant shall be permitted to relocate the rear yard open space to a proposed garage roof deck which will serve the proposed two-story, single family residence; an additional variation was granted to the subject property in Cal. No. 121-19-Z; the Board finds 1) strict compliance with the regulations and standards of this Zoning Ordinance would create practical difficulties or particular hardships for the subject property; 2) the requested variation is consistent with the stated purpose and intent of this Zoning Ordinance; 3) the property in question cannot yield a reasonable return if permitted to be used only in accordance with the standards of this Zoning Ordinance; 4) the practical difficulties or particular hardships are due to unique circumstances and are not generally applicable to other similarly situated property; and 5) the variation, if granted will not alter the essential character of the neighborhood; it is therefore

RESOLVED, that the Zoning Board of Appeals, by virtue of the authority conferred upon it, does hereby make a variation in the application of the district regulations of the zoning ordinance and that the aforesaid variation request be and it hereby is granted subject to the following condition(s):

That all applicable ordinances of the City of Chicago shall be complied with before a permit is issued.

APPROVED AS TO SUBSTANCE

[Signature]

CHAIRMAN

ZONING BOARD OF APPEALS, CITY OF CHICAGO, CITY HALL, ROOM 905

APPLICANT: Marc Lifshin

CAL NO.: 123-19-Z

APPEARANCE FOR: Rolando Acosta

MINUTES OF MEETING:
February 15, 2019

APPEARANCE AGAINST: None

PREMISES AFFECTED: 1921 N. Wolcott Avenue

NATURE OF REQUEST: Application for a variation to reduce the north setback from the required 4' to 1' (south to be 2') combined side setback from 10' to 3' for a proposed two story addition and a raised rear patio on the existing three-story, single family residence.

**ACTION OF BOARD-
VARIATION GRANTED**

THE VOTE

MAR 18 2019
CITY OF CHICAGO
ZONING BOARD OF APPEALS

SHAINA DOAR
SOL FLORES
SAM TOIA
AMANDA WILLIAMS

AFFIRMATIVE	NEGATIVE	ABSENT
X		
X		
X		
X		

THE RESOLUTION:

WHEREAS, a public hearing was held on this application by the Zoning Board of Appeals at its regular meeting held on February 15, 2019 after due notice thereof as provided under Section 17-13-0107B and by publication in the Chicago Sun-Times on January 4, 2019; and

WHEREAS, the Zoning Board of Appeals, having reviewed the proposed finding of fact and having fully heard the testimony and arguments of the parties and being fully advised in the premises, hereby finds the following; the applicant shall be permitted to reduce the north setback to 1' (south to be 2') combined side setback to 3' for a proposed two story addition and a raised rear patio on the existing three-story, single family residence; the Board finds 1) strict compliance with the regulations and standards of this Zoning Ordinance would create practical difficulties or particular hardships for the subject property; 2) the requested variation is consistent with the stated purpose and intent of this Zoning Ordinance; 3) the property in question cannot yield a reasonable return if permitted to be used only in accordance with the standards of this Zoning Ordinance; 4) the practical difficulties or particular hardships are due to unique circumstances and are not generally applicable to other similarly situated property; and 5) the variation, if granted will not alter the essential character of the neighborhood; it is therefore

RESOLVED, that the Zoning Board of Appeals, by virtue of the authority conferred upon it, does hereby make a variation in the application of the district regulations of the zoning ordinance and that the aforesaid variation request be and it hereby is granted subject to the following condition(s):

That all applicable ordinances of the City of Chicago shall be complied with before a permit is issued.

APPROVED AS TO SUBSTANCE

[Signature]

CHAIRMAN

ZONING BOARD OF APPEALS, CITY OF CHICAGO, CITY HALL, ROOM 905

APPLICANT: 1351 Damen, LLC

CAL NO.: 124-19-Z

APPEARANCE FOR: Elizabeth Santis

MINUTES OF MEETING:

February 15, 2019

APPEARANCE AGAINST: None

PREMISES AFFECTED: 1351 N. Damen Avenue

NATURE OF REQUEST: Application for a variation to reduce the rear setback from the required 22.5' to .25', south setback from 4.44' to .25' (north to be zero as allowed for an abutting alley) for a proposed one-story attached three car garage with roof deck to serve the existing four-story, three dwelling unit building.

ACTION OF BOARD-

Continued to April 19, 2019 at 9:00 a.m.

THE VOTE

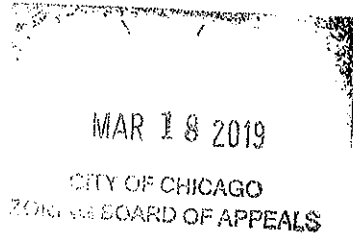

SHAINA DOAR
SOL FLORES
SAM TOIA
AMANDA WILLIAMS

AFFIRMATIVE	NEGATIVE	ABSENT
X		
		X
X		
X		

APPROVED AS TO SUBSTANCE

CHAIRMAN

ZONING BOARD OF APPEALS, CITY OF CHICAGO, CITY HALL, ROOM 905

APPLICANT: Premise to Premise, LLC

CAL NO.: 125-19-Z

APPEARANCE FOR: Same as Applicant

MINUTES OF MEETING:
February 15, 2019

APPEARANCE AGAINST: None

PREMISES AFFECTED: 3609 W. North Avenue

NATURE OF REQUEST: Application for a variation to establish a public place of amusement license to provide event space/gaming lounge (live entertainment, music, entrance fee) offering virtual games, console game tables and pool which is located within 125' of a residential district.

**ACTION OF BOARD-
VARIATION GRANTED WITH CONDITIONS**

THE VOTE

MAR 18 2019
CITY OF CHICAGO
ZONING BOARD OF APPEALS

SHAINA DOAR
SOL FLORES
SAM TOIA
AMANDA WILLIAMS

AFFIRMATIVE	NEGATIVE	ABSENT
X		
X		
X		
X		

THE RESOLUTION:

WHEREAS, a public hearing was held on this application by the Zoning Board of Appeals at its regular meeting held February 15, 2019 after due notice thereof as provided under Section 17-13-0107B and by publication in the Chicago Tribune on January 4, 2019; and

WHEREAS, the Zoning Board of Appeals, having reviewed the proposed finding of fact and having fully heard the testimony and arguments of the parties and being fully advised in the premises, hereby finds the following; the applicant shall be permitted to establish a public place of amusement license to provide event space/gaming lounge (live entertainment, music, entrance fee) offering virtual games, console game tables and pool which is located within 125' of a residential district; the Board finds 1) strict compliance with the regulations and standards of this Zoning Ordinance would create practical difficulties or particular hardships for the subject property; 2) the requested variation is consistent with the stated purpose and intent of this Zoning Ordinance; 3) the property in question cannot yield a reasonable return if permitted to be used only in accordance with the standards of this Zoning Ordinance; 4) the practical difficulties or particular hardships are due to unique circumstances and are not generally applicable to other similarly situated property; and 5) the variation, if granted will not alter the essential character of the neighborhood; it is therefore

RESOLVED, that the Zoning Board of Appeals, by virtue of the authority conferred upon it, does hereby make a variation in the application of the district regulations of the zoning ordinance and that the aforesaid variation request be and it hereby is granted subject to the following condition(s): provided applicant, Premise to Premise shall have a Security Guard when open to the public.

That all applicable ordinances of the City of Chicago shall be complied with before a permit is issued.

APPROVED AS TO SUBSTANCE
[Signature]
CHAIRMAN

**ZONING BOARD OF APPEALS
CITY OF CHICAGO**

City Hall Room 905
121 North LaSalle Street
Chicago, Illinois 60602
TEL: (312) 744-3888



Zoom Properties Hermitage, LLC
APPELLANT

126-19-A
CALENDAR NUMBER

1926 N. Hermitage Avenue
PREMISES AFFECTED

February 15, 2019
HEARING DATE

ACTION OF BOARD

THE VOTE

The decision of the Zoning Administrator is affirmed.

Shaina Doar
Sol Flores
Sam Toia
Amanda Williams

AFFIRMED	REVERSED	ABSENT
<input checked="" type="checkbox"/>	<input type="checkbox"/>	<input type="checkbox"/>
<input checked="" type="checkbox"/>	<input type="checkbox"/>	<input type="checkbox"/>
<input checked="" type="checkbox"/>	<input type="checkbox"/>	<input type="checkbox"/>
<input checked="" type="checkbox"/>	<input type="checkbox"/>	<input type="checkbox"/>

**FINDINGS OF THE ZONING BOARD OF APPEALS
IN THE MATTER OF THE APPEAL OF A DECISION BY THE ZONING
ADMINISTRATOR BY ZOOM PROPERTIES HERMITAGE, LLC**

I. BACKGROUND

Zoom Properties Hermitage, LLC (the "Appellant") owns 1926 N. Hermitage (the "subject property"). The subject property is located in a RS-3 zoning district and is improved with a three-story building ("building"). In October 2018, the Appellant contracted to sell the subject property. Pursuant to Section 3-33-045 of the Municipal Code of the City of Chicago ("MCC"), the Appellant applied for a certificate of zoning compliance from the City's Department of Planning and Development's Office of the Zoning Administrator (the "Zoning Administrator"). Although the Appellant requested that the Zoning Administrator certify that the building had three legal dwelling units, the Zoning Administrator denied such certification. Pursuant to Section 3-33-045(E) of the MCC, the Appellant requested that the Zoning Administrator reconsider such denial. Upon reconsideration, the Zoning Administrator reaffirmed its denial on December 11,

APR 22 2019

CITY OF CHICAGO
ZONING BOARD OF APPEALS

APPROVED AS TO SUBSTANCE

CHAIRMAN

2018 (the “2018 Zoning Certificate”).¹ Pursuant to Section 17-13-1201 of the MCC, the Appellant then appealed the 2018 Zoning Certificate to the Zoning Board of Appeals.²

II. PUBLIC HEARING

A. The Hearing

The ZONING BOARD OF APPEALS held a public hearing on the Appellant’s appeal at its regular meeting of February 15, 2019, after due notice thereof as provided under Section 17-13-1206 of the MCC. One of the Appellant’s managers Mr. Corey Brenner was present. The Appellant’s attorney Mr. Tyler Manic was present. The Appellant’s architect Mr. Artur Kaczmarek and its real estate broker Ms. Karen Biazar were also present. The Assistant Zoning Administrator Steven Valenziano was present. The statements and testimony given during the public hearing were given in accordance with the ZONING BOARD OF APPEALS’ Rules of Procedure.

The Appellant’s attorney Mr. Tyler Manic made his opening argument. He argued that the building on the subject property had contained three dwelling units prior to 1957 and therefore the third dwelling unit did not need – as the Zoning Administrator had stated on the 2018 Zoning Certificate – a permit for its establishment.³ He argued that the records upon which the Zoning Administrator had relied when issuing the 2018 Zoning Certificate – especially the Department of Public Works’ annual examination records (“Water Records”) – were hearsay⁴ and did not specifically address dwelling units. He argued that there were other records with respect to the subject property, including a certificate of zoning compliance issued by the Zoning Administrator in 2012 which had certified that the building on the subject property contained three legal dwelling units (the “2012 Zoning Certificate”). He argued that such other records should have been given the same weight and credibility by the Zoning Administrator as the

¹ Specifically, Assistant Zoning Administrator Steven Valenziano issued the following written statement: “Dept. Pub. Works Record #2279 2 DUs in 1949. Subsequent permits #263885 (1959) & 774558 (1993) show 2 DUs. No Permit Record to Establish 3rd Unit.”

² Although the Appellant submitted to the ZONING BOARD OF APPEALS portions of the MCC relating to administrative adjustments with certain sections – notably, Sections 17-13-1003-BB and 17-13-1007-B, the Appellant did not seek such administrative adjustment prior to coming before the ZONING BOARD OF APPEALS. Therefore, unlike most appeals that come before the ZONING BOARD OF APPEALS, there is no administrative adjustment file for the ZONING BOARD OF APPEALS to review. Instead, there is only what Assistant Zoning Administrator Steven Valenziano reviewed when rendering the 2018 Zoning Certificate.

³ As such third dwelling unit would be a legal nonconforming use pursuant to Section 17-15-0301 of the MCC.

⁴ The ZONING BOARD OF APPEALS notes that “the strict rules of evidence that apply in a judicial proceeding are not applicable to proceedings before an administrative agency.” *Jimble v. Ill. State Bd. of Educ.*, 2014 IL App (1st) 123436 (July 18, 2014), ¶79; *see also MJ Ontario, Inc. v. Daley*, 371 Ill.App.3d 140, 149 (1st Dist. 2007). A zoning board of appeals is an administrative agency. *Ill. Bell Tel. Co. v. Fox*, 402 Ill. 617 (1949). Further, the Water Records entered into the ZONING BOARD OF APPEALS’ file by the Zoning Administrator in this matter are records that are kept in the City’s regularly conducted course of business as testified to by Mr. Valenziano. Thus such records are exceptions to hearsay. *Ill. R. Evid.* 803(6) (eff. Sept. 28, 2018).

Water Records, especially as none of the records – save the 2012 Zoning Certificate – are specifically records that determine dwelling unit count. He argued that based on the 2012 Zoning Certificate, the Zoning Administrator was now estopped from denying that there were three legal dwelling units on the subject property. He conceded that while the Zoning Administrator had the authority to revoke any zoning certificate based on any incorrect information,⁵ that was not the case in this instance as there was no incorrect information on the 2012 Zoning Certificate.

In response to Mr. Manic's estoppel argument, the ZONING BOARD OF APPEALS reminded Mr. Manic that the ZONING BOARD OF APPEALS was not a board of equity.

The Appellant presented the testimony of its architect Mr. Artur Kaczmarek. Mr. Kaczmarek testified that the scope of his assignment from the Appellant had been to verify how many dwelling units were original to the building. He testified that based on his inspection of the building, his opinion was that the location and layouts of the three dwelling units seemed to be unchanged from the time of the building's original establishment. He testified that he had prepared a report detailing these opinions.

The Appellant presented the testimony of one of its managers Mr. Corey Brenner. Mr. Brenner testified that the Appellant had owned the subject property since 2012. He testified that when the Appellant purchased the subject property, he had believed there were three legal dwelling units. He testified that at the time the Appellant had purchased the subject property, all three dwelling units had been rented. He testified that the Appellant had received the 2012 Zoning Certificate confirming the three legal dwelling units. He testified that the Appellant had not added any square footage, dwelling units, kitchens or bathrooms to the building. He testified that the Appellant had continuously rented out all three dwelling units. He testified that the Appellant had attempted to sell the subject property and had received an offer. He testified, however, that the Appellant had not been able to sell the subject property due to the Appellant's inability to receive a certificate of zoning compliance for the subject property that certified the building had three legal dwelling units.

The ZONING BOARD OF APPEALS then asked questions of the Appellant's witnesses. In particular, Mr. Kazmarek testified that dormers had been added to the top floor of the building. He testified that while he could not definitively state when such dormers had been added, it was definitely later than the 1950s.

The Appellant presented the testimony of its real estate broker Ms. Karen Biazar. She testified that the scope of her assignment from the Appellant was to provide a valuation opinion contrasting the building's value as a two dwelling unit building with the building's value as a three dwelling unit building.

⁵ The reverse side of every zoning certificate issued by the Zoning Administrator states that: "The Zoning Administrator reserves the right to reconsider and revoke any Certificate of Zoning Compliance issued based on false or otherwise incorrect information provided by the Applicant."

The ZONING BOARD OF APPEALS asked the relevance of Ms. Biazar's testimony. It again reminded that it was not a board of equity.

Ms. Biazar then testified that it was her opinion that the building on the subject property was much more valuable as a three dwelling unit building.

The Zoning Administrator presented the testimony of the Assistant Zoning Administrator Mr. Steven Valenziano. Mr. Valenziano testified that the 2012 Zoning Certificate had been issued in error. He testified that he believed the 2012 Zoning Certificate had been issued in reliance on the 2010 building permit. He testified that because this 2010 building permit had been a so-called "Easy Permit," such permit had never gone through proper zoning review. He testified that the examiner that had issued the 2012 Zoning Certificate has since retired. He testified that when the Appellant had applied for a certificate of zoning compliance in October 2018, the new examiner researched the issue and realized that the 2010 building permit had been an Easy Permit. He testified that the examiner had also found evidence that the building was only a two unit building. He testified that therefore the examiner denied the request to certify the subject property for three legal dwelling units. He testified that the Appellant then requested that such denial be reconsidered. He testified that a reconsideration brings the matter to his desk.

He testified that he reviewed all the documents in the City's possession. He testified that Mr. Manic was correct with respect to the fact that prior to 1957 there was no minimum lot area requirement for zoning districts. He testified that instead there were volume districts and use districts. He testified that in 1957 minimum lot area requirement rules went into place. He testified that the City's Department of Planning and Development has therefore historically relied upon the Water Records. He testified that the City's (former) Department of Public Works would go out annually and look at each building in the City and record how many bathrooms, how many toilets, how many sinks, how many families and how many floors a building had. He testified that in this case, he reviewed the 1949 annual examination records ("1949 Water Records"). He testified that he did not know if the 1949 Water Records were part of Mr. Manic's submissions to the ZONING BOARD OF APPEALS but such 1949 Water Records were in the ZONING BOARD OF APPEALS' file. He testified that with respect to the subject property, the 1949 Water Records show that the subject property in 1949 was improved with a two-story building. He testified that on the first floor of the building, there was one family with six members, one water closet, one bathroom and one sink. He testified that on the second floor of the building, there was one family with five members, one water closet, one bathroom and one sink. He testified that therefore, in 1949, the subject property was improved with a two-story building with two dwelling units.

He testified that he then looked at the City's Sanborn Fire Insurance Maps. He testified that he believed that the relevant portions of the City's volumes of the Sanborn Fire Insurance Maps also date from 1949. He briefly explained the history of Sanborn Fire Insurance Maps and then stated that the Sanborn Fire Insurance Maps depict the subject property as improved with a two-and-a-half story building.

He testified that as part of his reconsideration, he then looked at a 1993 building permit issued by the City's Department of Buildings. He testified the applicant for the 1993 building permit had stated on the first page of the building permit application that the building had two dwelling units. He testified that this 1993 building permit had gone through zoning review⁶ and was confirmed to contain two dwelling units. He testified that with respect to the 2010 Easy Permit, which did not go through zoning review, the applicant for the 2010 Easy Permit application had stated that the building contained three dwelling units. He testified that there were various building violations prior to 2010 for the buildings and that the 2010 Easy Permit was to allow these violations to be repaired. He testified that the 2010 Easy Permit would not have allowed a conversion or establishment of a new dwelling unit in the building. He testified that there is no permit and no record of a permit establishing the third dwelling unit. He testified that there is no permit and no record of permit establishing the dormers.

He testified that if one looked at the photographs provided by the Appellant of the building, one could see the original roofline of the building. He testified that the building was a two-story, frame cottage and was a two-flat. He testified that this was why the City's volumes of Sanborn Fire Insurance Maps showed the building as a two-and-a-half-story, as the building originally had two full stories with a half-story attic above. He testified that somewhere along the line, the building's third story was added. He testified that said third story was more than just dormers as it ran the full length of the building and established a full third floor. He testified that none of the City's records prior to 2010 show a three-story building. He testified that the 2010 Easy Permit was not to dormer the building. He testified that any attempt to dormer the building would have resulted in setback issues that the ZONING BOARD OF APPEALS would have had to address by way of a variation. He testified that based on the zoning district that has been in place since 1957, would have only allowed two dwelling units in 1957, and would have allowed only for approximately 2200 square feet of floor area, he believed the building had more floor area than allowed because of this third floor addition. He testified that even the architect agreed that the third floor addition had been added after 1957.

In response to questions by the ZONING BOARD OF APPEALS, Mr. Valenziano testified that he believed that the evidence showed that the building was a two-story cottage with two units (i.e., a two-flat). He testified he did not know how the third dwelling unit had been added to the building. He testified he did not know if the third dwelling unit met the City's Building Code because as far as he could see, the third dwelling unit did not go through a proper review and permitting process. He testified that he would say that the third dwelling unit had been added sometime after 1993, as the

⁶ In accordance with Section 17-13-1301 of the MCC ("Except as hereinafter provided, no permit pertaining to the use of land or buildings may be issued by any officer, department, or employee of this City unless the application for such permit has been examined by the Office of the Zoning Administrator and has affixed to it a certificate of the Office of the Zoning Administrator that the proposed building or structure complies with all the provisions of this Zoning Ordinance. Any permit or certificate of occupancy issued in conflict with the provisions of this Zoning Ordinance will be null and void").

1993 building permit stated that the building contained two dwelling units. He testified that he did not know when the third dwelling unit was added because there is no evidence. He testified that there is no building permit to add a third electrical meter. He testified that though the 2010 Easy Permit states there will be replacement of 3 water heaters, the addition of a third water heater would have required a building permit. He testified that the construction of a dormer required a building permit. He testified that the evidence showed that the building on the subject property contained two dwelling units in 1949 and in 1993. He testified that the 2010 Easy Permit should have been a building permit to construct an addition and to establish a third dwelling unit. He testified that such a permit would not have been allowed in a RS-3 zoning district.

In response to Mr. Valenziano's testimony, Mr. Manic was granted leave to recall Mr. Kaczmarek. Mr. Kaczmarek testified that because the kitchen and bathroom for the third dwelling unit are in the same stack as the floors below, this constituted evidence that the third dwelling unit was original to the building.

The ZONING BOARD OF APPEALS then asked Mr. Kaczmarek several questions with respect to stacking and other architectural and structural elements of the building.

Based on this line of questioning, Mr. Manic then called the ZONING BOARD OF APPEALS attention to the front ingress and back egress for each unit.

In response to questions by the ZONING BOARD OF APPEALS, Mr. Brenner testified that based on his examination of the framing and siding at the doorjamb, he believed the rear exit to the third floor dwelling unit was original. In contrast, Mr. Valenziano testified that he did not believe there had originally been a rear exit to the third floor.

Mr. Manic then stated that the 1993 building permit called the building a "two to three" story frame building.

The ZONING BOARD OF APPEALS stated that this did not mean there was a third floor dwelling unit. It stated that knowing whether a third floor rear exit existed in the 1950s, 1960s or 1970s would be helpful.

Mr. Manic stated that there were no eyewitnesses from those time periods. He stated that all they had to go on was Mr. Brenner's testimony that the door looked extremely old. He then reiterated the Appellant's argument: namely that the Appellant believed it had evidence that the building contained three legal nonconforming dwelling units. He then asked in the alternative that the ZONING BOARD OF APPEALS recognize the Appellant's right to have three dwelling units via administrative adjustment pursuant to Section 17-13-1003-BB of the MCC.⁷

⁷ The ZONING BOARD OF APPEALS has the power to grant a variation for any matter expressly authorized as an administrative adjustment. Section 17-13-1101-A of the MCC.

The ZONING BOARD OF APPEALS then asked the Appellant if the Appellant were paying taxes on the subject property as a two dwelling unit or a three dwelling unit building.

Mr. Manic stated that he did not know.

Mr. Brenner testified that he believed the Appellant paid property taxes on the subject property as a three dwelling unit building. He testified that Ms. Biazar was looking it up to verify.⁸

While Ms. Biazar was looking, Mr. Valenziano asked that if the ZONING BOARD OF APPEALS reversed the decision of the Zoning Administrator that the ZONING BOARD OF APPEALS require the Appellant to obtain an as-built building permit. He testified that this as-built building permit would make sure that the third dwelling unit met the City's Building Code and the City would therefore know that the third dwelling unit was a safe and lawful unit.

The ZONING BOARD OF APPEALS and Mr. Valenziano then had a discussion regarding this.

The ZONING BOARD OF APPEALS then stated it had received from its own staff the information it had requested from Ms. Biazar. It stated the Assessor's website showed that the subject property was being assessed as a two dwelling unit property.

Ms. Biazar testified that the Assessor's website described the property as being in the property class 211 category, which is for properties improved with two to six dwelling units. She testified that she did not see the number of legal dwelling units on the website.

In response to questions from the ZONING BOARD OF APPEALS, Mr. Valenziano testified that the back of every zoning certificate stated that it could be revoked due to error.

Mr. Manic agreed stating that a zoning certificate could be revoked due to incorrect information.

Mr. Valenziano testified that the information in this instance was determined to be incorrect. He testified that the Appellant's October 2018 application for certificate of zoning compliance stated that there were three dwelling units in the building. He testified that all evidence pointed to two dwelling units.

Mr. Manic said that the statement regarding three dwelling units was not incorrect information as there were, in fact, three dwelling units on the subject property.

Mr. Valenziano testified that the idea behind certificates of zoning compliance was to determine how many dwelling units were lawfully established in a building – not how

⁸ On the Cook County Assessor's website.

many dwelling units were in a building.⁹ He testified that he believed there were three dwelling units in the building.

In response from questions by the ZONING BOARD OF APPEALS, Ms. Biazar testified as to her conversations with the brokers that had represented the subject property in prior sales. She testified that because the 2009 sale of the subject property was a REO sale, the seller probably did not need to obtain a certificate of zoning compliance.

B. Criteria

Pursuant to Section 17-13-1201 of the MCC, the ZONING BOARD OF APPEALS is granted authority to hear and decide appeals when it is alleged there is an error in any order, requirement, decision or determination by the Zoning Administrator in the administration or enforcement of Chapter 17 of the MCC (the "Zoning Ordinance").

Pursuant to Section 17-13-1208 of the MCC, an appeal may only be sustained if the ZONING BOARD OF APPEALS finds that the Zoning Administrator erred. Pursuant to Section 17-13-1207 of the MCC, the Zoning Administrator's decision must be granted a presumption of correctness by THE ZONING BOARD OF APPEALS, placing the burden of persuasion of error on the Appellant.

III. FINDINGS OF FACT.

After careful consideration of the evidence, testimony and the entire record, the ZONING BOARD OF APPEALS hereby makes the following findings with respect to the Appellants' appeal:

1. The narrow issue on appeal is whether or not the Zoning Administrator erred with respect to the 2018 Zoning Certificate.
2. The ZONING BOARD OF APPEALS finds that the Zoning Administrator did not err with respect to the 2018 Zoning Certificate. The ZONING BOARD OF APPEALS agrees with the Zoning Administrator that the building on the subject property only contains two legal dwelling units. It is clear from the City's records and Mr. Valenziano's testimony that the third dwelling unit was established sometime after 1993 and therefore cannot qualify, as Mr. Manic argued, for legal non-conforming status. The ZONING BOARD OF APPEALS finds Mr. Valenziano to be a very credible witness. In contrast, the ZONING BOARD OF APPEALS does not find any of the Appellant's witnesses credible.
3. The ZONING BOARD OF APPEALS finds the Zoning Administrator is not equitably estopped from issuing the 2018 Zoning Certificate by either the 2012 Zoning Certificate or the 2010 Easy Permit. The 2010 Easy Permit was obtained without proper zoning review. Pursuant to Section 17-13-1301 of the MCC, it is therefore void, and the Appellant has no right to rely upon it. Similarly, as the

⁹ Section 3-33-045(C) of the MCC.

Zoning Administrator reserves the right to revoke a certificate of zoning compliance based on this "false or otherwise incorrect information provided by the applicant," the Appellant has no right to rely upon the 2012 Zoning Certificate. After all, the applicant for the 2012 Zoning Certificate did provide "false or otherwise incorrect information" when he stated that the building on the subject property contained three dwelling units. Therefore, the Zoning Administrator had the authority to revoke the 2012 Zoning Certificate.¹⁰ The ZONING BOARD OF APPEALS agrees with Mr. Valenziano that "dwelling units" in this instance refers to *legal* dwelling units. As a third legal dwelling unit would not be permitted on the subject property after 1957 and as the third dwelling unit was added sometime after 1993, there are not three legal dwelling units on the subject property. There are instead, only two legal dwelling units on the subject property. Since neither the 2010 Easy Permit nor the 2012 Zoning Certificate are valid permits, the doctrine of equitable estoppel is not applicable. *Foster & Kleiser, a Div. of Metromedia, Inc. v. City of Chicago*, 146 Ill.App.3d 928 (1st Dist. 1986). This is especially true when, as here, the hazard sought to be corrected affects the public safety and general welfare.

IV. CONCLUSION

For all of these reasons, the ZONING BOARD OF APPEALS finds that the Appellant has not met its burden of persuasion that the Zoning Administrator has erred as required by Section 17-13-1208 of the MCC.

The ZONING BOARD OF APPEALS hereby affirms the decision of the Zoning Administrator, and the Appellant's appeal is denied.

This is a final decision subject to review under the Illinois Administrative Review Law, 735 ILCS 5/3-101 *et seq.*

¹⁰ Which it did when it issued the 2018 Zoning Certificate.

ZONING BOARD OF APPEALS, CITY OF CHICAGO, CITY HALL, ROOM 905

APPLICANT: Lift Capital, LLC

CAL NO.: 127-19-Z

APPEARANCE FOR: Nicholas Ftikas

MINUTES OF MEETING:
February 15, 2019

APPEARANCE AGAINST: None

PREMISES AFFECTED: 4040 N. Hermitage Avenue

NATURE OF REQUEST: Application for a variation to reduce the rear setback from the required 49.5' to 25.38', south setback from 5' to zero to convert an existing three-story manufacturing building to a twelve dwelling unit building with a fourth story addition.

**ACTION OF BOARD-
VARIATION GRANTED**

THE VOTE

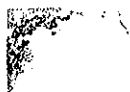
 MAR 18 2019
 CITY OF CHICAGO
 ZONING BOARD OF APPEALS

SHAINA DOAR
SOL FLORES
SAM TOIA
AMANDA WILLIAMS

AFFIRMATIVE	NEGATIVE	ABSENT
X		
X		
X		
X		

THE RESOLUTION:

WHEREAS, a public hearing was held on this application by the Zoning Board of Appeals at its regular meeting held on February 15, 2019 after due notice thereof as provided under Section 17-13-0107B and by publication in the Chicago Tribune on January 4, 2019; and

WHEREAS, the Zoning Board of Appeals, having reviewed the proposed finding of fact and having fully heard the testimony and arguments of the parties and being fully advised in the premises, hereby finds the following; the applicant shall be permitted to reduce the rear setback to 25.38', south setback to zero to convert an existing three-story manufacturing building to a twelve dwelling unit building with a fourth story addition; an additional variation was granted to the subject property in Cal. No. 128-19-Z; the Board finds 1) strict compliance with the regulations and standards of this Zoning Ordinance would create practical difficulties or particular hardships for the subject property; 2) the requested variation is consistent with the stated purpose and intent of this Zoning Ordinance; 3) the property in question cannot yield a reasonable return if permitted to be used only in accordance with the standards of this Zoning Ordinance; 4) the practical difficulties or particular hardships are due to unique circumstances and are not generally applicable to other similarly situated property; and 5) the variation, if granted will not alter the essential character of the neighborhood; it is therefore

RESOLVED, that the Zoning Board of Appeals, by virtue of the authority conferred upon it, does hereby make a variation in the application of the district regulations of the zoning ordinance and that the aforesaid variation request be and it hereby is granted subject to the following condition(s):

That all applicable ordinances of the City of Chicago shall be complied with before a permit is issued.

APPROVED AS TO SUBSTANCE



 CHAIRMAN

ZONING BOARD OF APPEALS, CITY OF CHICAGO, CITY HALL, ROOM 905

APPLICANT: Lift Capital, LLC

CAL NO.: 128-19-Z

APPEARANCE FOR: Nicholas Ftikas

MINUTES OF MEETING:
February 15, 2019

APPEARANCE AGAINST: None

PREMISES AFFECTED: 4040 N. Hermitage Avenue

NATURE OF REQUEST: Application for a variation to eliminate the one required off street loading zone to convert an existing manufacturing building to a twelve dwelling unit residential building.

**ACTION OF BOARD-
VARIATION GRANTED**

THE VOTE

MAR 18 2019
CITY OF CHICAGO
ZONING BOARD OF APPEALS

SHAINA DOAR
SOL FLORES
SAM TOIA
AMANDA WILLIAMS

AFFIRMATIVE	NEGATIVE	ABSENT
X		
X		
X		
X		

THE RESOLUTION:

WHEREAS, a public hearing was held on this application by the Zoning Board of Appeals at its regular meeting held on February 15, 2019 after due notice thereof as provided under Section 17-13-0107B and by publication in the Chicago Sun-Times on January 4, 2019; and

WHEREAS, the Zoning Board of Appeals, having reviewed the proposed finding of fact and having fully heard the testimony and arguments of the parties and being fully advised in the premises, hereby finds the following; the applicant shall be permitted to eliminate the one required off street loading zone to convert an existing manufacturing building to a twelve dwelling unit residential building; an additional variation was granted to the subject property in Cal. No. 127-19-Z; the Board finds 1) strict compliance with the regulations and standards of this Zoning Ordinance would create practical difficulties or particular hardships for the subject property; 2) the requested variation is consistent with the stated purpose and intent of this Zoning Ordinance; 3) the property in question cannot yield a reasonable return if permitted to be used only in accordance with the standards of this Zoning Ordinance; 4) the practical difficulties or particular hardships are due to unique circumstances and are not generally applicable to other similarly situated property; and 5) the variation, if granted will not alter the essential character of the neighborhood; it is therefore

RESOLVED, that the Zoning Board of Appeals, by virtue of the authority conferred upon it, does hereby make a variation in the application of the district regulations of the zoning ordinance and that the aforesaid variation request be and it hereby is granted subject to the following condition(s):

That all applicable ordinances of the City of Chicago shall be complied with before a permit is issued.

APPROVED AS TO SUBSTANCE

[Signature]

CHAIRMAN

ZONING BOARD OF APPEALS, CITY OF CHICAGO, CITY HALL, ROOM 905

APPLICANT: M & S Series, LLC, 831 Series **CAL NO.:** 129-19-S

APPEARANCE FOR: Nicholas Ftikas **MINUTES OF MEETING:**

February 15, 2019

APPEARANCE AGAINST: None

PREMISES AFFECTED: 831 S. Western Avenue

NATURE OF REQUEST: Application for a special use to expand an existing ground floor residential use for a proposed three-story rear addition, a rear third floor addition and a new one car garage connected to the front building and a rear building to be used as general retail sales and five dwelling units.

**ACTION OF BOARD-
APPLICATION APPROVED**

THE VOTE

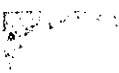

MAR 18 2019

CITY OF CHICAGO
ZONING BOARD OF APPEALS

SHAINA DOAR

SOL FLORES

SAM TOIA

AMANDA WILLIAMS

AFFIRMATIVE	NEGATIVE	ABSENT
X		
X		
X		
X		

THE RESOLUTION:

WHEREAS, a public hearing was held on this application by the Zoning Board of Appeals at its regular meeting held on February 15, 2019 after due notice thereof as provided under Section 17-13-0107B and by publication in the Chicago Sun-Times on January 4, 2019; and

WHEREAS, the Zoning Board of Appeals, having reviewed the proposed finding of fact and having fully heard the testimony and arguments of the parties and being fully advised in the premises, hereby finds the following; the applicant shall be permitted to expand an existing ground floor residential use for a proposed three-story rear addition, a rear third floor addition and a new one car garage connected to the front building and a rear building to be used as general retail sales and five dwelling units; a variation was also granted to the subject property in Cal. No. 130-19-Z; expert testimony was offered that the use would not have a negative impact on the surrounding community and is in character with the neighborhood; further expert testimony was offered that the use complies with all of the criteria as set forth by the code for the granting of a special use at the subject site; the Board finds the use complies with all applicable standards of this Zoning Ordinance; is in the interest of the public convenience and will not have a significant adverse impact on the general welfare of neighborhood or community; is compatible with the character of the surrounding area in terms of site planning and building scale and project design; is compatible with the character of the surrounding area in terms of operating characteristics, such as hours of operation, outdoor lighting, noise, and traffic generation; and is designed to promote pedestrian safety and comfort; it is therefore

RESOLVED, that the aforesaid special use request be and it hereby is approved and the Zoning Administrator is authorized to permit said special use subject to the following condition(s): provided the special use is issued solely to the applicant, M & S Series, LLC - 831 Series, and the development is consistent with the design and layout of the plans and drawings dated December 19, 2018, prepared by Rivetna Architects, Inc.

That all applicable ordinances of the City of Chicago shall be complied with before a permit is issued.

APPROVED AS TO SUBSTANCE

[Signature]

CHAIRMAN

ZONING BOARD OF APPEALS, CITY OF CHICAGO, CITY HALL, ROOM 905

APPLICANT: M & S Series LLC, 831 Series **CAL NO.:** 130-19-Z

APPEARANCE FOR: Nicholas Ftikas **MINUTES OF MEETING:**

APPEARANCE AGAINST: None February 15, 2019

PREMISES AFFECTED: 831 S. Western Avenue

NATURE OF REQUEST: Application for a variation to reduce the rear setback from the required 30' to zero on floors containing dwelling units for a proposed three-story rear addition, rear third floor addition and a one car garage connecting the front building to the rear building to be used as general retail sales and five dwelling units.

**ACTION OF BOARD-
VARIATION GRANTED**

THE VOTE

MAR 18 2019
CITY OF CHICAGO
ZONING BOARD OF APPEALS

SHAINA DOAR
SOL FLORES
SAM TOIA
AMANDA WILLIAMS

AFFIRMATIVE	NEGATIVE	ABSENT
X		
X		
X		
X		

THE RESOLUTION:

WHEREAS, a public hearing was held on this application by the Zoning Board of Appeals at its regular meeting held on February 15, 2019 after due notice thereof as provided under Section 17-13-0107B and by publication in the Chicago Tribune on January 4, 2019; and

WHEREAS, the Zoning Board of Appeals, having reviewed the proposed finding of fact and having fully heard the testimony and arguments of the parties and being fully advised in the premises, hereby finds the following; the applicant shall be permitted to reduce the rear setback to zero on floors containing dwelling units for a proposed three-story rear addition, rear third floor addition and a one car garage connecting the front building to the rear building to be used as general retail sales and five dwelling units; a special use was also granted to the subject property in Cal. No. 129-19-S; the Board finds 1) strict compliance with the regulations and standards of this Zoning Ordinance would create practical difficulties or particular hardships for the subject property; 2) the requested variation is consistent with the stated purpose and intent of this Zoning Ordinance; 3) the property in question cannot yield a reasonable return if permitted to be used only in accordance with the standards of this Zoning Ordinance; 4) the practical difficulties or particular hardships are due to unique circumstances and are not generally applicable to other similarly situated property; and 5) the variation, if granted will not alter the essential character of the neighborhood; it is therefore

RESOLVED, that the Zoning Board of Appeals, by virtue of the authority conferred upon it, does hereby make a variation in the application of the district regulations of the zoning ordinance and that the aforesaid variation request be and it hereby is granted subject to the following condition(s):

That all applicable ordinances of the City of Chicago shall be complied with before a permit is issued.

APPROVED AS TO SUBSTANCE

[Signature]

CHAIRMAN

ZONING BOARD OF APPEALS, CITY OF CHICAGO, CITY HALL, ROOM 905

APPLICANT: Marco Antonio Santay dba Marco's Barber Shop, Inc.

CAL NO.: 131-19-S

APPEARANCE FOR: Same as Applicant

MINUTES OF MEETING:
February 15, 2019

APPEARANCE AGAINST: None

PREMISES AFFECTED: 4008 W. 63rd Street

NATURE OF REQUEST: Application for a special use to establish a barber shop.

**ACTION OF BOARD-
APPLICATION APPROVED**

THE VOTE

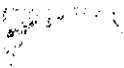

MAR 18 2019

CITY OF CHICAGO
ZONING BOARD OF APPEALS

SHAINA DOAR
SOL FLORES
SAM TOIA
AMANDA WILLIAMS

AFFIRMATIVE	NEGATIVE	ABSENT
X		
X		
X		
X		

THE RESOLUTION:

WHEREAS, a public hearing was held on this application by the Zoning Board of Appeals at its regular meeting held on February 15, 2019 after due notice thereof as provided under Section 17-13-0107B and by publication in the Chicago Sun-Times on January 4, 2019; and

WHEREAS, the Zoning Board of Appeals, having reviewed the proposed finding of fact and having fully heard the testimony and arguments of the parties and being fully advised in the premises, hereby finds the following; the applicant shall be permitted to establish a barber shop; expert testimony was offered that the use would not have a negative impact on the surrounding community and is in character with the neighborhood; further expert testimony was offered that the use complies with all of the criteria as set forth by the code for the granting of a special use at the subject site; the Board finds the use complies with all applicable standards of this Zoning Ordinance; is in the interest of the public convenience and will not have a significant adverse impact on the general welfare of neighborhood or community; is compatible with the character of the surrounding area in terms of site planning and building scale and project design; is compatible with the character of the surrounding area in terms of operating characteristics, such as hours of operation, outdoor lighting, noise, and traffic generation; and is designed to promote pedestrian safety and comfort; it is therefore

RESOLVED, that the aforesaid special use request be and it hereby is approved and the Zoning Administrator is authorized to permit said special use subject to the following condition(s): provided the special use is issued solely to the applicant, Marco Antonio Santay.

That all applicable ordinances of the City of Chicago shall be complied with before a permit is issued.

APPROVED AS TO SUBSTANCE

[Signature]

act. CHAIRMAN

**ZONING BOARD OF APPEALS
CITY OF CHICAGO**

City Hall Room 905
121 North LaSalle Street
Chicago, Illinois 60602
TEL: (312) 744-3888



MAR 18 2019

CITY OF CHICAGO
ZONING BOARD OF APPEALS

Wrigley Field Parking Operations, LLC

APPLICANT

**132-19-S, 133-19-Z,
134-19-Z & 135-19-Z**
CALENDAR NUMBERS

1102 W. Waveland Avenue

PREMISES AFFECTED

February 15, 2019

HEARING DATE

ACTION OF BOARD

THE VOTE

The application for the special use is approved subject to the conditions specified below. The applications for the variations are approved.

Shaina Doar
Sol Flores
Sam Toia
Amanda Williams

AFFIRMATIVE	NEGATIVE	ABSENT
<input checked="" type="checkbox"/>	<input type="checkbox"/>	<input type="checkbox"/>
<input checked="" type="checkbox"/>	<input type="checkbox"/>	<input type="checkbox"/>
<input checked="" type="checkbox"/>	<input type="checkbox"/>	<input type="checkbox"/>
<input checked="" type="checkbox"/>	<input type="checkbox"/>	<input type="checkbox"/>

**FINDINGS OF THE ZONING BOARD OF APPEALS
IN THE MATTER OF THE SPECIAL USE AND VARIATION APPLICATIONS
FOR 1102 W. WAVELAND AVENUE BY WRIGLEY FIELD PARKING
OPERATIONS, LLC**

I. BACKGROUND

Wrigley Field Parking Operations, LLC (the "Applicant") submitted a special use application and variation applications for 1102 W. Waveland (the "subject property"). The subject property is currently zoned RT-4 and is improved with a surface parking lot. The Applicant proposed to improve the surface parking lot. To permit this improvement, the Applicant sought a special use to establish a non-accessory parking lot. The Applicant also sought variations to: (1) reduce the rear setback from the required 50' to 0'; (2) reduce the rear yard open space from the required 2,647.1 square feet to 0; and (3) reduce the landscape setback from 7' to 5' on Seminary Avenue, eliminate the landscape setback on W. Waveland and W. Grace, eliminate 28 trees and 223 shrubs for screening on Seminary, Waveland and Grace, reduce the interior landscape area from 3,610 square feet to 0, eliminate 29 interior trees, increase the ornamental fence height from 6' to 8' on Waveland and replace 678.9' of solid screen or hedge with 8' high chain link fence along the alley. In accordance with Section 17-13-0903 of the Chicago Zoning Ordinance, the Zoning Administrator of the City's Department of Planning and Development ("Zoning Administrator") recommended approval of the non-accessory parking lot provided that: (1) the special use was issued solely to the Applicant; the special use ceased on the third (3rd) anniversary of the date of its approval; and development was consistent with the

APPROVED AS TO SUBSTANCE

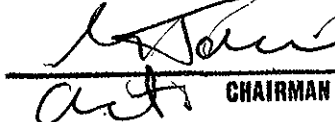
CHAIRMAN

plans and drawings attached to its recommendation (“Improvements”) stamped final and dated February 15, 2019, which Improvements were to be the sole responsibility of the Applicant and constructed at the Applicant’s sole cost and expense.

II. PUBLIC HEARING

A. The Hearing

The ZONING BOARD OF APPEALS held a public hearing on the Applicant’s special use and variation applications at its regular meeting held on February 15, 2019, after due notice thereof as provided under Section 17-13-0107-B of the Chicago Zoning Ordinance and by publication in the *Chicago Sun-Times*. In accordance with the ZONING BOARD OF APPEALS’ Rules of Procedure, the Applicant had submitted its proposed Findings of Fact. The Applicant’s vice presidents Mr. Carl Rice and Mr. Michael Lufrano as well as its attorney Ms. Liz Butler were present. Also present on behalf of the Applicant was its land planner Mr. George Kisiel. Assistant Zoning Commissioner Steven Valenziano testified on behalf of the City’s Department of Planning and Development (“Department”). Testifying in support of the applications were 44th ward alderman Alderman Tom Tunny (the “Alderman”), Mr. Jim Spencer, Ms. Maureen O’Donnell, and Mr. John Fitterer. Testifying in opposition to the applications were Mr. Kevin Mars, Ms. Pamela Hazard, and Ms. Bridget Iwamuro (collectively, the “Objectors”). Also testifying with the respect to the applications were Mr. Tom English and Ms. Christine Welch. The statements and testimony given during the public hearing were given in accordance with the ZONING BOARD OF APPEALS’ Rules of Procedure.

The Applicant’s attorney Ms. Liz Butler explained to the ZONING BOARD OF APPEALS that the subject property was currently improved with an existing surface parking lot. She stated that such existing surface parking lot had operated as a non-required off-site accessory parking lot and had served Wrigley Field for the past fifty-years. She then submitted and the ZONING BOARD OF APPEALS accepted into the record a photograph of the subject property taken from the southwest on or about December 29, 1963.

She stated that for the past three years, the subject property has contained a tent structure that has been used during Wrigley Field events. She stated that the tent was established pursuant to a permit issued by the City. She stated that the City decided not to reissue the permit for the tent after neighbors expressed concern about the appearance of the tent and its potential for noise on rainy days. She stated that after the Applicant was informed by the City that the City would not reissue the permit, the Applicant had worked with City staff and the Alderman and had met with community members multiple times, most recently February 5, 2019 and February 12, 2019. She stated that as a result of such meetings, the Applicant had agreed to construct the Improvements on the subject property.

She stated that the Applicant is therefore seeking approval of a special use in order to clarify its ability to operate and upgrade the existing surface parking lot. She stated that

the Applicant is also seeking variations. She stated that the applications before the ZONING BOARD OF APPEALS reflect a compromise agreement between the Applicant, the City and the community to allow time for the parties to resolve certain disputes regarding ownership and permitted uses of the subject property. She stated that as a result, the City and the Applicant have agreed and acknowledged that the applications are a highly negotiated compromise and that neither party is intending to waive or relinquish any ownership or other right or interest that either party has in the subject property or change either party's position or rights with respect to the allowed use or improvement of the subject property or assume or admit any liability or fact with respect to the subject property.¹

She stated that in addition to the principal use of the subject property as a non-accessory parking lot, the subject property would also have an accessory use that included a family staging and hospitality area where Cubs players' families would be hosted during Wrigley Field events. She stated that such accessory use was reflected on the Applicant's site plan. She stated that the proposed special use is consistent with the current and long-term existing parking use of the subject property. She stated that the Improvements do not represent a change in the historic use of the subject property but instead are intended to facilitate site improvements to match the needs of the Applicant and the subject property's immediate neighbors.

The Applicant presented the testimony of its vice president Mr. Carl Rice III. Mr. Rice testified that he served as a project manager for the Improvements to the subject property and therefore has specific knowledge regarding the Improvements to and operations of the subject property. He testified that if he were to continue to testify his testimony would be consistent with his affidavit contained in the Applicant's proposed Findings of Fact. He testified that the subject property is currently improved with an existing paved parking lot which offers parking for Cubs players. He testified that in place of the tent structure currently on the subject property, the Applicant planned to install a high-quality canopy structure at the southern portion of the subject property to provide security and protection from the elements for the proposed vehicle traffic. He testified as to the canopy's dimensions and its exterior finishes. He testified that the subject property is currently and will continue to be secured by fencing to prevent unauthorized access to the parking lot.

He testified that in order to enhance security, the aesthetic appearance of the parking lot and privacy for neighbors to the east and west of the subject property, the Applicant proposes to erect a 6' high decorative metal fence along the subject property's eastern (Seminary) frontage and a 8' high chain-link fence along the subject property's western (alley) frontage. He testified that this fencing would include privacy screening elements. He testified that in order to address concerns from the neighbors to the west of the subject property, the Applicant moved the proposed fence line on the subject property's western frontage approximately 2' to the east and shifted the northern fence to the south. He testified that the Applicant planned to reestablish the curb along the eastern frontage of

¹ For particulars, please see that certain standstill agreement by and between City and the Applicant, dated as of February 15, 2019, and received by the ZONING BOARD OF APPEALS prior to the hearing.

the subject property where the Applicant will include an enhanced 5' wide landscape setback.

He testified that vehicles will enter and exit the subject property via the West Grace Street or West Waveland Avenue gates. He testified that pedestrians may enter and exit the subject property via a man-gate on West Waveland or via the other entrances. He testified that the Applicant will continue to work with its own security team and the City's Police Department to address any concerns that may result from these changes. He testified that the Applicant's landscape plan reflects the approximately forty (40) shade trees that will be planted at the subject property as part of the Applicant's special use approval. He testified that there are existing trees on the subject property that the Applicant would maintain. He testified that the new trees would have 4" caliper. He testified that he had worked with the Applicant's landscape architects to determine the right tree height for the new trees based on the lighting requirements for the parking lot and the electrical lines inside the parking lot. He testified that a greater tree size would interrupt and hit the electrical lines as well as block some of the lighting in the parking lot that currently exists. He testified that therefore the caliper size was chosen to be appropriate for the height of the electrical lines and the lighting.

In response to questions from Mr. Kevin Mars, of 3743 N. Seminary Avenue, Mr. Rice testified that the trees will continue to grow but that because the Applicant chose a type and species of tree that is limited to 24' to 26' in height, the new trees will not hit the electrical lines. He testified that he had brought with him material samples of the proposed fences.

The Applicant presented the testimony of its land planner Mr. George Kisiel. The ZONING BOARD OF APPEALS recognized Mr. Kisiel's credentials as an expert in land planning. Mr. Kisiel testified that he had been retained by the Applicant to conduct an urban planning analysis of the proposed special use and variations. He testified that he had prepared a report detailing his analysis, findings and conclusion and that said report had been previously submitted to the ZONING BOARD OF APPEALS as part of the Applicant's proposed Finding of Fact. He then testified as to the conclusions of his report, namely that the proposed special use and variations met all applicable standards for special uses and variations as set forth in the Chicago Zoning Ordinance.

In response to further questions from Mr. Mars, Mr. Rice testified that the Applicant had not brought samples of the east side fence. He testified that the plans regarding said fence had been attached to the Department's recommendation to the ZONING BOARD OF APPEALS. He testified that it was a metal fence and that the same screening would be used on both the east and west sides of the fence.

Assistant Zoning Administrator Steven Valenziano testified that the Improvements attached to the Department's recommendation to the ZONING BOARD OF APPEALS included a wrought iron metal fence along the property lines of the subject property that fronted streets as required by the Chicago Zoning Ordinance. He testified that the Applicant would be installing a chain-link fence along the alley frontage of the subject

property. He testified that the fencing would have mesh to screen it when the Cubs were using the parking lot. He testified that during the off-season, the Applicant would take down the mesh, and the fences would be clear and open like any other parking lot.

In response to further questions from Mr. Mars and Ms. Pamela Hazard, of 3751 N. Seminary, Mr. Rice further testified that the mesh will be affixed to the fence from the inside of the fence and will be green, without any words or advertising.

Ms. Hazard testified in opposition to the applications. She testified that while she was glad to see some of the Applicant's upgrades to the subject property, she was concerned about the trees. She testified as to her past experiences with the Cubs and trees and requested that the Applicant provide larger trees than 4" caliper. She then requested that the Applicant provide landscaping on Grace as well as preserve the tree that still existed on the subject property alongside Grace. She testified that the trailers on the subject property were unacceptable and an eye sore. She testified that the privacy screening on the fence looked similar to construction screening and construction screening looked horrible after a short period of time. She requested that the Applicant provide more aesthetically pleasing privacy screening.

Mr. Mars testified in opposition to the applications. He testified that Ms. Hazard had hit almost all points he had been going to address. He testified that when he had moved in to his home, he had known he would be moving across the street from a parking lot but he had not expected to live across the street from a construction staging area. He testified that construction trailers had been on the subject property for the last four years. He testified that he would like to give some suggestions for the alternative use of the subject property.

The ZONING BOARD OF APPEALS stated it was a zoning board of appeals and was therefore limited with respect to what it could and could not do.

Ms. Bridget Iwamuro, of 3745 N. Seminary, testified in opposition to the applications. Her opposition stemmed from her anger at the trees the Applicant had previously removed from the subject property. She presented to and the ZONING BOARD OF APPEALS accepted into the record a series of photographs showing the trees and tree stumps that remained on the subject property. She testified that she wanted the ZONING BOARD OF APPEALS to hold the Applicant to a higher standard when considering its applications.

Ms. Hazard further testified that as the Applicant wished the proposed canopy to be installed by Opening Day, she wished all the proposed landscaping for the subject property also be installed by Opening Day.

In response to Ms. Hazard's wishes, Mr. Rice testified that the Applicant intended to install as much of the proposed landscaping for Opening Day. He testified that there was a question as to whether or not the Applicant could procure every type of tree that is on the landscaping plan in time and have them planted for the start of the baseball season.

He testified that there were 51 days until Opening Date and that while the Applicant intended to try and get as much done as possible by that time, he was aware of one type of tree that would not be delivered until after that date. He testified that if the weather cooperated, he anticipated that the landscaping would all be completed by May 1, 2019. He testified that if the weather did not cooperate, June 1, 2019 would be a "really safe date."

In response to questions by the ZONING BOARD OF APPEALS regarding the landscaping, especially the size of the new trees, Mr. Rice testified that with respect to the choice of size of the new trees, the issue really was a question of width versus height and depth. He testified that the issue for the Applicant was finding the right tree that met all those requirements but did not infringe on the street lighting or the lighting in the parking lot.

In response to further questions by the ZONING BOARD OF APPEALS regarding the landscaping, especially the size of the new trees, Assistant Zoning Administrator Steven Valenziano testified that the Department reviews all landscaping. He testified that the Department had a licensed landscape architect on staff that had reviewed the Applicant's proposed landscaping. He testified that the Department's landscape architect had reviewed the tree species the Applicant had chosen. He testified that a 4" caliper tree is larger than what the City would require (with the exception of the downtown area). He testified that in his experience in working with the Landscape Ordinance² that the larger the caliper of the tree, the slower it takes the tree to establish itself. He testified that the Applicant's tree species were picked out so that they would not interfere with the overhead electrical lines and the lighting that is already in place because the subject property is not a normal situation where one has a parkway, a sidewalk and then a parking lot. He testified that there is basically a curb and a 5' area of dirt and that's all the room there is for the trees, both the existing trees and the future trees. He testified that the Chicago Zoning Ordinance requires 1 tree per 25' of frontage along a street.³ He testified that the Applicant is putting in 1 tree for every 15'. He testified that the Department has looked at the Applicant's landscape plans. He testified that the Chicago Zoning Ordinance requires that the Applicant look at its existing trees on the subject property and provide the Department with an assessment of the health of each tree, the species of each tree and the age or diameter of the tree. He testified that the Applicant would be required to provide this to the Department at the time the Applicant went in to obtain permits. He testified that therefore the trees would be looked at by the Department at the time the Applicant went in for permits.

In response to the Objectors' testimony, Mr. Rice further testified that the subject property's frontage along Grace Street currently has grass, an existing tree and a driveway. He testified that after the Improvements, the subject property's frontage along Grace Street would be similar to what is there now. He then walked the ZONING BOARD OF APPEALS through the Applicant's landscape plan.

² Chapter 17-11 of the Chicago Zoning Ordinance.

³ Section 17-11-0103-A(1) of the Chicago Zoning Ordinance.

Mr. Tom English, of 3759 N. Clifton, testified that he was "on the fence" about the applications because although he believed the Applicant had made accommodations with respect to the Improvements that he appreciated, he believed the Applicant's hardship was self-imposed.

Mr. Jim Spencer, of 3646 N. Wilton, testified in support of the applications.

Ms. Maureen O'Donnell, of 3646 N. Wilton, testified in support of the applications.

Ms. Christine Welch, of 3734 N. Kenmore Avenue, testified that while she supported the Applicant's continued use of the subject property as a parking lot, she also requested that the Applicant install larger, more mature trees on the subject property.

Mr. John Fitterer, of 3714 N. Fremont, testified in support of the applications.

The Alderman testified as to the history of the subject property as well as the history of the dispute between the City, the Applicant and the community with respect to the subject property. He testified that the Improvements were the result of many compromises and a lot of input from many City departments as well as the neighborhood. He testified that, after a year of research by a title company, the alley adjacent to the subject property had turned out to be only 10' rather than 12' wide. He testified that although the Applicant was providing the additional 2' for the alley, this 2' impacted the Applicant's ability to sufficiently align its parking on the subject property. He testified that there is still much work to be done with respect to the subject property in the long-term but that the Applicant's applications represent an interim solution that is much nicer than a current condition of the subject property. He testified that he believed the proposed applications were a good compromise and that he hoped that the ZONING BOARD OF APPEALS would approve said applications.

In response to questions by the ZONING BOARD OF APPEALS, Mr. Rice further testified in more detail as to the screening that would be attached to the proposed fencing. He then testified that the trailers on the subject property are not construction trailers but rather hospitality trailers for Cubs players' families. He testified that providing such a space for players' families is common in the baseball industry and due to security concerns after games, it is necessary to provide a place for all of the players' families to be together.

In response to further testimony from Ms. Hazard, the ZONING BOARD OF APPEALS stated it was not here to consider alternative plans or uses for the subject property but rather the plans and uses that were currently before the ZONING BOARD OF APPEALS.

The ZONING BOARD OF APPEALS then asked the Applicant if it would be possible to make the trailers more aesthetically pleasing.

Mr. Rice testified that the Applicant would look into ways to make the trailers more aesthetically pleasing.

B. Criteria for a Special Use

Pursuant to Section 17-13-0905-A of the Chicago Zoning Ordinance, no special use application may be approved unless the ZONING BOARD OF APPEALS finds that the proposed use in its proposed location meets all of the following criteria: (1) it complies with all applicable standards of the Chicago Zoning Ordinance; (2) it is in the interest of the public convenience and will not have a significant adverse impact on the general welfare of the neighborhood or community; (3) it is compatible with the character of the surrounding area in terms of site planning and building scale and project design; (4) it is compatible with the character of the surrounding area in terms of operating characteristics, such as hours of operation, outdoor lighting, noise and traffic generation; and (5) it is designed to promote pedestrian safety and comfort.

C. Criteria for a Variation

Pursuant to Section 17-13-1107-A of the Chicago Zoning Ordinance, no variation application may be approved unless the ZONING BOARD OF APPEALS finds, based upon the evidence presented to it in each specific case, that: (1) strict compliance with the standards of the Chicago Zoning Ordinance would create practical difficulties or particular hardships; and (2) the requested variation is consistent with the stated purpose and intent of the Chicago Zoning Ordinance.

Pursuant to Section 17-13-1107-B of the Chicago Zoning Ordinance, in order to determine that practical difficulties or particular hardships exist, the ZONING BOARD OF APPEALS must find evidence of each of the following: (1) the property in question cannot yield a reasonable return if permitted to be used only in accordance with the standards of the Chicago Zoning Ordinance; (2) the practical difficulties or particular hardships are due to unique circumstances and are not generally applicable to other similarly situated property; and (3) the variation, if granted, will not alter the essential character of the neighborhood.

Pursuant to Section 17-13-1107-C of the Chicago Zoning Ordinance, in making its determination of whether practical difficulties or particular hardships exist, the ZONING BOARD OF APPEALS must take into consideration the extent to which evidence has been submitted substantiating the following facts: (1) the particular physical surroundings, shape or topographical condition of the specific property involved would result in a particular hardship upon the property owner as distinguished from a mere inconvenience, if the strict letter of the regulations were carried out; (2) the conditions upon which the petition for a variation is based would not be applicable, generally, to other property within the same zoning classification; (3) the purpose of the variation is not based exclusively upon a desire to make more money out of the property; (4) the alleged practical difficulty or particular hardship has not been created by any person presently having an interest in the property; (5) the granting of the variation will not be

detrimental to the public welfare or injurious to other property or improvements in the neighborhood in which the property is located; and (6) the proposed variation will not impair an adequate supply of light and air to adjacent property, or substantially increase the congestion in the public streets, or increase the danger of fire, or endanger the public safety, or substantially diminish or impair property values within the neighborhood.

III. FINDINGS OF FACT

After careful consideration of the evidence, testimony and the entire record, including the Applicant's proposed Findings of Fact, the ZONING BOARD OF APPEALS hereby makes the following findings with reference to the Applicant's application for a special use pursuant to Section 17-13-0905-A of the Chicago Zoning Ordinance:

1. *The proposed special use complies with all applicable standards of the Chicago Zoning Ordinance.*

The subject property is located in a RT-4 zoning district. The Applicant's proposed non-accessory parking lot is a special use in a RT zoning district.⁴ As Mr. Kisiel credibly testified and as set forth in far greater detail in his report, should the special use and variations be granted, the proposed special use will comply with all applicable standards of the Chicago Zoning Ordinance. Since the ZONING BOARD OF APPEALS has decided to grant the special use and variations to the Applicant, the Applicant's proposed special use complies with all applicable standards of the Chicago Zoning Ordinance.

2. *The proposed special use is in the interest of the public convenience and will not have a significant adverse impact on the general welfare of the neighborhood or community.*

The proposed special use is in the interest of the public convenience in that it will allow for the continued use of the subject property with enhanced facilities. These enhanced facilities, including the new trees, fences and privacy screening will have a positive impact on surrounding development and the public ways. In particular, the Applicant's proposed canopy will be a vast improvement over the current tent.

3. *The proposed special use is compatible with the character of the surrounding area in terms of site planning and building scale and project design.*

The subject property has been operated as a parking lot for the past fifty years. The proposed special use will enhance the streetscape and improve the pedestrian experience in the area, especially as the Applicant will be re-establishing the curbcut along the east (Seminary) frontage of the subject property as well as providing trees for every 15' of street frontage.

⁴ Section 17-9-0111.5 of the Chicago Zoning Ordinance.

4. *The proposed special use is compatible with the character of the surrounding area in terms of operating characteristics, such as hours of operation, outdoor lighting, noise and traffic generation.*

The subject property has operated a parking lot for the past fifty years. Its hours of operation, traffic generation and noise generation will be consistent with the active mixed-use character of the surrounding neighborhood.

5. *The proposed special use is designed to promote pedestrian safety and comfort.*

The proposed special use will allow the Applicant to provide enhanced streetscaping, such as the landscaping and fences along Seminary. This will make the pedestrian experience on Seminary much more comfortable, especially as the landscaping and fencing will replace the unattractive construction fence currently surrounding the subject property. Further, the vehicular access point on Grace Street is set back to adequately provide safety and visibility for pedestrians.

After careful consideration of the evidence, testimony and the entire record, including the Applicant's proposed Findings of Fact, the ZONING BOARD OF APPEALS hereby makes the following findings with reference to the Applicant's applications for variations pursuant to Section 17-13-1107-A of the Chicago Zoning Ordinance:

1. *Strict compliance with the regulations and standards of the Chicago Zoning Ordinance would create practical difficulties or particular hardships for the subject property.*

Due to the subject property's irregular size and shape, the fact it is fronted on all four sides by a public way (including the incredibly narrow 10' alley to its west and the substandard 20' wide Seminary to its east), and security concerns caused by its use as a parking lot for Cubs players, strict compliance with the regulations and standards of the Chicago Zoning Ordinance would create practical difficulties or particular hardships for the subject property in that the Applicant could not provide the Improvements to the subject property without the requested variations.

2. *The requested variations are consistent with the stated purpose and intent of the Chicago Zoning Ordinance.*

Pursuant to Section 17-1-0501 of the Chicago Zoning Ordinance, the requested variations promote the public health, safety and general welfare. Pursuant to Section 17-1-0502 of the Chicago Zoning Ordinance, the requested variations will preserve the overall quality of life for residents and visitors. Pursuant to Section 17-1-508 of the Chicago Zoning Ordinance, the requested variations will maintain orderly and compatible land use and development practices. Pursuant to Section 17-1-0514 of the Chicago Zoning Ordinances, the requested variations

accommodate growth and development that comply with the other stated purposes the Chicago Zoning Ordinance.

After careful consideration of the evidence, testimony and the entire record, including the Applicant's proposed Findings of Fact, the ZONING BOARD OF APPEALS hereby makes the following findings with reference to the Applicant's applications for variations pursuant to Section 17-13-1107-B of the Chicago Zoning Ordinance:

1. *The property in question cannot yield a reasonable return if permitted to be used only in accordance with the standards of the Chicago Zoning Ordinance.*

As the Applicant will continue to own and operate the subject property, reasonable rate of return is, in this instance, the ability of the Applicant to provide much needed upgrades to the subject property without losing its ability to operate the subject property as a parking lot. As very credibly testified to by Mr. Kisiel and as set forth in far greater detail in his report, without the requested variations, the Applicant would lose approximately one-third of its parking spaces and therefore would no longer be able to reasonably and efficiently use the subject property.

2. *The practical difficulties or particular hardships are due to unique circumstances and are not generally applicable to other similarly situated property.*

As noted above, the particular difficulties or particular hardships are due to the subject property's irregular size and shape, the fact it is fronted on all four sides by a public way (including the incredibly narrow 10' alley to its west and the substandard 20' wide Seminary to its east), and security concerns caused by its use as a parking lot for Cubs players. These are unique circumstances that are not generally applicable to other residential property.

3. *The variations, if granted, will not alter the essential character of the neighborhood.*

The variations will allow the Applicant to provide upgrades to the parking lot on the subject property. As the subject property has been used as a parking lot for Wrigley Field since the 1960s, the variations will not alter the essential character of the neighborhood. In fact, the variations will instead allow the parking lot to better complement the nearby residential use.

After careful consideration of the evidence, testimony and the entire record, including the Applicant's proposed Findings of Fact, the ZONING BOARD OF APPEALS hereby makes the following findings with reference to the Applicant's applications for variations pursuant to Section 17-13-1107-C of the Chicago Zoning Ordinance:

1. *The particular physical surroundings, shape or topographical condition of the specific property involved would result in a particular hardship upon the property*

owner as distinguished from a mere inconvenience, if the strict letter of the regulations were carried out.

The particular physical surroundings – that is, the fact it is fronted on all four sides by a public way (including the incredibly narrow 10' alley to its west and the substandard 20' wide Seminary to its east) – as well as the irregular size and shape of the subject property would result in particular hardship upon the Applicant. As very credibly testified to by Mr. Kisiel and as set forth in far greater detail in his report, without the requested variations, the Applicant would lose approximately one-third of its parking spaces.

- 2. The conditions upon which the petition for the variations is based would not be applicable, generally, to other property within the same zoning classification.*

The subject property's irregular size and shape as well, the fact it is fronted on all four sides by a public way (including the incredibly narrow 10' alley to its west and the substandard 20' wide Seminary to its east), and security concerns caused by its use as a parking lot for Cubs players are conditions not applicable, generally, to other property within the RT-4 zoning classification.

- 3. The purpose of the variations is not based exclusively upon a desire to make more money out of the property.*

The variations will allow the Applicant to reasonably and efficiently use the subject property as a parking lot for Cubs players and their families. The Applicant is not maximizing parking on the subject property in order to provide parking spaces for hire. Further, the variations themselves were the result of a compromise between the City, the Applicant and community members. In sum, the purpose of the variations is not based exclusively upon a desire to make more money out of the subject property.

- 4. The alleged practical difficulty or particular hardship has not been created by any person presently having an interest in the property.*

The Applicant did not create the subject property's irregular size and shape. The Applicant also did not create the fact that the subject property is fronted on all four sides by a public right of way (including the incredibly narrow 10' alley to its west and the substandard 20' wide Seminary to its east). The Applicant also did not create the need for security.

- 5. The granting of the variations will not be detrimental to the public welfare or injurious to other property or improvements in the neighborhood in which the property is located.*

The variations will substantially improve the public welfare and will not be injurious to other property or improvements in the neighborhood. The variations will allow the Applicant to maintain reasonable and efficient use of its long time parking lot while at the same time provide the Improvements, which Improvements will be enhancements to not only the subject property but the entire neighborhood. There will be attractive streetscaping and landscaping, including 4" caliper trees for every 15' of street frontage.

6. *The variations will not impair an adequate supply of light and air to adjacent property, or substantially increase the congestion in the public streets, or increase the danger of fire, or endanger the public safety, or substantially diminish or impair property values within the neighborhood.*

As shown by the Improvements, the variations will not impair an adequate supply of light and air to adjacent property. The variations will not substantially increase congestion in the public streets because they will allow the Applicant to not lose one-third of its parking. There is nothing with respect to the Improvements that would increase the danger of fire. The variations will enhance rather than endanger the public safety and therefore not diminish or impair property values within the neighborhood.

IV. CONCLUSION

For all of these reasons, the ZONING BOARD OF APPEALS finds that the Applicant has proved its case by evidence, testimony and the entire record, including the Applicant's proposed Findings of Fact, covering: (1) the specific criteria for a special use pursuant to Section 17-13-0905-A of the Chicago Zoning Ordinance; and (2) the specific criteria for a variation pursuant to Sections 17-13-1107-A, B and C of the Chicago Zoning Ordinance.

The ZONING BOARD OF APPEALS hereby approves the Applicant's application for a special use, and pursuant to the authority granted to the ZONING BOARD OF APPEALS by Section 17-13-906 of the Chicago Zoning Ordinance, the Zoning Administrator is authorized to permit said special use subject to the following conditions:

1. The special use shall be issued solely to the Applicant;
2. The special use shall cease on the third (3rd) anniversary of the date of its approval; and
3. Development shall be consistent with the attached plans and drawings ("Improvements") stamped final and dated February 15, 2019, which Improvements shall be the sole responsibility of the Applicant and constructed at the Applicant's sole cost and expense.

The ZONING BOARD OF APPEALS hereby approves the Applicant's applications for variations, and the Zoning Administrator is authorized to permit said variations.

This is a final decision subject to review under the Illinois Administrative Review Law, 735 ILCS 5/3-101 *et seq.*

poligon[®]

FINAL for ZBA
February 15, 2019

PROJECT: BLUE LOT SHELTER
 LOCATION: CHICAGO, IL
 BUILDING TYPE: NSL-53X133
 ROOF TYPE: ASPHALT SHINGLES OVER T & G
 BUILDING NUMBER: 18929
 ORDER NUMBER: 63949

DRAWING LIST:

SHEET NUMBER	DRAWING DESCRIPTION
CS	COVER SHEET
1	ARCHITECTURAL ELEVATIONS
2	STRUCTURAL FRAMING PLAN
3	COLUMN LAYOUT

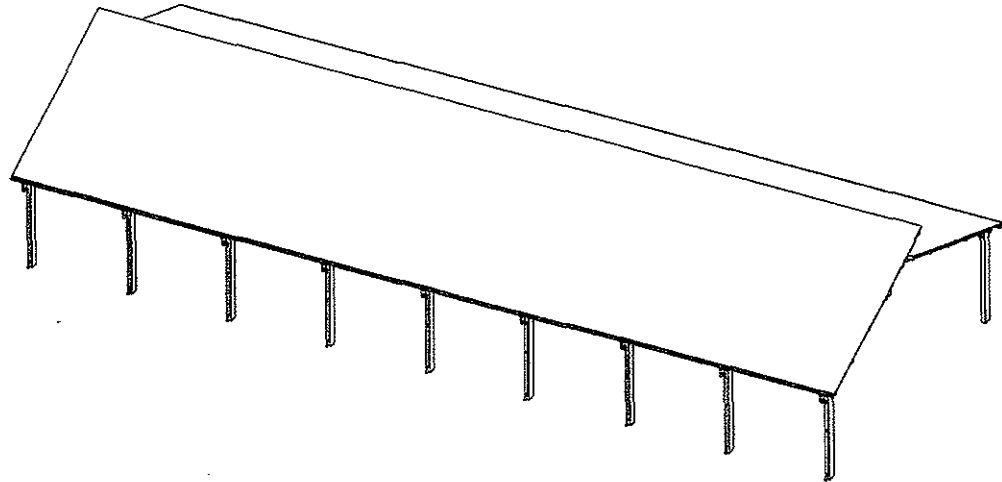

FABRICATOR APPROVALS:
 CITY OF PHOENIX, AZ APPROVED FABRICATOR #C08-2010
 CITY OF LOS ANGELES, CA APPROVED FABRICATOR #1596
 CITY OF RIVERSIDE, CA APPROVED FABRICATOR #SP06-0033
 CITY OF HOUSTON, TX APPROVED FABRICATOR #470
 CLARK COUNTY, NV APPROVED FABRICATOR #264
 STATE OF UTAH APPROVED FABRICATOR 02008-14

CERTIFICATES:
 MIAMI-DADE COUNTY CERTIFICATE OF COMPETENCY NO. 18-1025-01
 PCI (POWDER COATING INSTITUTE) 4000 CERTIFIED

MATERIALS:

DESCRIPTION	ASTM DESIGNATION
TUBE STEEL	A500 (GRADE B)
SCHEDULE PIPE	A53 (GRADE B)
RMT PIPE	A519
LIGHT GAGE COLD FORMED	A1003 (GRADE 50)
STRUCTURAL STEEL PLATE	A36
ROOF PANELS (STEEL)	A653

GENERAL NOTES:
 UNLESS NOTED OTHERWISE, THIS STRUCTURE WAS DESIGNED TO ONLY SUPPORT WHAT IS SHOWN ON THESE DRAWINGS. POLIGON MUST BE CONTACTED IF ANYTHING ELSE IS TO BE ATTACHED TO THIS STRUCTURE (WALLS, COLUMN WRAPS, RAILINGS, ETC.) SO THE DESIGN OF THIS STRUCTURE CAN BE REVIEWED AND POSSIBLY REVISED.

UNLESS NOTED OTHERWISE, THIS STRUCTURE WAS DESIGNED ASSUMING A 2" SEPARATION BETWEEN ANY ADJACENT STRUCTURE WITH AN EAVE HEIGHT EQUAL TO OR GREATER THAN THE EAVE HEIGHT OF THIS STRUCTURE. IF THAT SEPARATION DOES NOT EXIST, POLIGON MUST BE CONTACTED SO THE DESIGN OF THIS STRUCTURE CAN BE REVIEWED AND POSSIBLY REVISED.

STRUCTURAL STEEL SHALL BE DETAILED, FABRICATED, AND ERECTED IN ACCORDANCE WITH THE LATEST EDITION OF THE AMERICAN INSTITUTE OF STEEL CONSTRUCTION (AISC) SPECIFICATION MANUAL.

ALL WELDING IS PERFORMED BY AMERICAN WELDING SOCIETY CERTIFIED WELDERS AND CONFORMS TO THE LATEST EDITION OF AWS D1.1 OR D1.3 AS REQUIRED.

PARTS SHOWN MAY BE UPGRADED DUE TO STANDARDIZED FABRICATION. REFER TO THE SHIPPING BILL OF MATERIALS FOR POSSIBLE SUBSTITUTIONS.

FOR PROPER FIELD INSTALLATION OF THE BUILDING IT IS RECOMMENDED THAT THE PRIMARY FRAME INSTALLER AND THE ROOF INSTALLER HAVE A MINIMUM FIVE (5) YEARS DOCUMENTED EXPERIENCE INSTALLING THIS TYPE OF PRODUCT.

FOR PROPER FIELD INSTALLATION OF THE BUILDING IT IS RECOMMENDED THAT ELECTRIC WIRING, IF REQUIRED, BE RUN THROUGH THE STRUCTURAL MEMBERS BEFORE THE BUILDING IS ERECTED.

STOP!!
NOT FOR CONSTRUCTION
 USE FOR PRELIMINARY
 PLANNING AND ESTIMATING
 ONLY

poligon[®] (616)399-1963 www.poligon.com
 PORTER CORP.
 CORPORATION 4256 N. 130th AVE. HOLLAND, MI 48033
 DRAWN BY: chalgre
 CHECKED BY: [blank]
 DATE: 1-19-19
 PER DATE: 2/17/2019
 JOB NO: 18929
 DRAWING NO: -E1-18929
 PROJECT: BLUE LOT SHELTER
 PROJECT LOCATION: CHICAGO, IL
 SHEET: CS

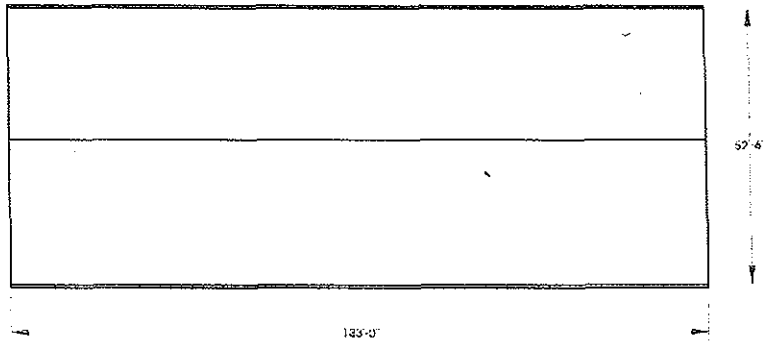

TOP VIEW

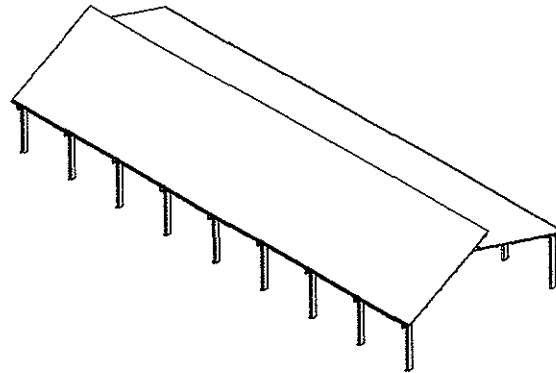

ISOMETRIC VIEW

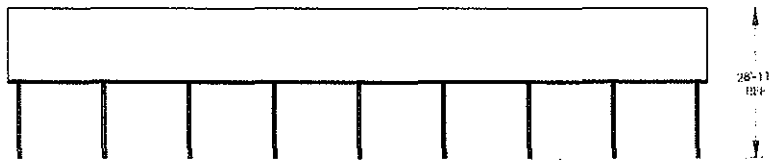

FRONT VIEW

FINISH GRADE MOUNTING VARIES BASED ON ENGINEERING REQUIREMENTS.

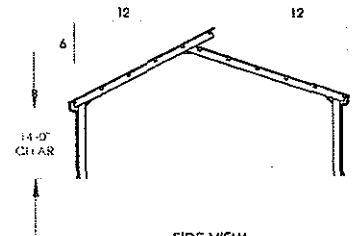

SIDE VIEW

GENERAL ROOF NOTES:

1. METAL ROOFING:
 - 24 GAUGE
 - GALVALUME COATED
 - KYNAR 500 PAINTED
2. TRIM COLOR MATCHES ROOF
3. SEE POLYGON.COM FOR COLOR OPTIONS

STOP!!
NOT FOR CONSTRUCTION

USE FOR PRELIMINARY
PLANNING AND ESTIMATING
ONLY

FINAL for ZBA
February 15, 2019

POLYGON CORPORATION 1450 N. LAUREL AVE. CHICAGO, ILL. 60642 (773) 327-1829 WWW.POLYGON.COM	DRAWN BY: CHADGIE	PROJECT NO.: 18929	SHEET NO.: 1-256
	DATE: 2/7/2019	SCALE: 1/8" = 1'-0"	DRAWING TITLE: ARCHITECTURAL ELEVATIONS
PROJECT: BLUE LOT SHELTER PROJECT LOCATION: CHICAGO, IL	CLIENT: ZBA	DATE: 02-15-2019	SHEET: 1

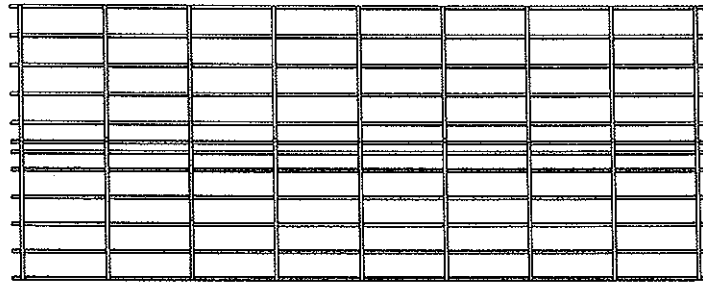

TOP VIEW

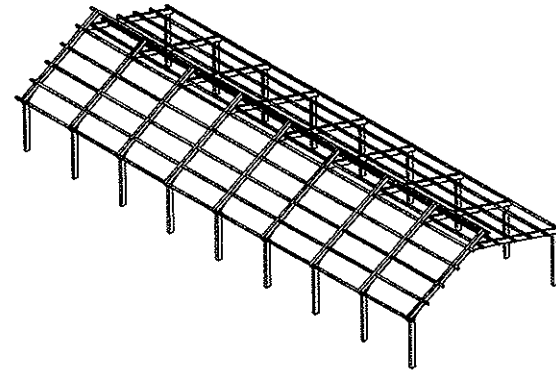

ISOMETRIC VIEW



FRONT VIEW

FINISH GRADE MOUNTING VARIES BASED ON ENGINEERING REQUIREMENTS.

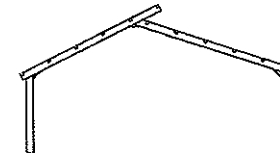

SIDE VIEW

STOP!!
NOT FOR CONSTRUCTION
USE FOR PRELIMINARY
PLANNING AND ESTIMATING
ONLY

FINAL for ZBA
February 15, 2019

PROJECT: BLUE LOT SHELTER	DATE: 2/7/2019	REVISION: A	SCALE: 1/256	BY: chogite	DATE: 2/7/2019
LOCATION: CHICAGO, IL	DRAWING NO: 18929	PROJECT NO: 18929	PROJECT NAME: BLUE LOT SHELTER	PROJECT LOCATION: CHICAGO, IL	PROJECT NO: 18929
STRUCTURAL FRAMING PLAN					
2					

poligon
POLYGON ARCHITECTURE
616.399.1963
www.poligon.com
by **PORTERCORP**

BASEPLATE NOTES:

1. POLIGON ENGINEERING WILL DETERMINE REQUIRED BASEPLATE DESIGN AFTER ENGINEERING PACKAGE IS ORDERED.
2. CUSTOMER MAY SUGGEST PREFERRED BASEPLATE DESIGN.

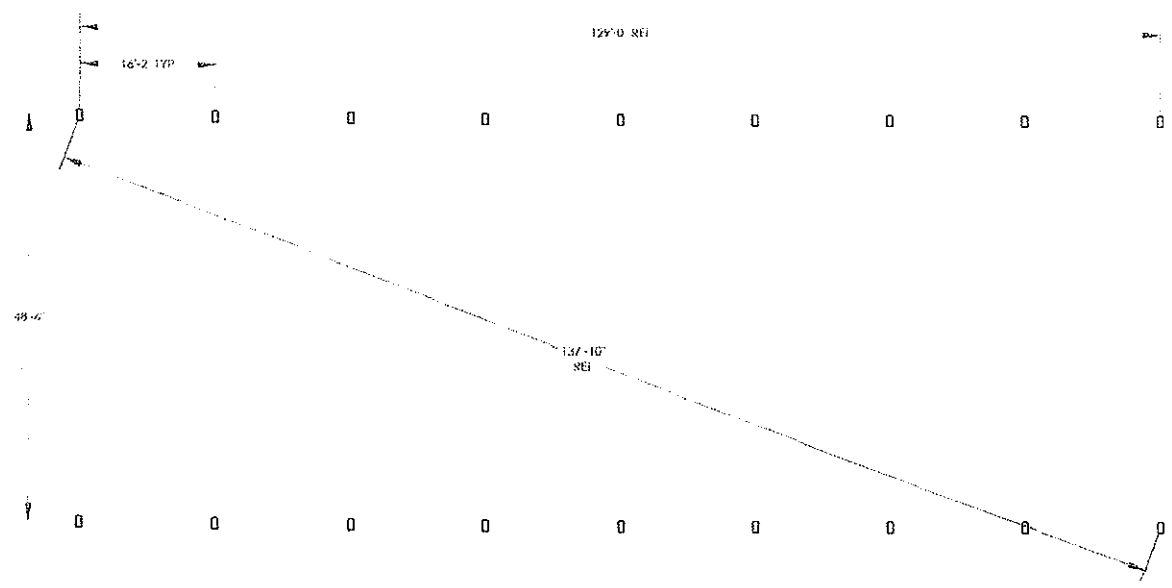

STOP!!
 NOT FOR CONSTRUCTION
 USE FOR PRELIMINARY
 PLANNING AND ESTIMATING
 ONLY

FINAL for ZBA
 February 15, 2019

PROJECT: BLUE LOT SHELTER 1000 S. LA SALLE ST. CHICAGO, IL	DATE: 2/15/19	DRAWN BY: CFC919	RECTIFIER: CFC
DRAWING: COLUMN LAYOUT	DATE: 2/7/2019	SCALE: 1/8" = 1'-0"	PROJECT NO: 11160
SHEET: 3	DATE: 1/18/19	SCALE: 1/8" = 1'-0"	PROJECT NO: 11160
POLYGON ENGINEERING, INC. 1616 399-1943 www.polygon.com by PORTERCORP			

poligon[®]

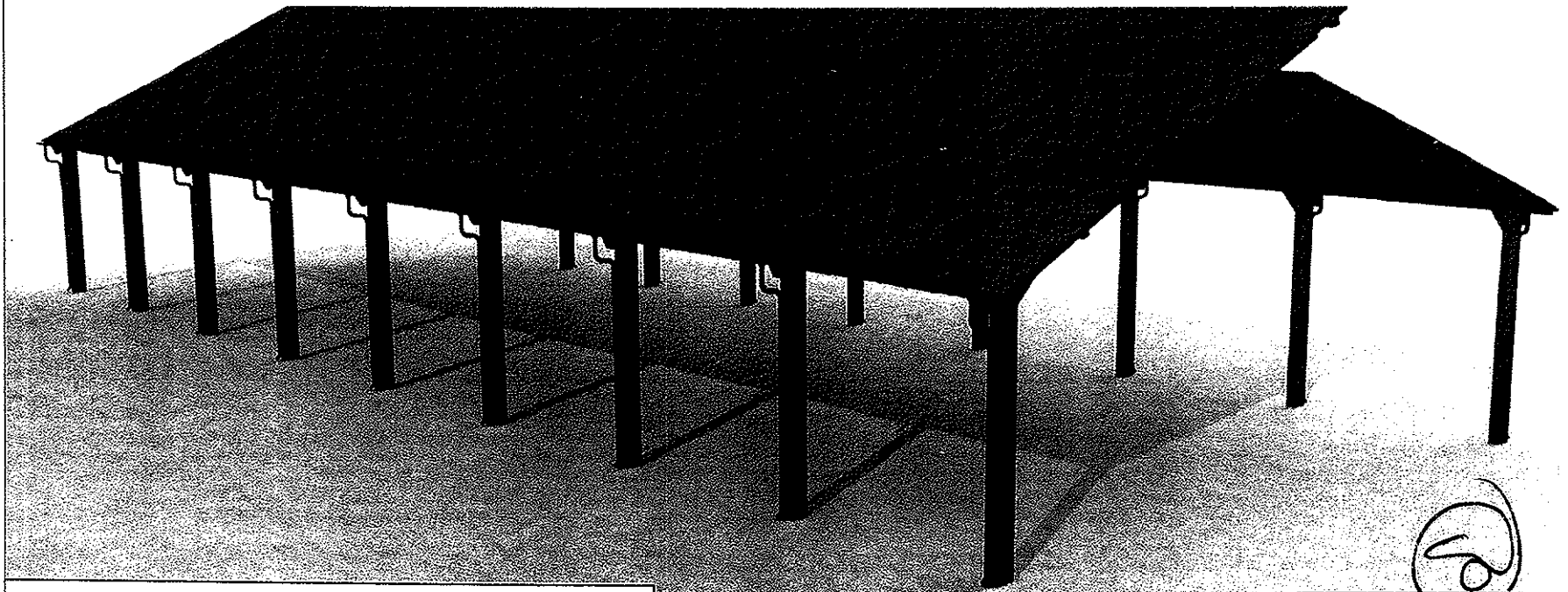

STRUCTURE SIZE: 53' Wide x 133' Long
(28' 11" Tall at peak with 14' Clearance Height at Bays)
FRAME: Steel with Poli-5000 powder coat finish.
FRAME COLOR: Hunter Green with Texture
PRIMARY ROOF: 2" x 6" Tongue & Groove Wood / Clear Sealer
SECONDARY ROOF: Asphalt Shingles / Dual Black Color



FINAL for ZBA
February 15, 2019

BLUE LOT SHELTER
CHICAGO, IL
NSL-53X133

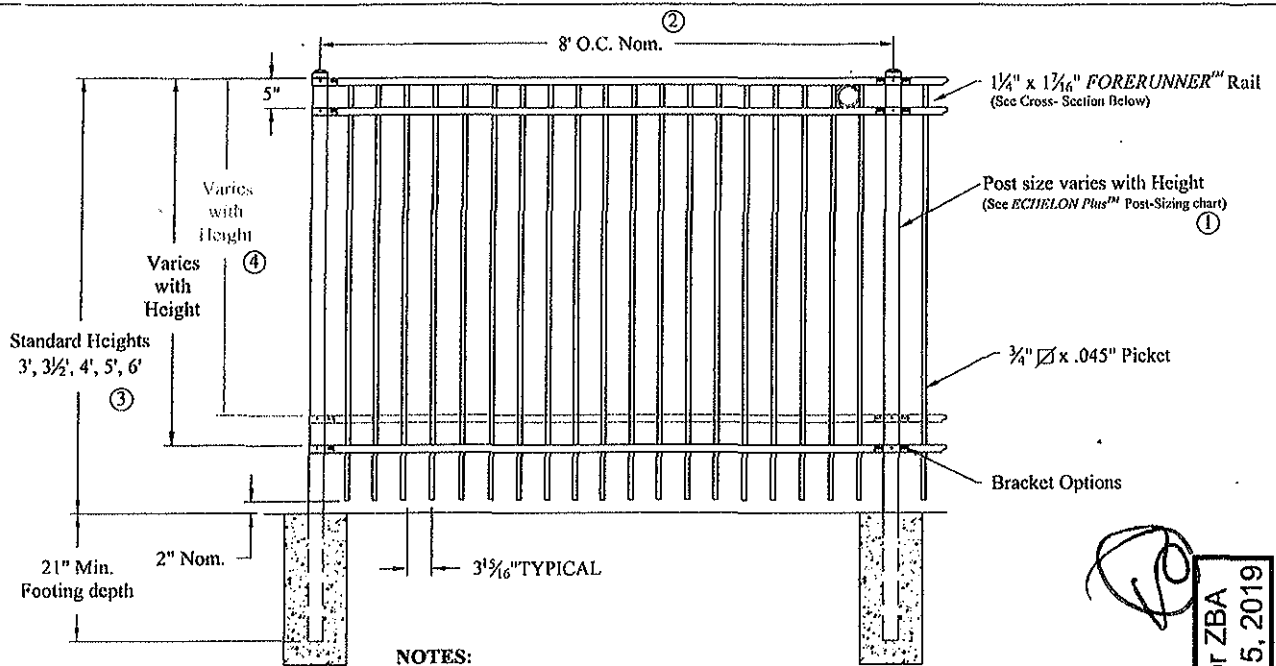

NOTES:

- 1.) Post size depends on fence height and wind loads. See ECHELON Plus™ post sizing chart.
- 2.) Panels also available for 6' on center post spacing
- 3.) Additional heights available on request
- 4.) Fourth rail optional.

FINAL for ZBA
 February 15, 2019

RING OPTION

Held in place with upper and lower internal retaining rods to eliminate unsightly external fasteners.

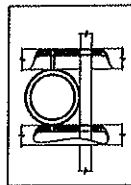

PANEL BRACKET

Specially designed two-point connection ensures fixity of rail ends for increased strength.

INTERNAL RETAINING ROD

Variable pitch connection system for ease of installation, high angle bias ability and elimination of unsightly external fasteners.

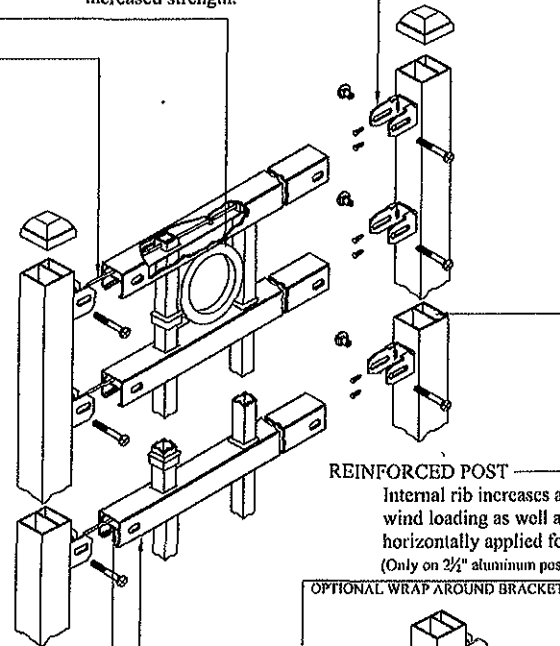
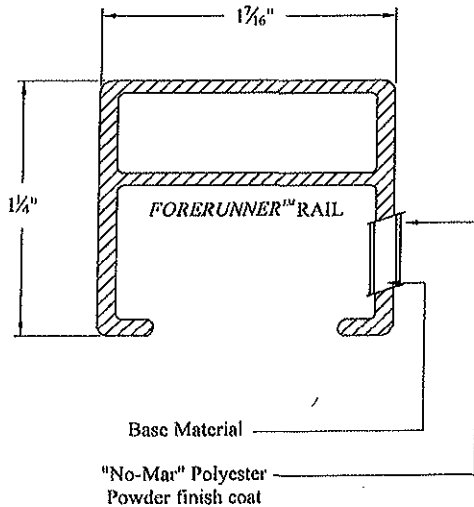

INTERIOR GUIDE CHANNEL
Channel forms lower limit of raceway for retaining rod and allows for high angle bias ability.

FORERUNNER™ RAIL

"U"-Channel specially formed high strength architectural shape.

OPTIONAL WRAP AROUND BRACKET

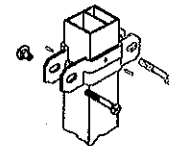

Values shown are nominal and not to be used for installation purposes. See product specification for installation requirements.

AMISO

COMMERCIAL STRENGTH ALUMINUM

Title: **ECHELON PLUS MAJESTIC 3/4-RAIL W/RING OPTION**

R: CI	SH. 1 of 1	SCALE: DO NOT SCALE
CK: BS	Date 11-8-11	REV: d



AMERISTAR®

1555 N. Mingo
 Tulsa, OK 74116
 1-888-333-3422
 www.ameristarfence.com

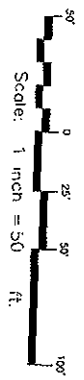
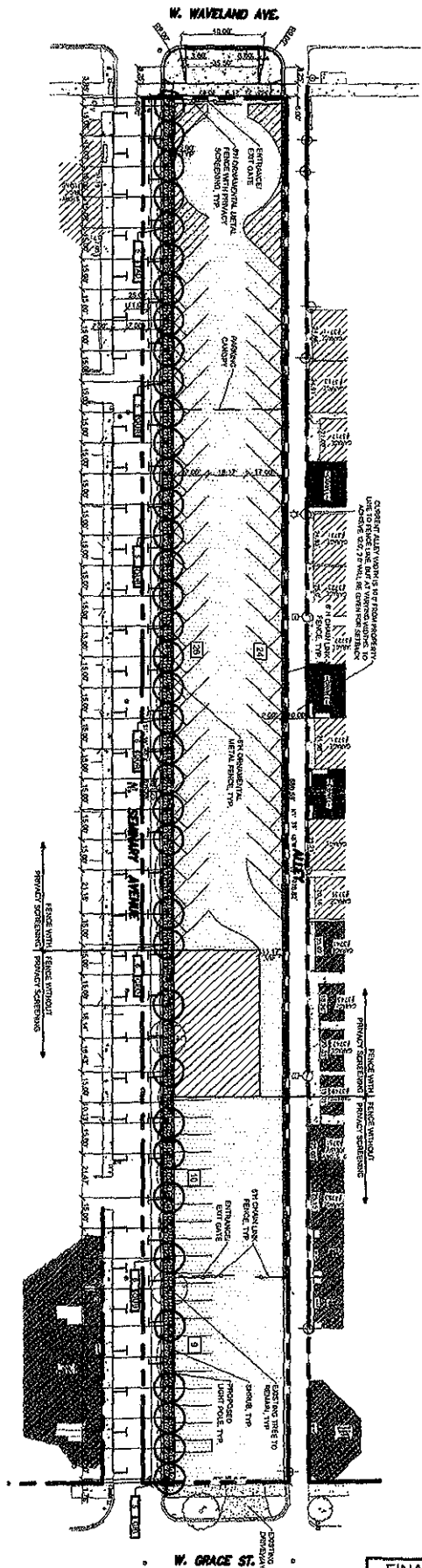

FINAL for ZBA
February 15, 2019

REV	DATE	DESCRIPTION	BY	CHKD
1	02/15/19	ISSUE FOR PERMIT	CSK	CSK
2	02/15/19	REVISIONS TO PERMIT	CSK	CSK
3	02/15/19	REVISIONS TO PERMIT	CSK	CSK
4	02/15/19	REVISIONS TO PERMIT	CSK	CSK
5	02/15/19	REVISIONS TO PERMIT	CSK	CSK

TERRA ENGINEERING LTD.
2201 W. 145th St., Suite 100
Oakbrook Terrace, IL 60181
708.485.0000

PROPOSED SITE PLAN
CHICAGO CUBS BLUE LOT - CHICAGO, IL
02/11/2019 RWK

CSK-1

ZONING BOARD OF APPEALS, CITY OF CHICAGO, CITY HALL, ROOM 905

APPLICANT: Tauhida Melendez dba House of Thrones Events **CAL NO.:** 22-18-Z

APPEARANCE FOR: Same as Applicant

MINUTES OF MEETING:
February 15, 2019

APPEARANCE AGAINST: None

PREMISES AFFECTED: 6528 W. North Avenue

NATURE OF REQUEST: Application for a variation to establish a public place of amusement license to provide live entertainment, music, DJ and cover charge within an event space which is located within 125' of a residential zoning district.

ACTION OF BOARD-
Dismissed for Want of Prosecution

MAR 18 2019
CITY OF CHICAGO
ZONING BOARD OF APPEALS

SHAINA DOAR
SOL FLORES
SAM TOIA
AMANDA WILLIAMS

AFFIRMATIVE	NEGATIVE	ABSENT
X		
X		
X		
X		

APPROVED AS TO SUBSTANCE

CHAIRMAN

ZONING BOARD OF APPEALS, CITY OF CHICAGO, CITY HALL, ROOM 905

APPLICANT: Hans Kebritchi

CAL NO.: 28-19-Z

APPEARANCE FOR: Thomas Moore

MINUTES OF MEETING:
February 15, 2019

APPEARANCE AGAINST: None

PREMISES AFFECTED: 714 N. Wells Street

NATURE OF REQUEST: Application for a variation to reduce the rear setback from the required 30' to 1.96' for a proposed rear three-story addition with roof deck and roof deck and attached three car garage for the existing three-story mixed use building.

**ACTION OF BOARD-
VARIATION GRANTED**

THE VOTE

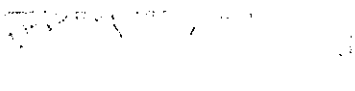
 MAR 18 2019
 CITY OF CHICAGO
 ZONING BOARD OF APPEALS

SHAINA DOAR
SOL FLORES
SAM TOIA
AMANDA WILLIAMS

AFFIRMATIVE	NEGATIVE	ABSENT
X		
X		
X		
X		

THE RESOLUTION:

WHEREAS, a public hearing was held on this application by the Zoning Board of Appeals at its regular meeting held on February 15, 2019 after due notice thereof as provided under Section 17-13-0107B and by publication in the Chicago Tribune on January 4, 2019; and

WHEREAS, the Zoning Board of Appeals, having reviewed the proposed finding of fact and having fully heard the testimony and arguments of the parties and being fully advised in the premises, hereby finds the following; the applicant shall be permitted to reduce the rear setback to 1.96' for a proposed rear three-story addition with roof deck and roof deck and attached three car garage for the existing three-story mixed use building; an additional variation was granted to the subject property in Cal. No. 29-19-Z; the Board finds 1) strict compliance with the regulations and standards of this Zoning Ordinance would create practical difficulties or particular hardships for the subject property; 2) the requested variation is consistent with the stated purpose and intent of this Zoning Ordinance; 3) the property in question cannot yield a reasonable return if permitted to be used only in accordance with the standards of this Zoning Ordinance; 4) the practical difficulties or particular hardships are due to unique circumstances and are not generally applicable to other similarly situated property; and 5) the variation, if granted will not alter the essential character of the neighborhood; it is therefore

RESOLVED, that the Zoning Board of Appeals, by virtue of the authority conferred upon it, does hereby make a variation in the application of the district regulations of the zoning ordinance and that the aforesaid variation request be and it hereby is granted subject to the following condition(s):

That all applicable ordinances of the City of Chicago shall be complied with before a permit is issued.

APPROVED AS TO SUBSTANCE

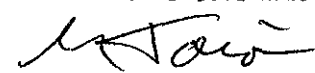

 CHAIRMAN

ZONING BOARD OF APPEALS, CITY OF CHICAGO, CITY HALL, ROOM 905

APPLICANT: Hans Kebritchi

CAL NO.: 29-19-Z

APPEARANCE FOR: Thomas Moore

MINUTES OF MEETING:
February 15, 2019

APPEARANCE AGAINST: None

PREMISES AFFECTED: 714 N. Wells Street

NATURE OF REQUEST: Application for a variation to reduce the required off street parking spaces from two to one for a proposed rear three-story addition with roof deck and stairs and an attached one car garage for the existing three-story mixed use building.

**ACTION OF BOARD-
VARIATION GRANTED**

THE VOTE



SHAINA DOAR
SOL FLORES
SAM TOIA
AMANDA WILLIAMS

AFFIRMATIVE	NEGATIVE	ABSENT
X		
X		
X		
X		

THE RESOLUTION:

WHEREAS, a public hearing was held on this application by the Zoning Board of Appeals at its regular meeting held February 15, 2019 after due notice thereof as provided under Section 17-13-0107B and by publication in the Chicago Sun-Times on January 4, 2019; and

WHEREAS, the Zoning Board of Appeals, having reviewed the proposed finding of fact and having fully heard the testimony and arguments of the parties and being fully advised in the premises, hereby finds the following; the applicant shall be permitted to reduce the required off street parking spaces to one for a proposed rear three-story addition with roof deck and stairs and an attached one car garage for the existing three-story mixed use building; an additional variation was granted to the subject property in Cal. No. 28-19-Z; the Board finds 1) strict compliance with the regulations and standards of this Zoning Ordinance would create practical difficulties or particular hardships for the subject property; 2) the requested variation is consistent with the stated purpose and intent of this Zoning Ordinance; 3) the property in question cannot yield a reasonable return if permitted to be used only in accordance with the standards of this Zoning Ordinance; 4) the practical difficulties or particular hardships are due to unique circumstances and are not generally applicable to other similarly situated property; and 5) the variation, if granted will not alter the essential character of the neighborhood; it is therefore

RESOLVED, that the Zoning Board of Appeals, by virtue of the authority conferred upon it, does hereby make a variation in the application of the district regulations of the zoning ordinance and that the aforesaid variation request be and it hereby is granted subject to the following condition(s):

That all applicable ordinances of the City of Chicago shall be complied with before a permit is issued.

APPROVED AS TO SUBSTANCE



 act. CHAIRMAN

ZONING BOARD OF APPEALS, CITY OF CHICAGO, CITY HALL, ROOM 905

APPLICANT: Board of Education

CAL NO.: 33-19-Z

APPEARANCE FOR: Scott Borstein

MINUTES OF MEETING:
February 15, 2019

APPEARANCE AGAINST: None

PREMISES AFFECTED: 6530 W. Bryn Mawr Avenue

NATURE OF REQUEST: Application for a variation to reduce the rear setback from the required 50' to 11.33', south side setback from 28.75' to 16.17' (north to be 28.75'), for proposed accessory recreational equipment including a turf field with backstop, bleachers with pressbox, light poles, 20' high chain link fence, and two new tennis courts to serve the existing high school.

**ACTION OF BOARD-
VARIATION GRANTED**

THE VOTE

MAR 18 2019
CITY OF CHICAGO
ZONING BOARD OF APPEALS

SHAINA DOAR
SOL FLORES
SAM TOIA
AMANDA WILLIAMS

AFFIRMATIVE	NEGATIVE	ABSENT
X		
X		
X		
X		

THE RESOLUTION:

WHEREAS, a public hearing was held on this application by the Zoning Board of Appeals at its regular meeting held February 15, 2019 after due notice thereof as provided under Section 17-13-0107B and by publication in the Chicago Sun-Times on January 4, 2019; and

WHEREAS, the Zoning Board of Appeals, having reviewed the proposed finding of fact and having fully heard the testimony and arguments of the parties and being fully advised in the premises, hereby finds the following; the applicant shall be permitted to reduce the rear setback to 11.33', south side setback to 16.17' (north to be 28.75'), for proposed accessory recreational equipment including a turf field with backstop, bleachers with pressbox, light poles, 20' high chain link fence, and two new tennis courts to serve the existing high school; the Board finds 1) strict compliance with the regulations and standards of this Zoning Ordinance would create practical difficulties or particular hardships for the subject property; 2) the requested variation is consistent with the stated purpose and intent of this Zoning Ordinance; 3) the property in question cannot yield a reasonable return if permitted to be used only in accordance with the standards of this Zoning Ordinance; 4) the practical difficulties or particular hardships are due to unique circumstances and are not generally applicable to other similarly situated property; and 5) the variation, if granted will not alter the essential character of the neighborhood; it is therefore

RESOLVED, that the Zoning Board of Appeals, by virtue of the authority conferred upon it, does hereby make a variation in the application of the district regulations of the zoning ordinance and that the aforesaid variation request be and it hereby is granted subject to the following condition(s):

That all applicable ordinances of the City of Chicago shall be complied with before a permit is issued.

APPROVED AS TO SUBSTANCE
[Signature]
CHAIRMAN

ZONING BOARD OF APPEALS, CITY OF CHICAGO, CITY HALL, ROOM 905

APPLICANT: Avi Ron

CAL NO.: 61-19-Z

APPEARANCE FOR: John Pikarski

MINUTES OF MEETING:
February 15, 2019

APPEARANCE AGAINST: None

PREMISES AFFECTED: 2939-47 W. Catalpa Avenue

NATURE OF REQUEST: Application for a variation to reduce the front setback from the required 22.88' to 20', east setback from 12.01' to 1.47', west setback from 12.01' to 6.41' combined side setback from 36.02' to 7.88' to divide an existing zoning lot into two zoning lots. The existing building at 2939 W. Catalpa shall remain. A single family residence is proposed for 2947 W. Catalpa.

ACTION OF BOARD-
Continued to March 15, 2019 at 9:00 a.m.

MAR 18 2019
CITY OF CHICAGO
ZONING BOARD OF APPEALS

SHAINA DOAR
SOL FLORES
SAM TOIA
AMANDA WILLIAMS

AFFIRMATIVE	NEGATIVE	ABSENT
X		
X		
X		
X		

APPROVED AS TO SUBSTANCE

CHAIRMAN

ZONING BOARD OF APPEALS, CITY OF CHICAGO, CITY HALL, ROOM 905

APPLICANT: Jack Tusk **CAL NO.:** 62-19-Z

APPEARANCE FOR: Tyler Manic **MINUTES OF MEETING:**

February 15, 2019

APPEARANCE AGAINST: None

PREMISES AFFECTED: 5343 N. Wayne Avenue

NATURE OF REQUEST: Application for a variation to reduce the rear setback from the required 36.9' to 1.59', north and south side setback from 2.4' to zero each, combined side setback from 6' to zero, rear setback feature from 2' to 1.59' for a proposed three-car garage with roof deck access from an existing rear open porch.

ACTION OF BOARD-
Continued to March 15, 2019 at 9:00 a.m.

MAR 18 2019
CITY OF CHICAGO
ZONING BOARD OF APPEALS

SHAINA DOAR
SOL FLORES
SAM TOIA
AMANDA WILLIAMS

AFFIRMATIVE	NEGATIVE	ABSENT
X		
X		
X		
X		

APPROVED AS TO SUBSTANCE

CHAIRMAN

ZONING BOARD OF APPEALS, CITY OF CHICAGO, CITY HALL, ROOM 905

APPLICANT: Big Blue Swim School

CAL NO.: 75-19-Z

APPEARANCE FOR: Same as Applicant

MINUTES OF MEETING:
February 15, 2019

APPEARANCE AGAINST: None

PREMISES AFFECTED: 4207 N. Western Ave.

NATURE OF REQUEST: Application for a variation to reduce the east setback from the required 6.7' to zero for a proposed 8.25' high solid fence along the east property line on a lot containing an existing one-story building.

**ACTION OF BOARD-
VARIATION GRANTED**

THE VOTE

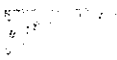
 MAR 18 2019
 CITY OF CHICAGO
 ZONING BOARD OF APPEALS

SHAINA DOAR
 SOL FLORES
 SAM TOIA
 AMANDA WILLIAMS

AFFIRMATIVE	NEGATIVE	ABSENT
X		
X		
X		
X		

THE RESOLUTION:

WHEREAS, a public hearing was held on this application by the Zoning Board of Appeals at its regular meeting held on February 15, 2019 after due notice thereof as provided under Section 17-13-0107B and by publication in the Chicago Sun-Times on January 4, 2019; and

WHEREAS, the Zoning Board of Appeals, having reviewed the proposed finding of fact and having fully heard the testimony and arguments of the parties and being fully advised in the premises, hereby finds the following; the applicant shall be permitted to reduce the east setback to zero for a proposed 8.25' high solid fence along the east property line on a lot containing an existing one-story building; the Board finds 1) strict compliance with the regulations and standards of this Zoning Ordinance would create practical difficulties or particular hardships for the subject property; 2) the requested variation is consistent with the stated purpose and intent of this Zoning Ordinance; 3) the property in question cannot yield a reasonable return if permitted to be used only in accordance with the standards of this Zoning Ordinance; 4) the practical difficulties or particular hardships are due to unique circumstances and are not generally applicable to other similarly situated property; and 5) the variation, if granted will not alter the essential character of the neighborhood; it is therefore

RESOLVED, that the Zoning Board of Appeals, by virtue of the authority conferred upon it, does hereby make a variation in the application of the district regulations of the zoning ordinance and that the aforesaid variation request be and it hereby is granted subject to the following condition(s):

That all applicable ordinances of the City of Chicago shall be complied with before a permit is issued.

APPROVED AS TO SUBSTANCE

 act. CHAIRMAN

ZONING BOARD OF APPEALS, CITY OF CHICAGO, CITY HALL, ROOM 905

APPLICANT: 2805 Eastwood, LLC

CAL NO.: 528-18-Z

APPEARANCE FOR: Nicholas Ftikas

MINUTES OF MEETING:
February 15, 2019

APPEARANCE AGAINST: None

PREMISES AFFECTED: 2805 W. Eastwood Avenue

NATURE OF REQUEST: Application for a variation to reduce the front setback from the required 54.417' to 28.093', east setback from 4' to 3' (west to be 4'), combined side setback from 9' to 7', rear setback from 33.60' to 28.093', rear yard open space from 400 square feet to 268 square feet for a proposed two-story, single family residence.

ACTION OF BOARD-
Continued to April 19, 2019 at 9:00 a.m.

THE VOTE

MAR 18 2019
CITY OF CHICAGO
ZONING BOARD OF APPEALS

SHAINA DOAR
SOL FLORES
SAM TOIA
AMANDA WILLIAMS

AFFIRMATIVE	NEGATIVE	ABSENT
X		
X		
X		
X		

APPROVED AS TO SUBSTANCE

CHAIRMAN

ZONING BOARD OF APPEALS, CITY OF CHICAGO, CITY HALL, ROOM 905

APPLICANT: Shoreditch, LLC **CAL NO.:** 622-18-Z(A)
APPEARANCE FOR: Sara Barnes **MINUTES OF MEETING:**
APPEARANCE AGAINST: None February 15, 2019
PREMISES AFFECTED: 3259 N. Racine Avenue

NATURE OF REQUEST: Application for a variation to reduce the front setback from the required 14.84' to 5' for a proposed three-story, three dwelling unit building.

ACTION OF BOARD-
Continued to March 15, 2019 at 9:00 a.m.

MAR 18 2019
CITY OF CHICAGO
ZONING BOARD OF APPEALS

SHAINA DOAR
SOL FLORES
SAM TOIA
AMANDA WILLIAMS

AFFIRMATIVE	NEGATIVE	ABSENT
X		
X		
X		
X		

ZONING BOARD OF APPEALS, CITY OF CHICAGO, CITY HALL, ROOM 905

APPLICANT: Shoreditch, LLC **CAL NO.:** 623-18-Z(A)
APPEARANCE FOR: Sara Barnes **MINUTES OF MEETING:**
APPEARANCE AGAINST: None February 15, 2019
PREMISES AFFECTED: 3259 N. Racine Avenue

NATURE OF REQUEST: Application for a variation to reduce the minimum lot area per dwelling unit from 1,000 to 993.32 (which is less than 10%) for a proposed Three-story, three dwelling unit building.

ACTION OF BOARD-
Continued to March 15, 2019 at 9:00 a.m.

MAR 18 2019
CITY OF CHICAGO
ZONING BOARD OF APPEALS

SHAINA DOAR
SOL FLORES
SAM TOIA
AMANDA WILLIAMS

AFFIRMATIVE	NEGATIVE	ABSENT
X		
X		
X		
X		