



# **CHICAGO PLAN COMMISSION**

## **Department of Planning and Development**

**THRIVE ENGLEWOOD**

**914 WEST 63RD STREET (16th Ward)**

**THRIVE ENGLEWOOD LLC**

**Developer: DL3 Realty Advisors, LLC**

*7/21/22*

# ★ Community Area Snap Shot

## COMMUNITY AREA INFORMATION:

- Englewood Neighborhood Population: 24,369
- Number of Households: 9,597
- Average Household Size: 2.5
- Percentage of population 19 and under: 29.4%
- Median Income: \$22,127

## NEIGHBORHOOD HISTORIC CONTEXT:

- Englewood's population peaked in 1960 at 81,000.
- Englewood was the home of Chicago's largest outlying shopping center at 63rd & Halsted in the early 1900's.

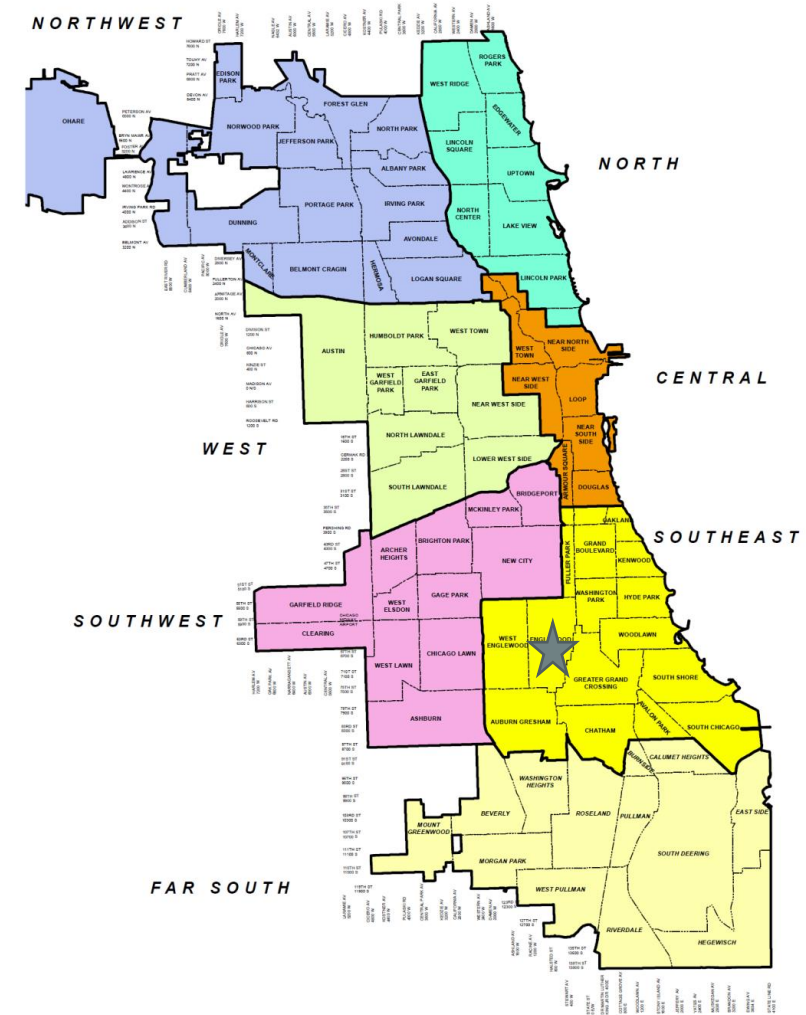

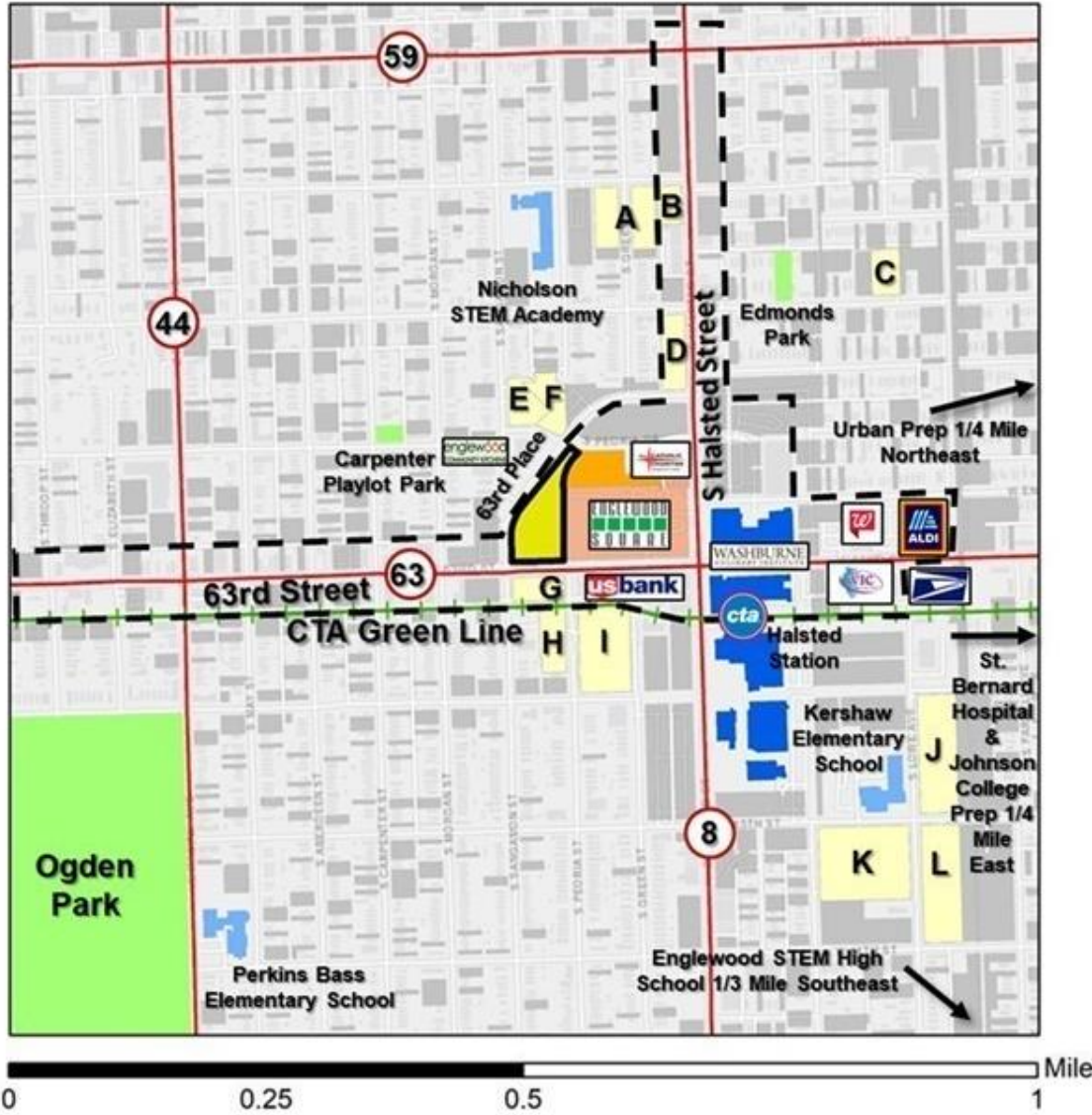

**Legend**

Proposed Site – Thrive Englewood

**Transportation Amenities (Transit-Oriented Development)**

CTA 'L' Station

CTA Green Line

CTA Bus Routes

**Institutional Amenities & Vacant Land**

Public Parks

Nearby K-12 Schools

Kennedy-King College

Vacant Lots/Lots with Abandoned Buildings

**Area Existing and Proposed Development**

DL3-Developed Site – Englewood Square Shopping Center

Businesses: Starbucks, Chipotle Mexican Grill, Villa, Dress Code, Wingstop, Nail Works, Oak Street Health, AT&T, and PNC Bank

Englewood Connect Site – INVEST South/West RFP Winner (Proposed)

Co-working space, food business incubator, community kitchens, public gathering space, a café, an outdoor plaza with green space, and restored historic firehouse.

Other Housing Investment in the Area

- A – Hope Manor Village | 36 Units, Supportive/Veterans Housing
- B – Hope Manor II Apts. | 73 Units, Supportive/Veterans Housing
- C – Victoria Jennings Residences | 24 Units, Housing for People with Disabilities
- D – KBK Apts. (Proposed) | 56 Units, Affordable Family Housing
- E – Sangamon Terrace Apts. | 24 Units, Affordable Senior Housing
- F – Bethel Terrace Apts. | 123 Units, Affordable Senior Housing
- G – Englewood Apts. | 99 Units, Supportive Housing
- H – Greencastle of Englewood | 60 Units, Senior Housing
- I – Montclare Senior Residences | 102 Units, Affordable Senior Housing
- J – New Englewood Terrace Apts. | 304 Units, Affordable Family Housing (LIHTC)
- K – Eastwood Garden Apts. | 188 Units, Affordable Family Housing
- L – Major Robert Lawrence Apts. | 193 Units, Affordable Senior Housing

Greater Englewood INVEST South/West Priority Corridor



# LAND USE CONTEXT PLAN



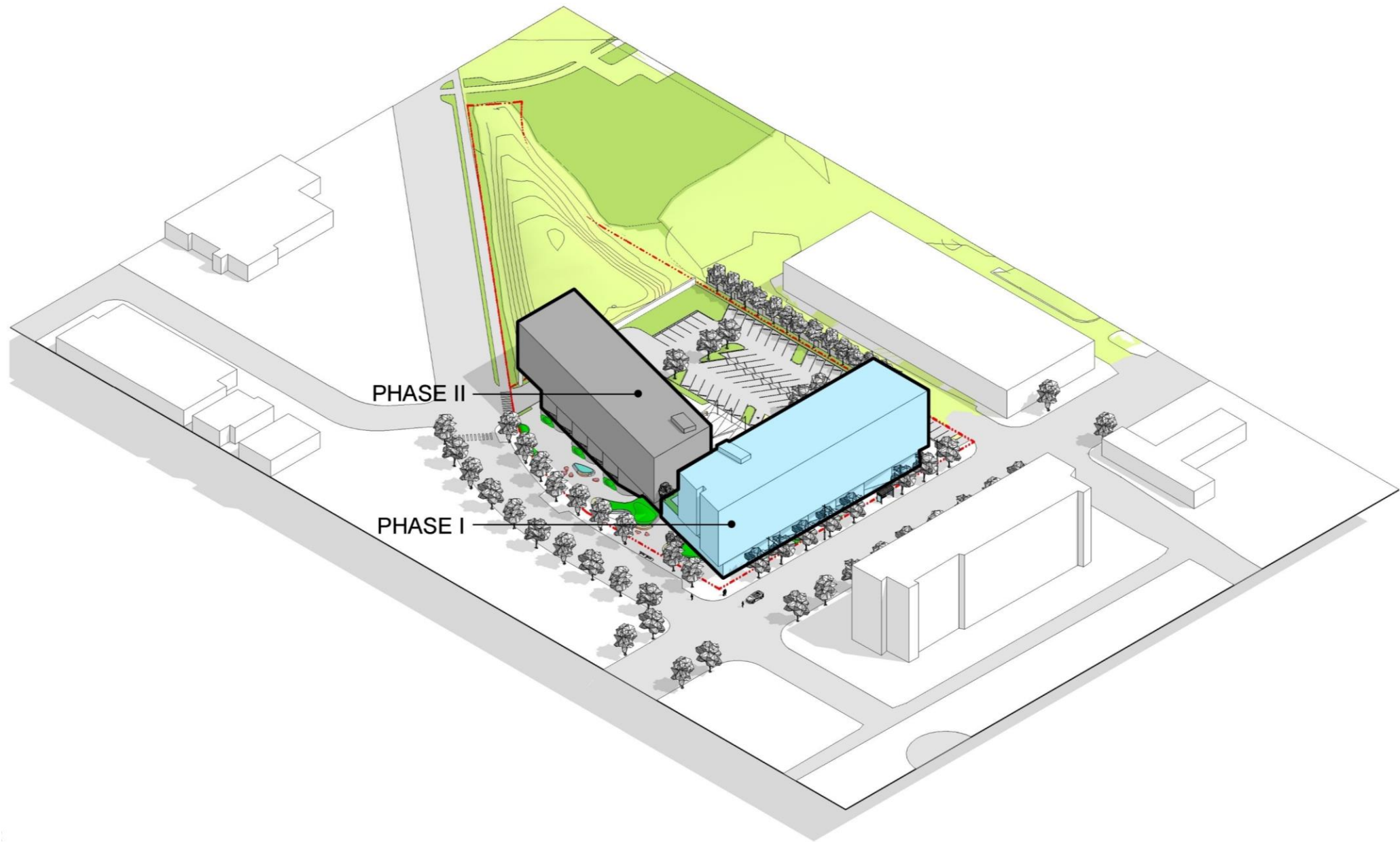

**AERIAL VIEW FROM SOUTH WEST DIRECTION**

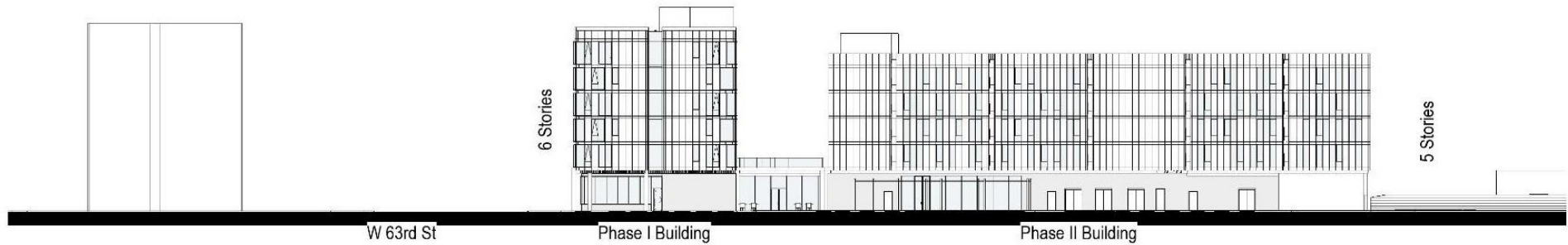

Private Alley Elevation

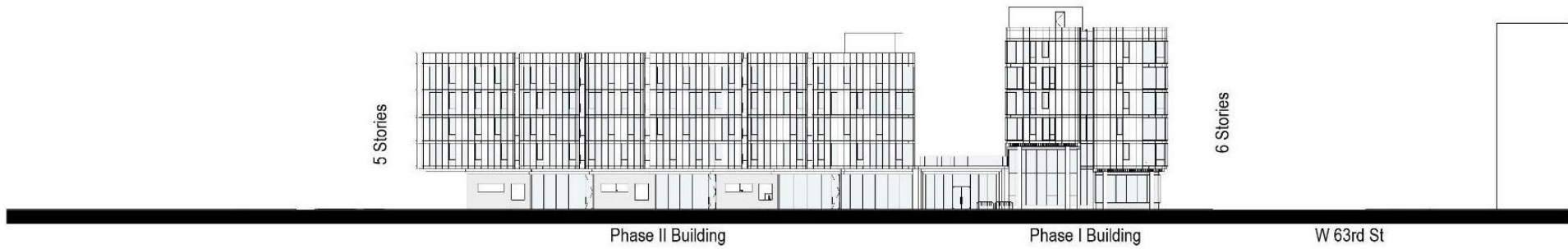

W 63rd Pkwy Elevation

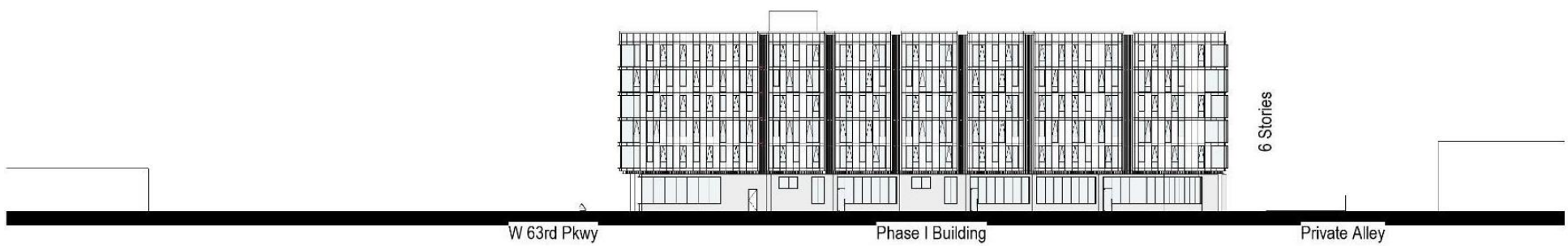

W 63rd St Elevation

# STREETSCAPE ELEVATIONS

# Pedestrian Context





# Pedestrian Context

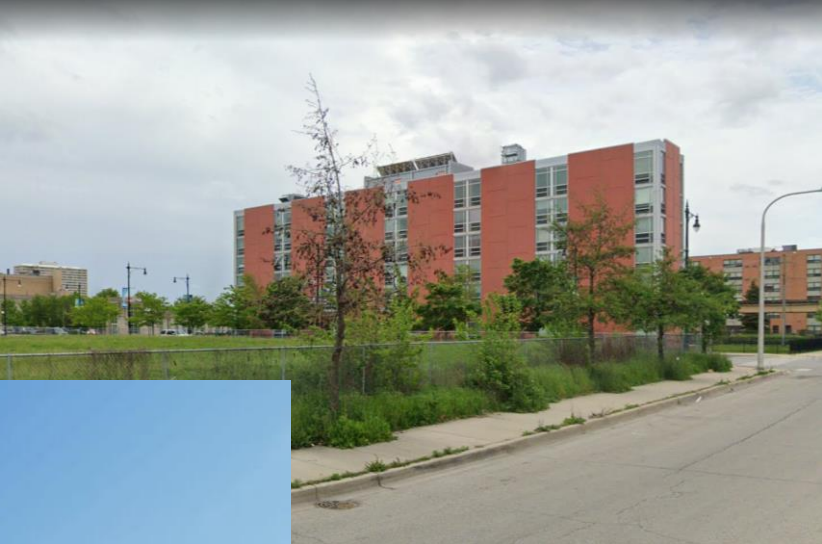

# ★ Planning Context



## INVEST South/West

- Fall 2019
- Community Improvement Initiative launched by Mayor Lori Lightfoot
- Provide Brief Outline of Plan Goals
  - Greater Englewood is one of ten neighborhood cores included in this community improvement initiative.
  - Reactivate neighborhood cores which have historically served as focal points for pedestrian activity, shopping, services, transportation, public spaces and quality of life amenities for local residents.
  - Reverse systemic trends of reduced property values, public safety concerns, vacant lots, abandoned buildings and blight by establishing targeted improvements that benefit existing residents and businesses.

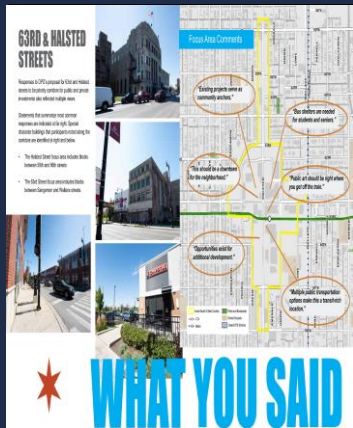

# Project Timeline + Community Outreach

- Date PD Application introduced to City Council: **April 27, 2022**
- Date(s) of Community Meeting(s):
  - November 17, 2020
  - January 25, 2021
  - January 27, 2021
  - June 16, 2021
  - June 23, 2021
  - January 12, 2022
  - May 10, 2022
  - June 11, 2022
- Project Changes Based on DPD Feedback:
  - The project team changed the design and finish of the reveals to further break down the massing along 63rd Street.
  - The project team changed the color of the brick at the base to match the dark neutral accent used at the windows frames

# Project Timeline + Community Outreach



**Before rendering**  
February 18, 2022



**After Rendering**  
April 7, 2022

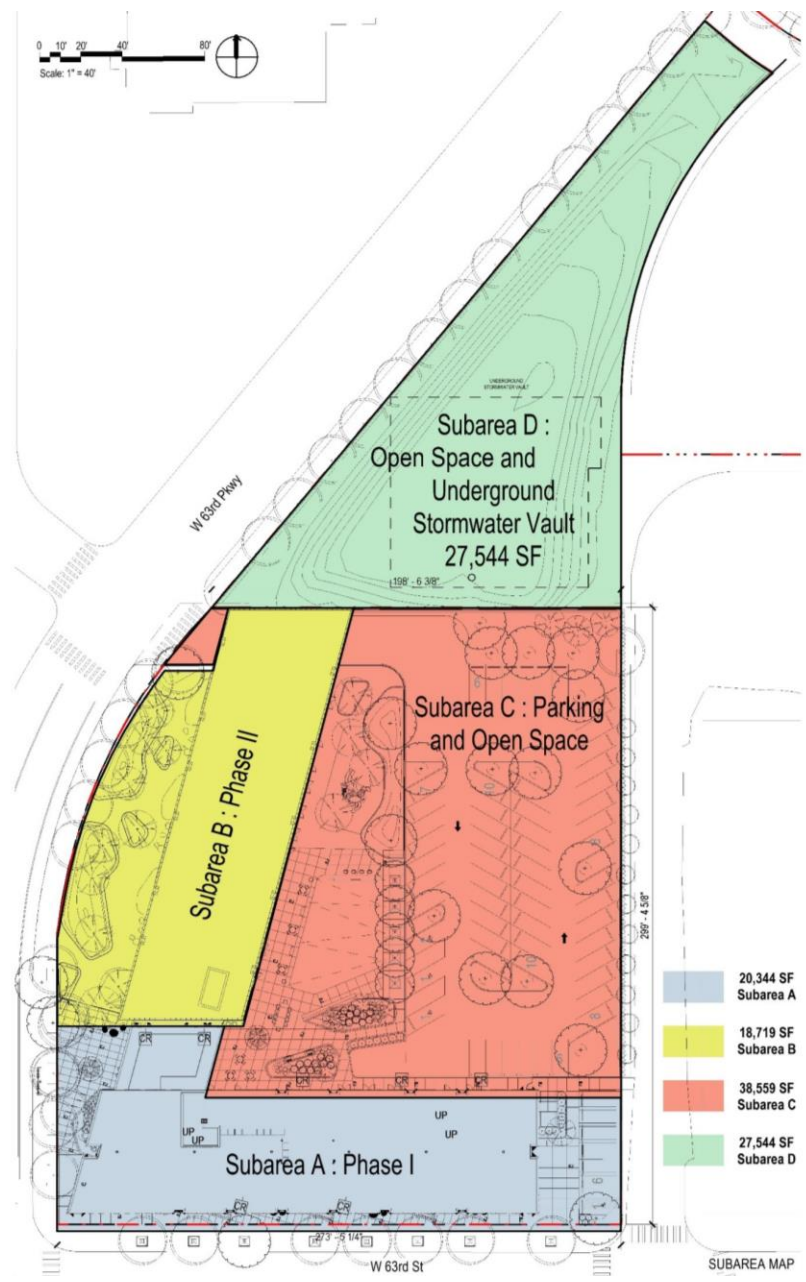

- 20,344 SF  
Subarea A
- 18,719 SF  
Subarea B
- 38,559 SF  
Subarea C
- 27,544 SF  
Subarea D

# SUBAREA MAP

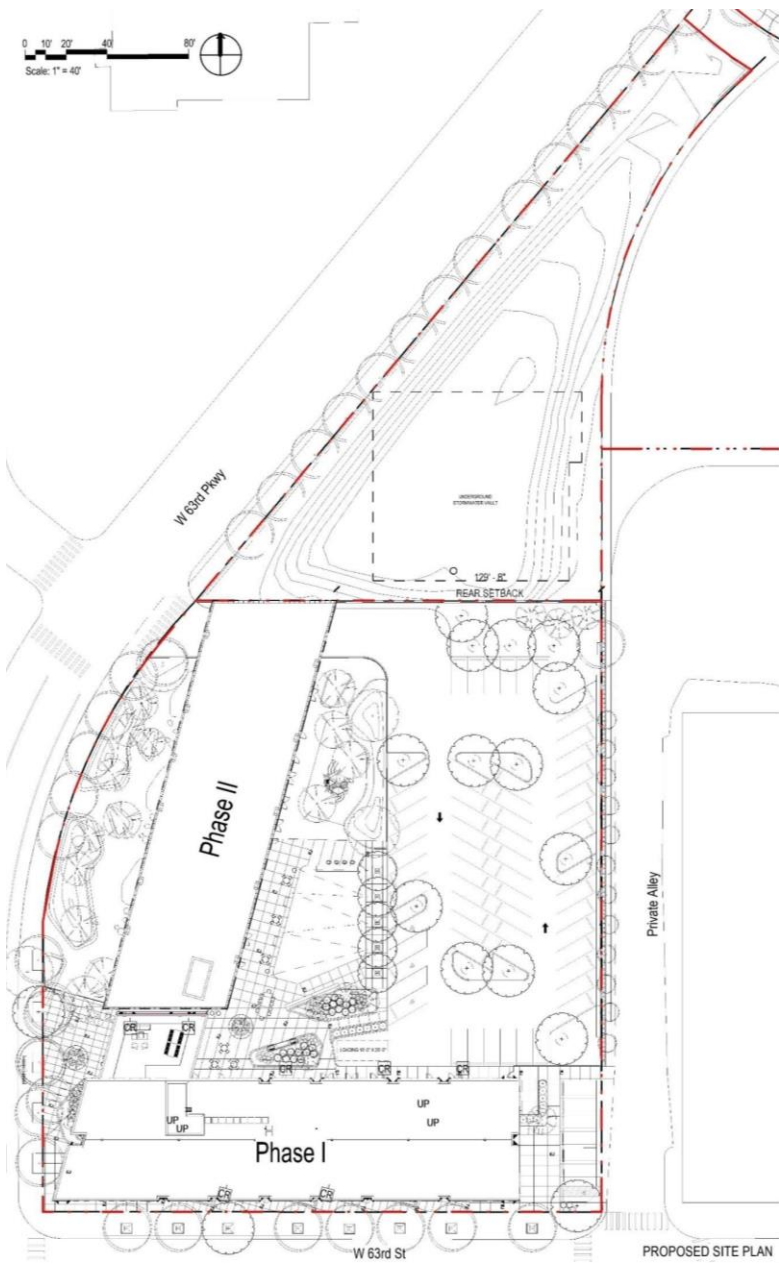

# SITE PLAN



# PHASE I - GROUND FLOOR PLAN



**PHASE I - LEVEL 2 FLOOR PLAN**





# PHASE I - LEVEL 3-6 FLOOR PLAN

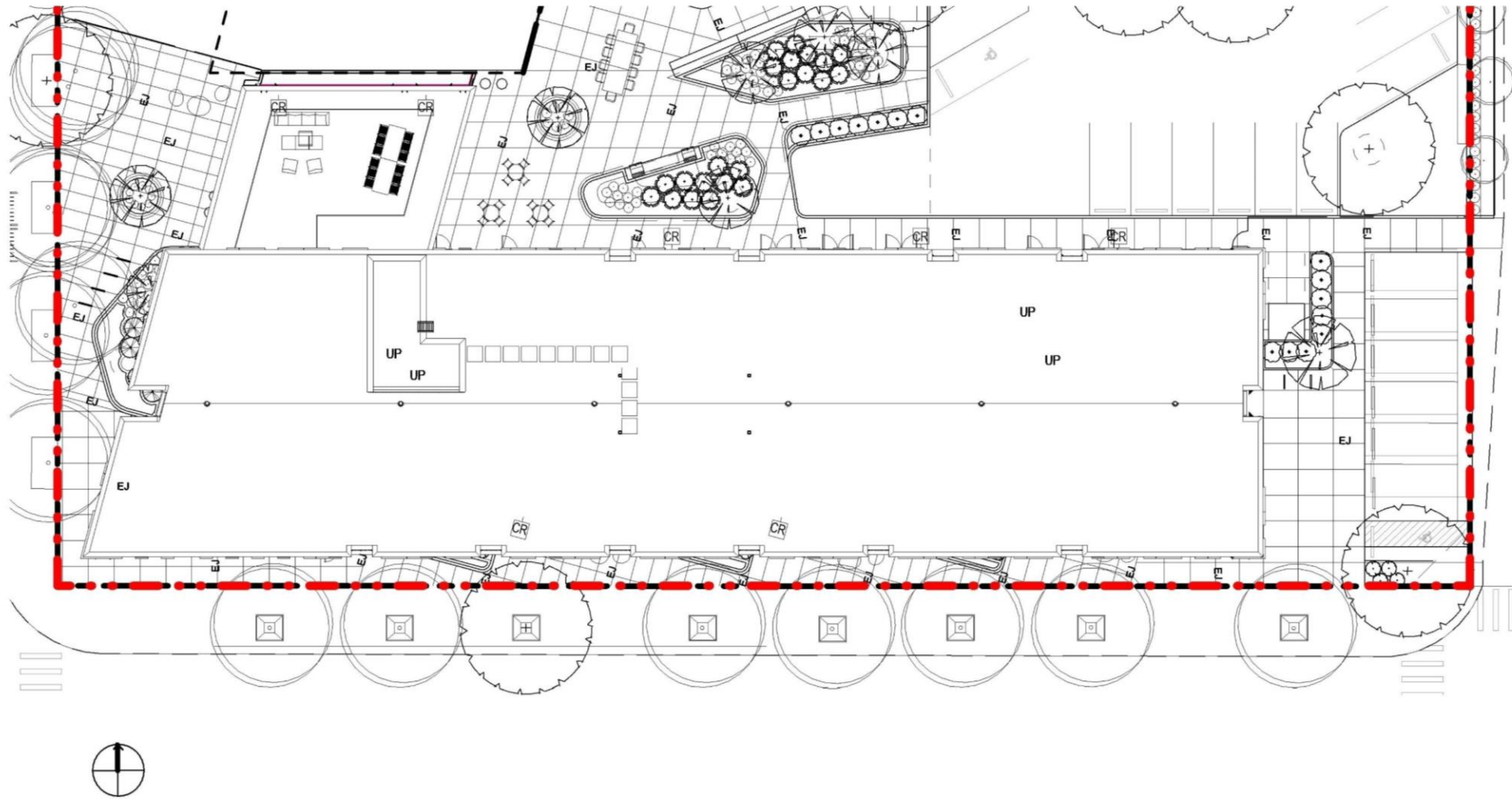

# PHASE I – ROOF PLAN



**PHASE II - GROUND FLOOR PLAN**



**PHASE II – LEVEL 2-5 FLOOR PLAN**

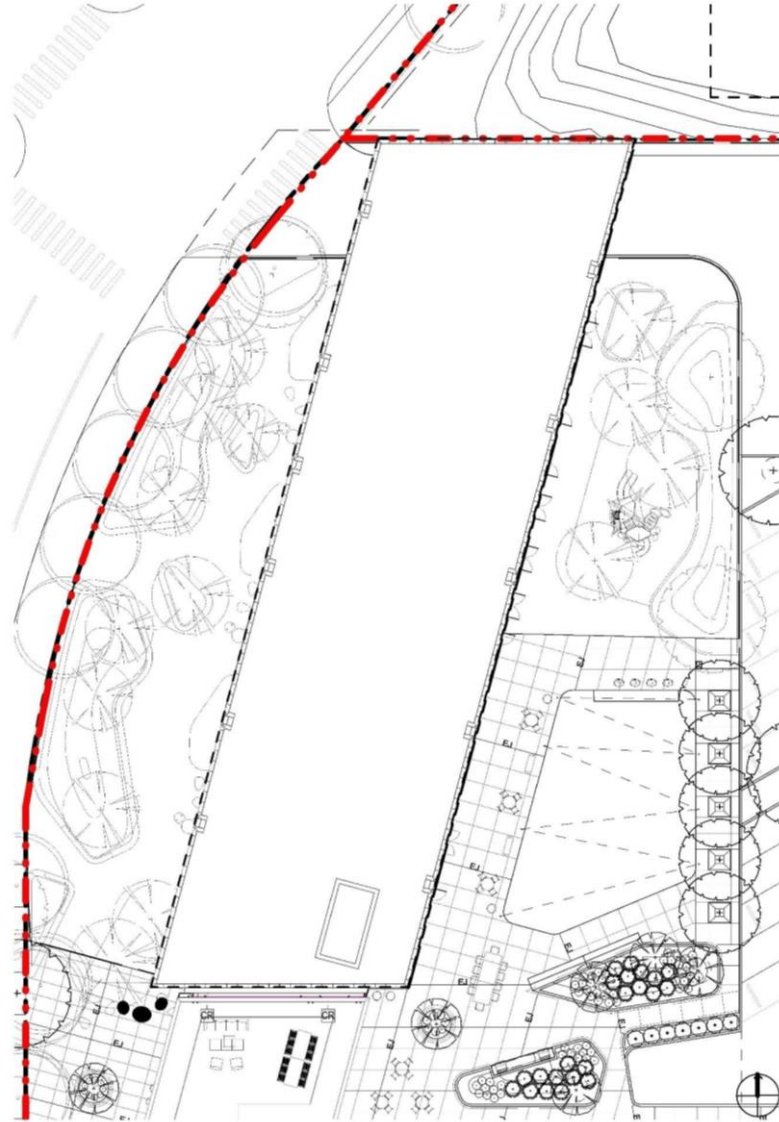

PHASE II – ROOF PLAN



**BUILDING ELEVATION – PHASE I WEST**



**BUILDING ELEVATION – PHASE I SOUTH**



# BUILDING ELEVATION – PHASE I EAST





**BUILDING ELEVATION – PHASE I NORTH**

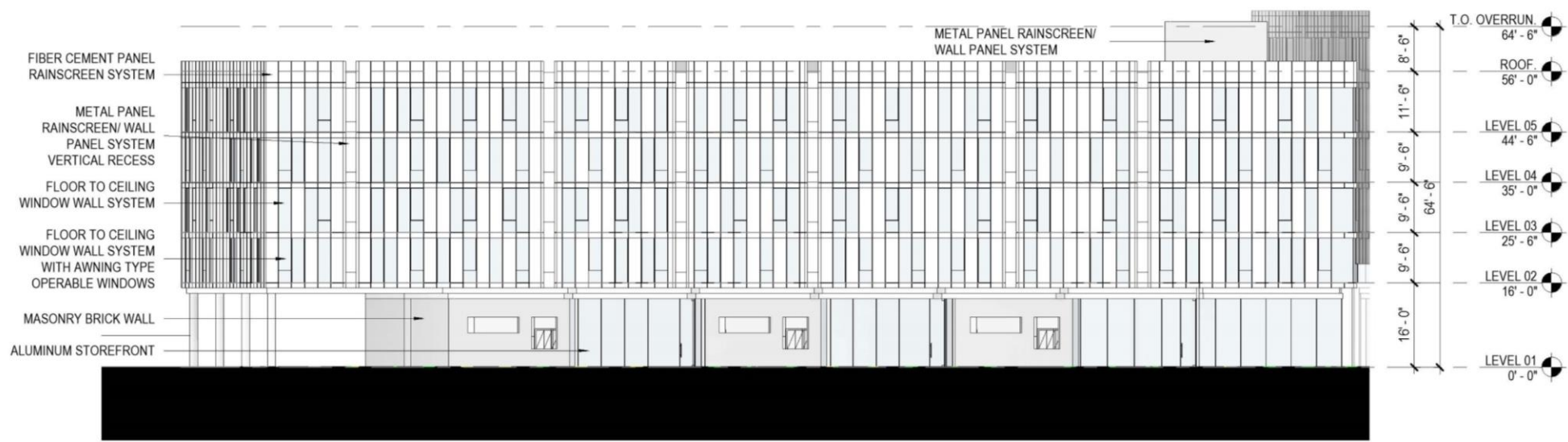

**BUILDING ELEVATION – PHASE II WEST**

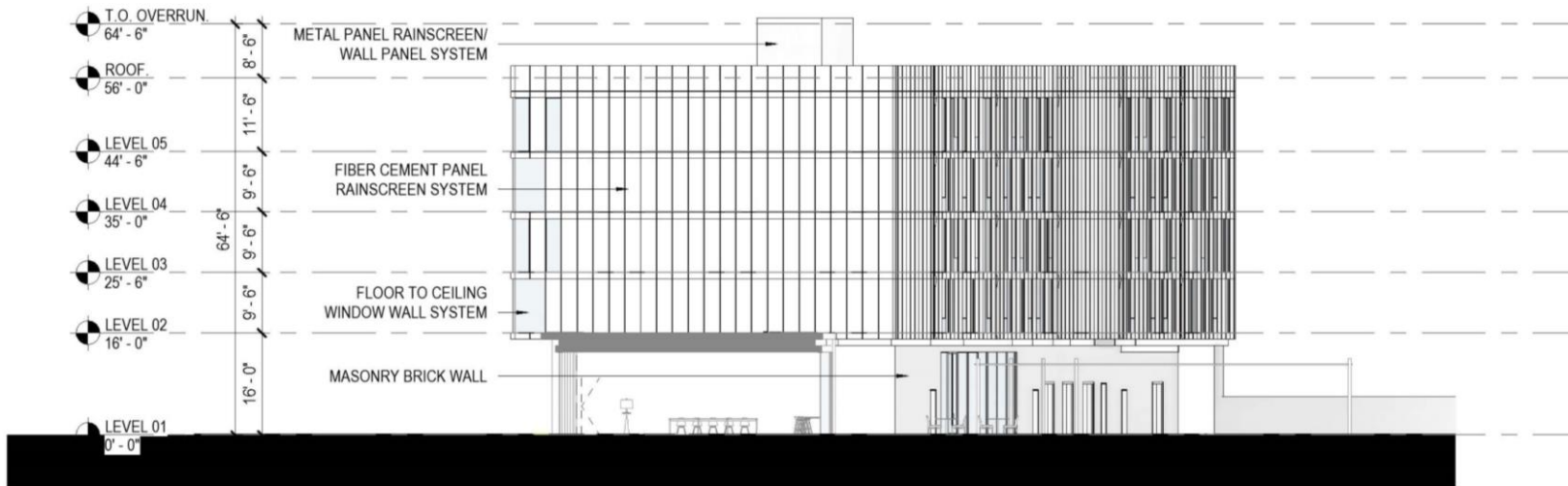

**BUILDING ELEVATION – PHASE II SOUTH**

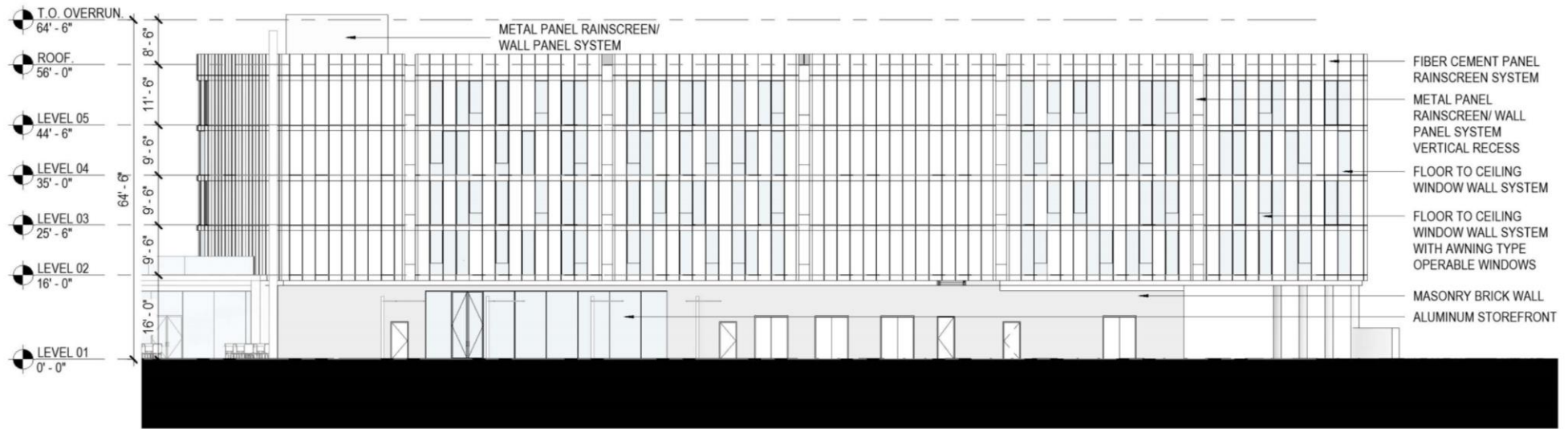

**BUILDING ELEVATION – PHASE II EAST**

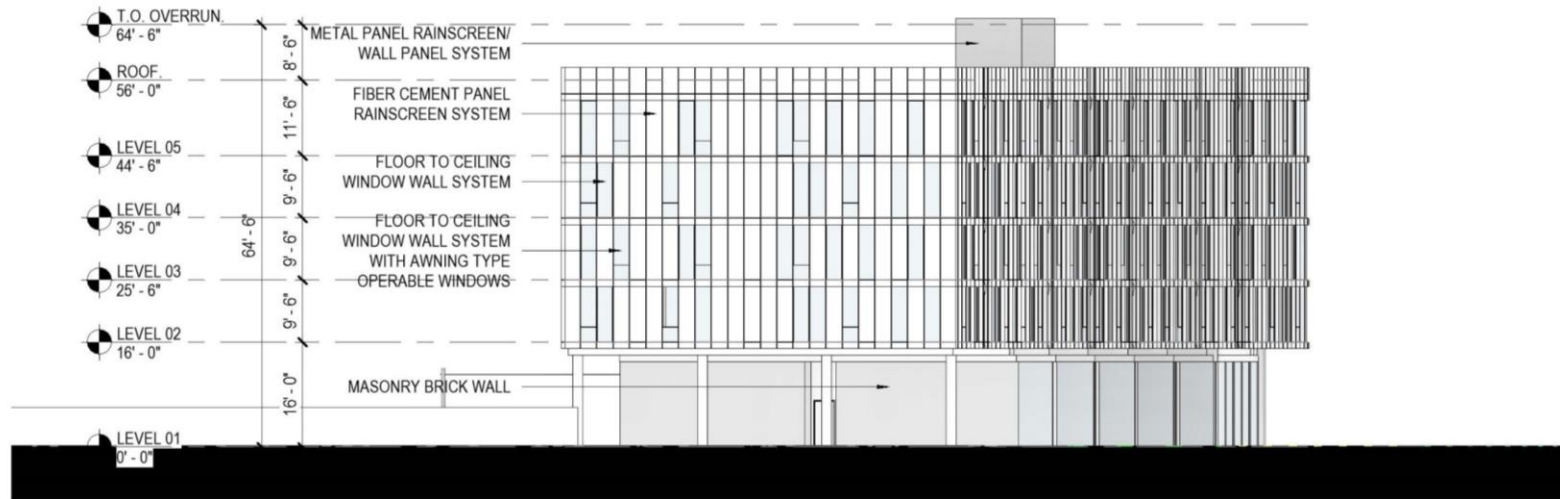

**BUILDING ELEVATION – PHASE II NORTH**



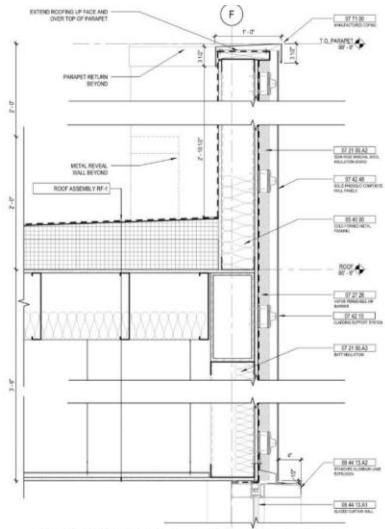

8 TYP. PARAPET AT FIBER CEMENT - AT CORNERS  
1:1/2" = 1'-0"

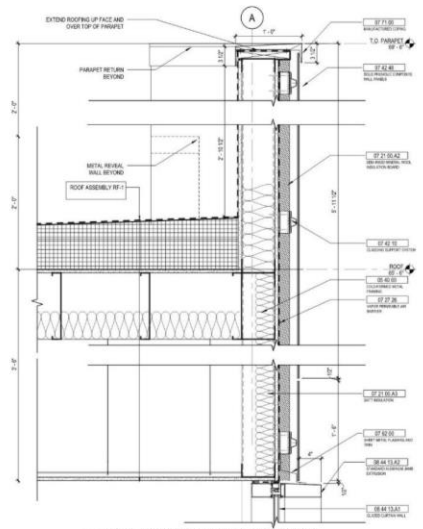

5 TYP. PARAPET AT FIBER CEMENT  
1:1/2" = 1'-0"

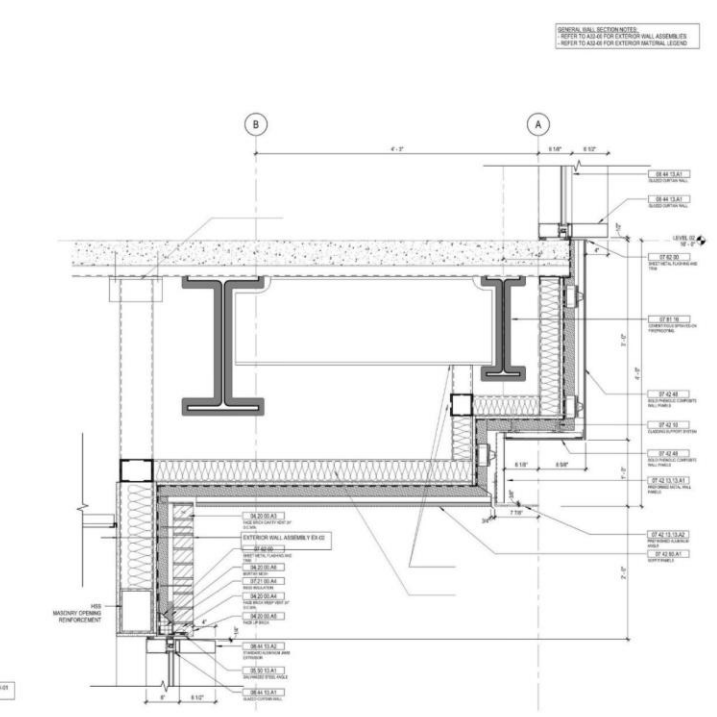

GENERAL WALL SECTION NOTES:  
REFER TO ALL OF THE EXTERIOR WALL ASSEMBLIES  
REFER TO A-6.4 FOR EXTERIOR MATERIAL LEGEND

2 RECESS AT LEVEL 1 SLAB/SOFFIT  
1:1/2" = 1'-0"

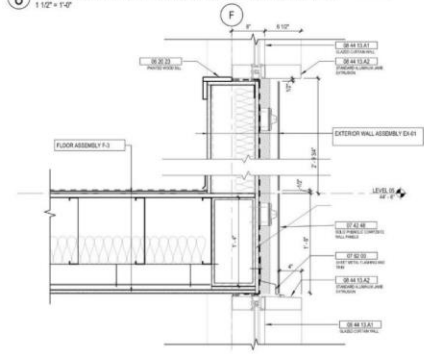

7 TYP. SLAB AT GLAZED OPENING - AT CORNERS  
1:1/2" = 1'-0"

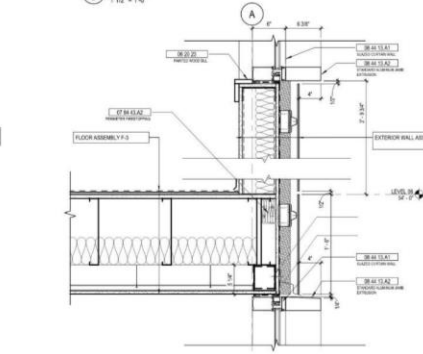

4 TYP. SLAB AT GLAZED OPENING  
1:1/2" = 1'-0"

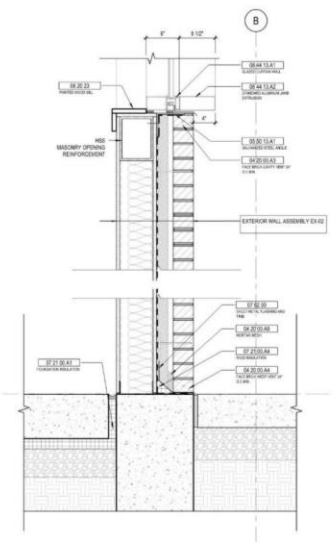

1 BRICK BASE AT WINDOW  
1:1/2" = 1'-0"

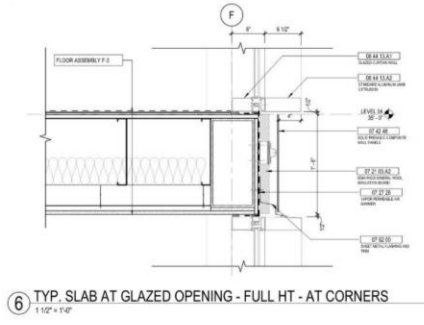

6 TYP. SLAB AT GLAZED OPENING - FULL HT - AT CORNERS  
1:1/2" = 1'-0"

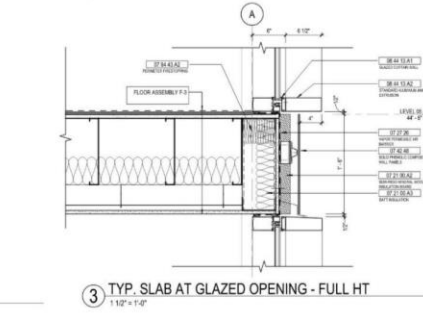

3 TYP. SLAB AT GLAZED OPENING - FULL HT  
1:1/2" = 1'-0"

- Pedestrian access to the main lobby and Phase II Live-Work units is from 63<sup>rd</sup> Parkway.
- Pedestrian access to retail and Phase I Live-Work units is from 63<sup>rd</sup> Street.
- Secure exterior bike parking (12) is provided adjacent to the main lobby and retail of Phase I building
- Additionally, the Phase II building has secure interior bike parking for residents.

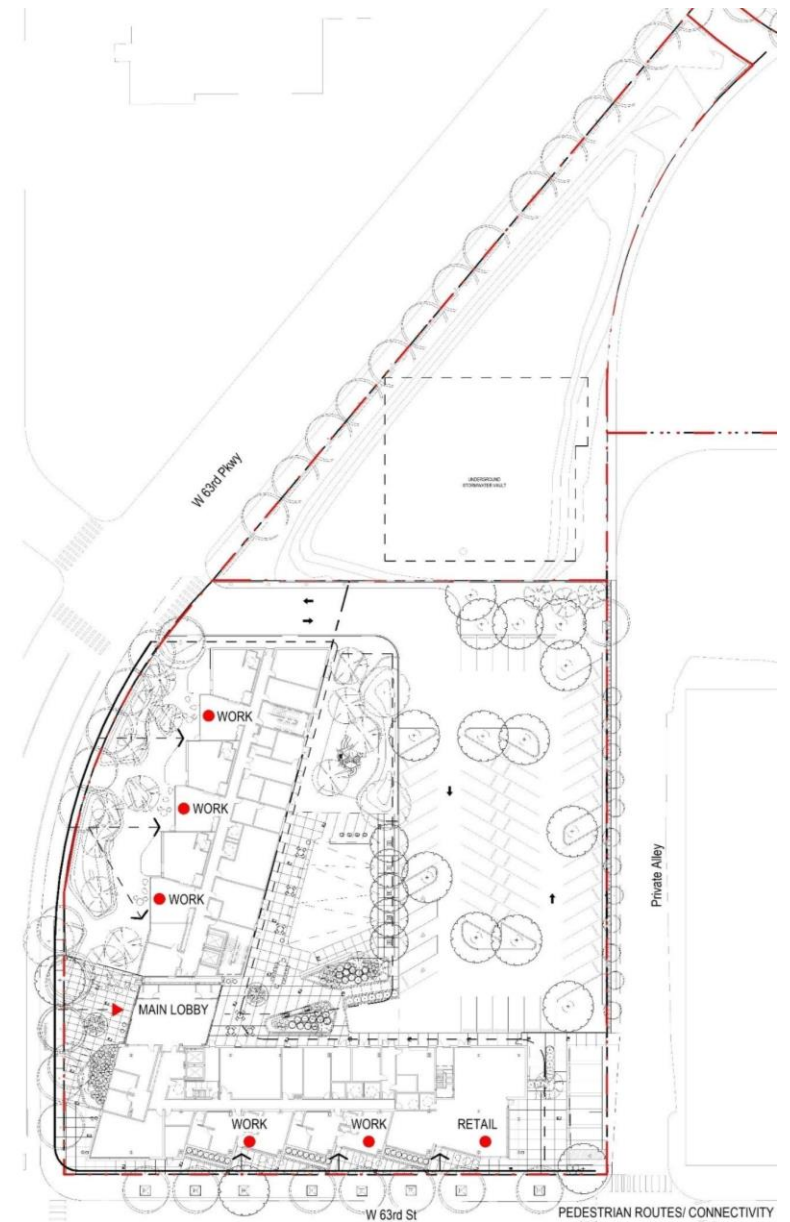



- The driveway to access the residential parking is accessed from 63<sup>rd</sup> Parkway, and aligns with Sangamon Street.
- Fifty-eight (58) residential parking spaces located behind the building.
- Seven (7) retail parking spaces will be located at the side of the building.

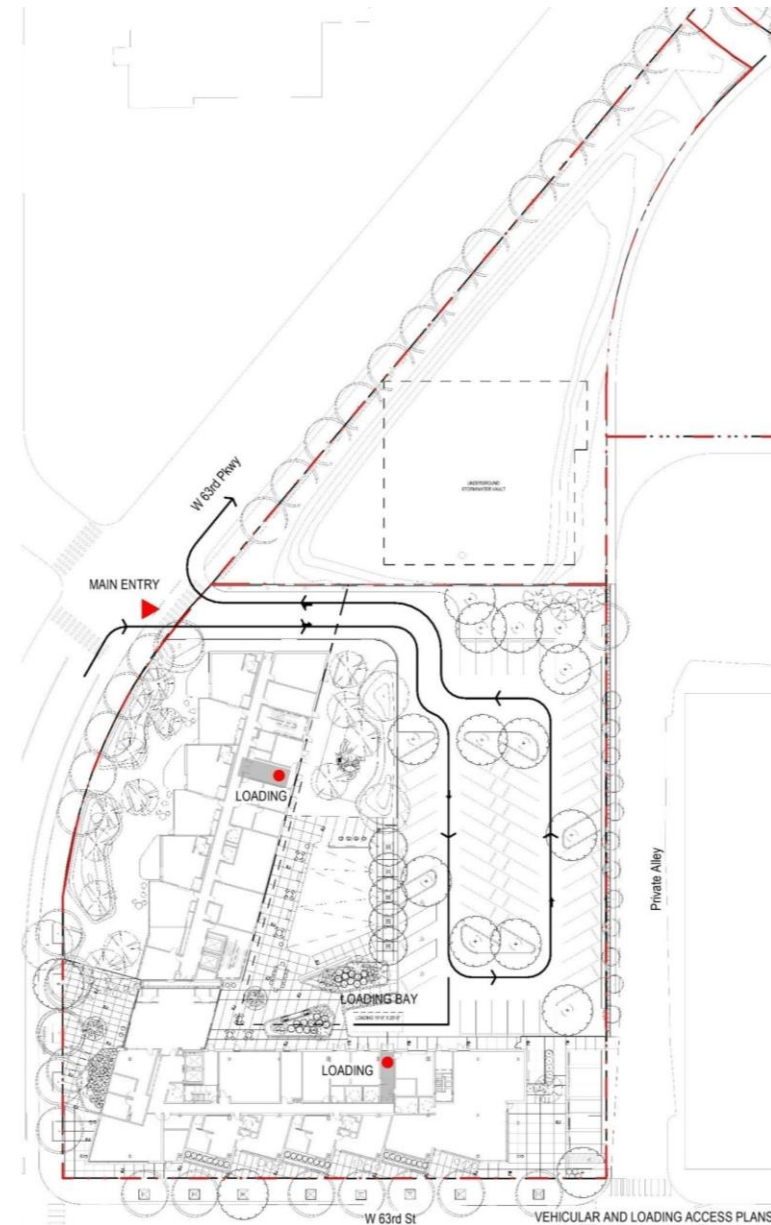

- The building massing creates a street wall along 63<sup>rd</sup> Street, and this allows for a landscaped plaza along 63<sup>rd</sup> Parkway, with parking behind the buildings accessed via 63<sup>rd</sup> Parkway.
- The street level is activated using an articulated façade, and the programming provides for active uses at sidewalk level including retail and Live-Work Units.
- The community will have access to a pocket park adjacent to retail facing 63<sup>rd</sup> Street, and residents will have access to a roof deck on level 2, as well as a private event lawn.

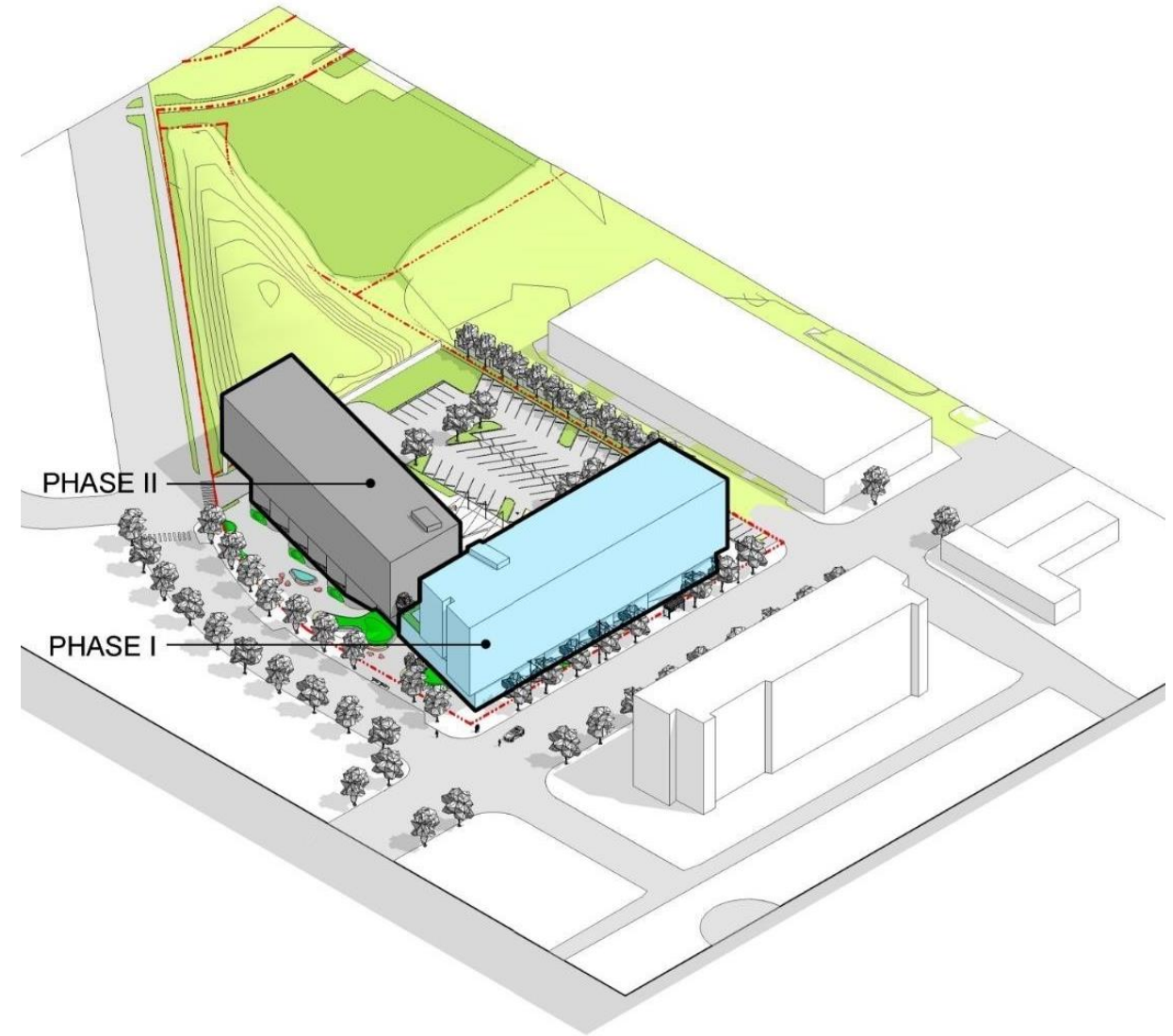

- **Plazas are provided at the main entry and adjacent to retail.**
- **Substantial landscaping is provided in Phase II along 63<sup>rd</sup> parkway.**
- **Open spaces are provided to residents behind the buildings with landscaping and tenant amenities.**
- **Open Space is provided on Subarea D.**

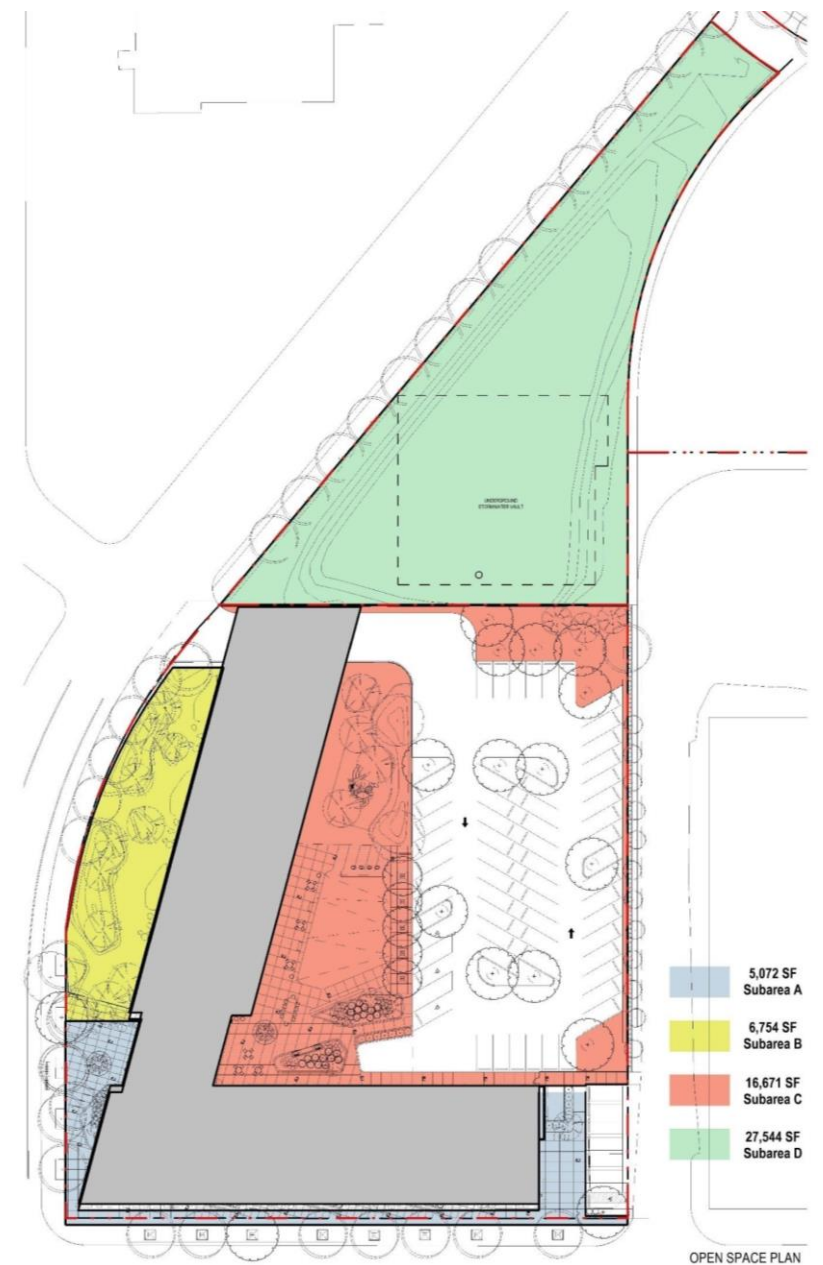

The project is compliant with the City of Chicago Landscape Ordinance per the review and approval provided by Ron Daye on June 27, 2022.

ITEM	QUANTITY	DESCRIPTION	SIZE	SPACING
1	1	Aspen	16 in x 16 in	10' x 10'
2	1	Red Maple	16 in x 16 in	10' x 10'
3	1	White Birch	16 in x 16 in	10' x 10'
4	1	Black Gum	16 in x 16 in	10' x 10'
5	1	Red Oak	16 in x 16 in	10' x 10'
6	1	White Oak	16 in x 16 in	10' x 10'
7	1	Green Ash	16 in x 16 in	10' x 10'
8	1	Boxelder	16 in x 16 in	10' x 10'
9	1	Amelanchier	16 in x 16 in	10' x 10'
10	1	Spirea	16 in x 16 in	10' x 10'
11	1	Hydrangea	16 in x 16 in	10' x 10'
12	1	Japanese Anemone	16 in x 16 in	10' x 10'
13	1	Black-eyed Susan	16 in x 16 in	10' x 10'
14	1	Coreopsis	16 in x 16 in	10' x 10'
15	1	Goldenrod	16 in x 16 in	10' x 10'
16	1	Black-eyed Susan	16 in x 16 in	10' x 10'
17	1	Black-eyed Susan	16 in x 16 in	10' x 10'
18	1	Black-eyed Susan	16 in x 16 in	10' x 10'
19	1	Black-eyed Susan	16 in x 16 in	10' x 10'
20	1	Black-eyed Susan	16 in x 16 in	10' x 10'
21	1	Black-eyed Susan	16 in x 16 in	10' x 10'
22	1	Black-eyed Susan	16 in x 16 in	10' x 10'
23	1	Black-eyed Susan	16 in x 16 in	10' x 10'
24	1	Black-eyed Susan	16 in x 16 in	10' x 10'
25	1	Black-eyed Susan	16 in x 16 in	10' x 10'
26	1	Black-eyed Susan	16 in x 16 in	10' x 10'
27	1	Black-eyed Susan	16 in x 16 in	10' x 10'
28	1	Black-eyed Susan	16 in x 16 in	10' x 10'
29	1	Black-eyed Susan	16 in x 16 in	10' x 10'
30	1	Black-eyed Susan	16 in x 16 in	10' x 10'
31	1	Black-eyed Susan	16 in x 16 in	10' x 10'
32	1	Black-eyed Susan	16 in x 16 in	10' x 10'
33	1	Black-eyed Susan	16 in x 16 in	10' x 10'
34	1	Black-eyed Susan	16 in x 16 in	10' x 10'
35	1	Black-eyed Susan	16 in x 16 in	10' x 10'
36	1	Black-eyed Susan	16 in x 16 in	10' x 10'
37	1	Black-eyed Susan	16 in x 16 in	10' x 10'
38	1	Black-eyed Susan	16 in x 16 in	10' x 10'
39	1	Black-eyed Susan	16 in x 16 in	10' x 10'
40	1	Black-eyed Susan	16 in x 16 in	10' x 10'
41	1	Black-eyed Susan	16 in x 16 in	10' x 10'
42	1	Black-eyed Susan	16 in x 16 in	10' x 10'
43	1	Black-eyed Susan	16 in x 16 in	10' x 10'
44	1	Black-eyed Susan	16 in x 16 in	10' x 10'
45	1	Black-eyed Susan	16 in x 16 in	10' x 10'
46	1	Black-eyed Susan	16 in x 16 in	10' x 10'
47	1	Black-eyed Susan	16 in x 16 in	10' x 10'
48	1	Black-eyed Susan	16 in x 16 in	10' x 10'
49	1	Black-eyed Susan	16 in x 16 in	10' x 10'
50	1	Black-eyed Susan	16 in x 16 in	10' x 10'
51	1	Black-eyed Susan	16 in x 16 in	10' x 10'
52	1	Black-eyed Susan	16 in x 16 in	10' x 10'
53	1	Black-eyed Susan	16 in x 16 in	10' x 10'
54	1	Black-eyed Susan	16 in x 16 in	10' x 10'
55	1	Black-eyed Susan	16 in x 16 in	10' x 10'
56	1	Black-eyed Susan	16 in x 16 in	10' x 10'
57	1	Black-eyed Susan	16 in x 16 in	10' x 10'
58	1	Black-eyed Susan	16 in x 16 in	10' x 10'
59	1	Black-eyed Susan	16 in x 16 in	10' x 10'
60	1	Black-eyed Susan	16 in x 16 in	10' x 10'
61	1	Black-eyed Susan	16 in x 16 in	10' x 10'
62	1	Black-eyed Susan	16 in x 16 in	10' x 10'
63	1	Black-eyed Susan	16 in x 16 in	10' x 10'
64	1	Black-eyed Susan	16 in x 16 in	10' x 10'
65	1	Black-eyed Susan	16 in x 16 in	10' x 10'
66	1	Black-eyed Susan	16 in x 16 in	10' x 10'
67	1	Black-eyed Susan	16 in x 16 in	10' x 10'
68	1	Black-eyed Susan	16 in x 16 in	10' x 10'
69	1	Black-eyed Susan	16 in x 16 in	10' x 10'
70	1	Black-eyed Susan	16 in x 16 in	10' x 10'
71	1	Black-eyed Susan	16 in x 16 in	10' x 10'
72	1	Black-eyed Susan	16 in x 16 in	10' x 10'
73	1	Black-eyed Susan	16 in x 16 in	10' x 10'
74	1	Black-eyed Susan	16 in x 16 in	10' x 10'
75	1	Black-eyed Susan	16 in x 16 in	10' x 10'
76	1	Black-eyed Susan	16 in x 16 in	10' x 10'
77	1	Black-eyed Susan	16 in x 16 in	10' x 10'
78	1	Black-eyed Susan	16 in x 16 in	10' x 10'
79	1	Black-eyed Susan	16 in x 16 in	10' x 10'
80	1	Black-eyed Susan	16 in x 16 in	10' x 10'
81	1	Black-eyed Susan	16 in x 16 in	10' x 10'
82	1	Black-eyed Susan	16 in x 16 in	10' x 10'
83	1	Black-eyed Susan	16 in x 16 in	10' x 10'
84	1	Black-eyed Susan	16 in x 16 in	10' x 10'
85	1	Black-eyed Susan	16 in x 16 in	10' x 10'
86	1	Black-eyed Susan	16 in x 16 in	10' x 10'
87	1	Black-eyed Susan	16 in x 16 in	10' x 10'
88	1	Black-eyed Susan	16 in x 16 in	10' x 10'
89	1	Black-eyed Susan	16 in x 16 in	10' x 10'
90	1	Black-eyed Susan	16 in x 16 in	10' x 10'
91	1	Black-eyed Susan	16 in x 16 in	10' x 10'
92	1	Black-eyed Susan	16 in x 16 in	10' x 10'
93	1	Black-eyed Susan	16 in x 16 in	10' x 10'
94	1	Black-eyed Susan	16 in x 16 in	10' x 10'
95	1	Black-eyed Susan	16 in x 16 in	10' x 10'
96	1	Black-eyed Susan	16 in x 16 in	10' x 10'
97	1	Black-eyed Susan	16 in x 16 in	10' x 10'
98	1	Black-eyed Susan	16 in x 16 in	10' x 10'
99	1	Black-eyed Susan	16 in x 16 in	10' x 10'
100	1	Black-eyed Susan	16 in x 16 in	10' x 10'

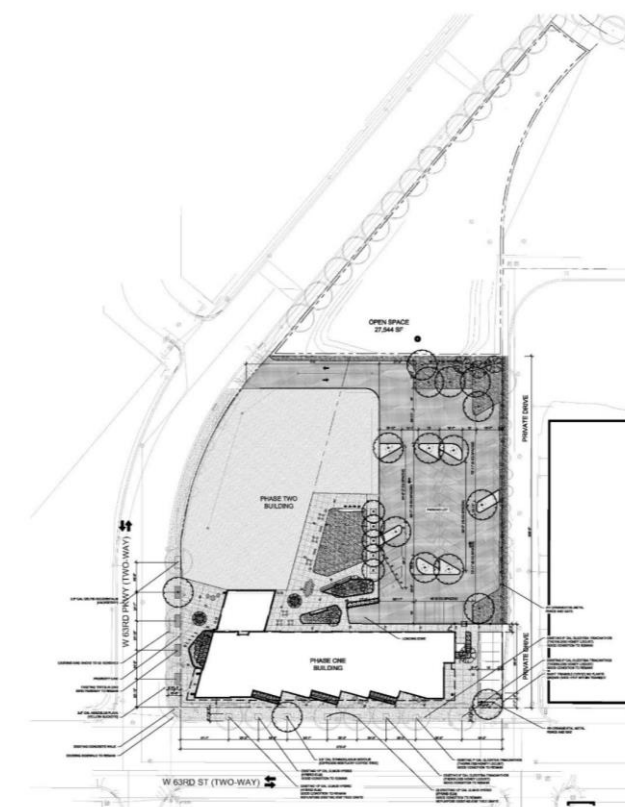

**LEGEND**

	PROPERTY LINE
	PRODUCT LINE (SEE EXHIBIT F FOR CLARITY)
	PROJECTING CONCRETE FINISH
	ASPHALT PAVING
	SELF-OPEN TREE PIT WITH OCCUPIED GRATES
	RAISED CONCRETE CURB
	EXPANSION JOINT
	CONTROL JOINT
	EXISTING TREE TO REMAIN
	SHADE TREE
	ORNAMENTAL TREE
	SHRUB
	GROUNDCOVER/PERENNIALS
	SOIL
	HYDRATED TURF
	EXISTING CHAIN LINK FENCE
	4FT CHAIN LINK FENCE AND GATE
	4FT ORNAMENTAL FENCE AND GATE
	OVERHEAD STORAGE LIGHTING AND POST
	BUILT-IN GRILL STATION
	TOWBAR SEATING
	TABLES AND CHAIRS
	PEBBLE SEATING
	FIRE TREE GRATE
	BENCH
	TREE PLANTER
	SIX TABLE AND STOOL
	FARM TABLE

1 OVERALL SITE PLAN  
1/12/22

1 SITE ENLARGEMENT PLAN  
1"=40'-0"

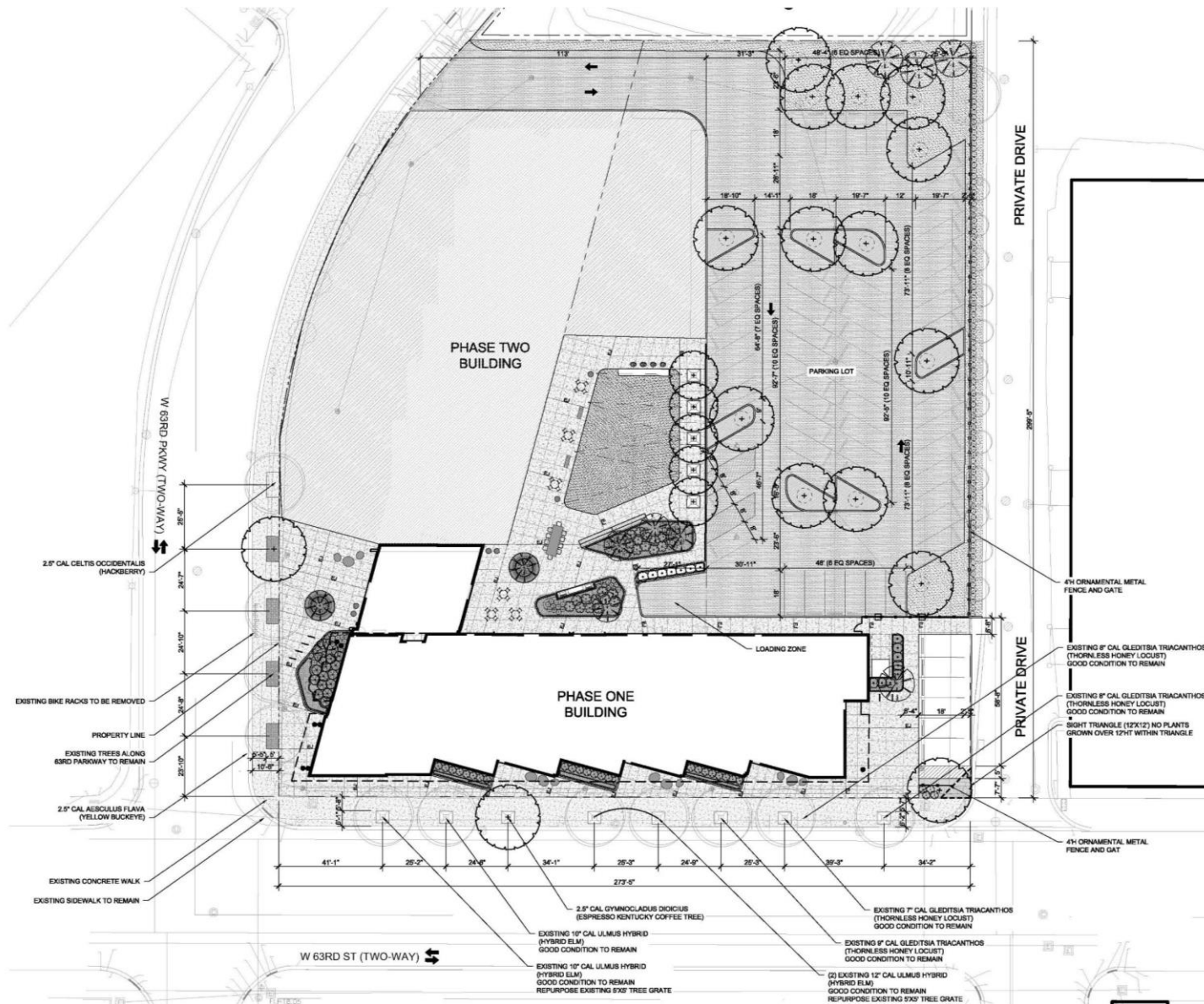

LEGEND

- PROPERTY LINE
- PROJECT LIMIT LINE (OFFSET 2' FOR CLARITY)
- PEDESTRIAN CONCRETE PAVING
- ASPHALT PAVING
- 5X10' OPEN TREE PIT WITH DECOMPOSED GRANITE
- RAISED CONCRETE CURB
- EXPANSION JOINT
- CONTROL JOINT
- EXISTING TREE TO REMAIN
- SHADE TREE
- ORNAMENTAL TREE
- SHRUBS
- GROUNDCOVER/PERENNIALS
- SOD
- HYDROSEED TURF
- EXISTING CHAIN LINK FENCE
- 4TH CHAIN LINK FENCE
- 4TH ORNAMENTAL FENCE AND GATE
- OVER-HEAD STRING LIGHTING AND POST
- BUILT-IN GRILL STATION
- TERRACED SEATING
- TABLES AND CHAIRS
- PEBBLE SEATING
- 5X5' TREE GRATE
- BENCH
- TREE PLANTER
- BAR TABLE AND STOOL
- FARM TABLE

LANDSCAPE SITE PLAN – PHASE I

The project is compliant with the City of Chicago Landscape Ordinance per the review and approval provided by Ron Daye on June 27, 2022.

TRAFFICWAY TREE P. 407 80-811.8	CODE	QTY	SCIENTIFIC NAME	COMMON NAME	MOOD	TEXT	REMARKS
20' x 20'	1	1	American Elm	White Barked	SHD	10'	shading tree
20' x 20'	1	1	Green Sycamore	Sycamore	SHD	10'	shading tree
20' x 20'	1	1	Strombosia alba	European Hornbeam	SHD	10'	shading tree

MINIMUM VEGETATION USE CALCULATION	20' x 20' SF
16 SPACE REMAINS FOR NON-ACCESSIBLE SPACES	20' x 20' = 400 SF
TOTAL VEGETATION USE AREA	7,396 ± 21,881 = 1,488 SF
REQUIRED INTERNAL LANDSCAPED AREA	5,908 SF
ACTUAL LANDSCAPED AREA	5,949 ± 13
REQUIRED INTERNAL TREE PLANTING	13
ACTUAL TREE PLANTING	13

**LEGEND**

- PROPERTY LINE
- PROJECT LIMIT LINE (DIFFERENT FOR CLARITY)
- EXISTING CONCRETE PAVED
- ASPHALT PAVING
- EXIST' OPEN TREE PIT WITH DECOMPOSED GRANITE
- PAVED CONCRETE CURB
- EXPANSION JOINT
- CONTROL JOINT
- EXISTING TREE TO REMAIN
- SHADE TREE
- ORNAMENTAL TREE
- SHRUBS
- GROUND COVER PERENNIALS
- SOIL
- HYDRICERT TURF
- EXISTING CHAIN LINK FENCE
- 4FT CHAIN LINK FENCE
- 4FT CHAIN LINK FENCE AND GATE
- 4FT ORNAMENTAL FENCE AND GATE
- OVERHEAD STRINGS LIGHTING AND POST
- BUILT-IN GRILL STATION
- TERRACED SEATING
- TABLES AND CHAIRS
- PIECES SEATING
- EXIT TREE GRATE
- BENCH
- TREE PLANTER
- BAR TABLE AND STOOL
- PAN TABLE

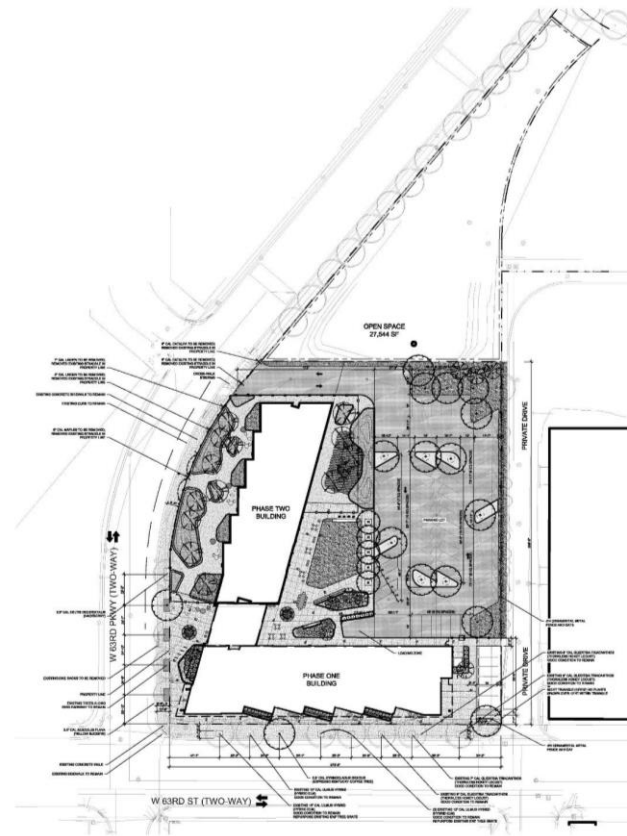

1 OVERALL SITE PLAN  
1" = 10'-0"

1 SITE ENLARGEMENT PLAN  
1"=40'-0"

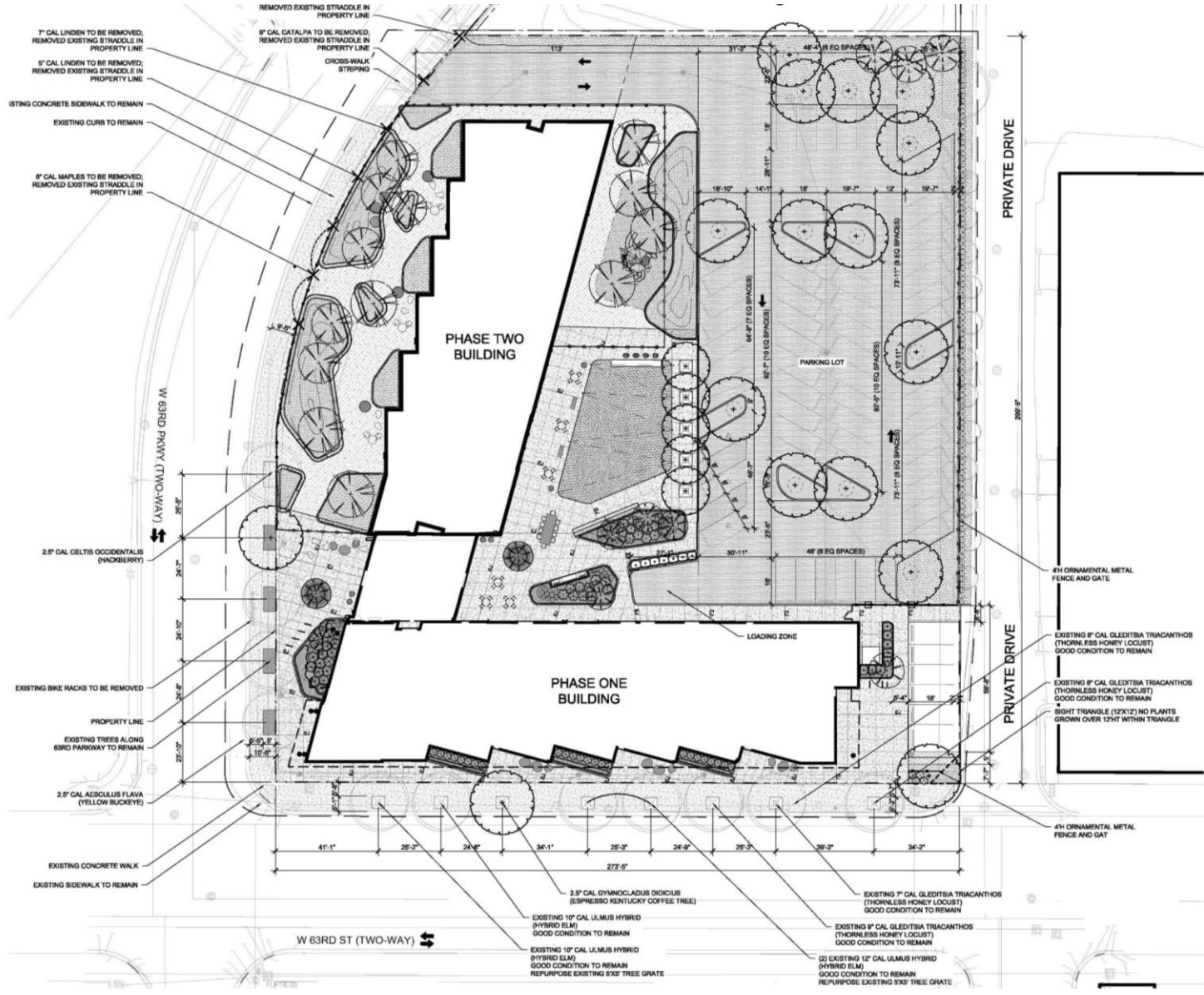

LEGEND

- PROPERTY LINE
- PROJECT LIMIT LINE (OFFSET 2' FOR CLARITY)
- PEDESTRIAN CONCRETE PAVING
- ASPHALT PAVING
- 6'X12' OPEN TREE PIT WITH DECOMPOSED GRANITE
- RAISED CONCRETE CURB
- EXPANSION JOINT
- CONTROL JOINT
- EXISTING TREE TO REMAIN
- SHADE TREE
- ORNAMENTAL TREE
- SHRUBS
- GROUNDCOVER/PERENNIALS
- SOB
- HYDRASEED TURF
- EXISTING CHAIN LINK FENCE
- 4" CHAIN LINK FENCE
- 4" ORNAMENTAL FENCE AND GATE
- OVERHEAD STRING LIGHTING AND POST
- BUILT-IN GRILL STATION
- TERRACED SEATING
- TABLES AND CHAIRS
- PEBBLE SEATING
- 5'X5' TREE GRATE
- BENCH
- TREE PLANTER
- BAR TABLE AND STOOL
- FARM TABLE

LANDSCAPE SITE PLAN – PHASE II

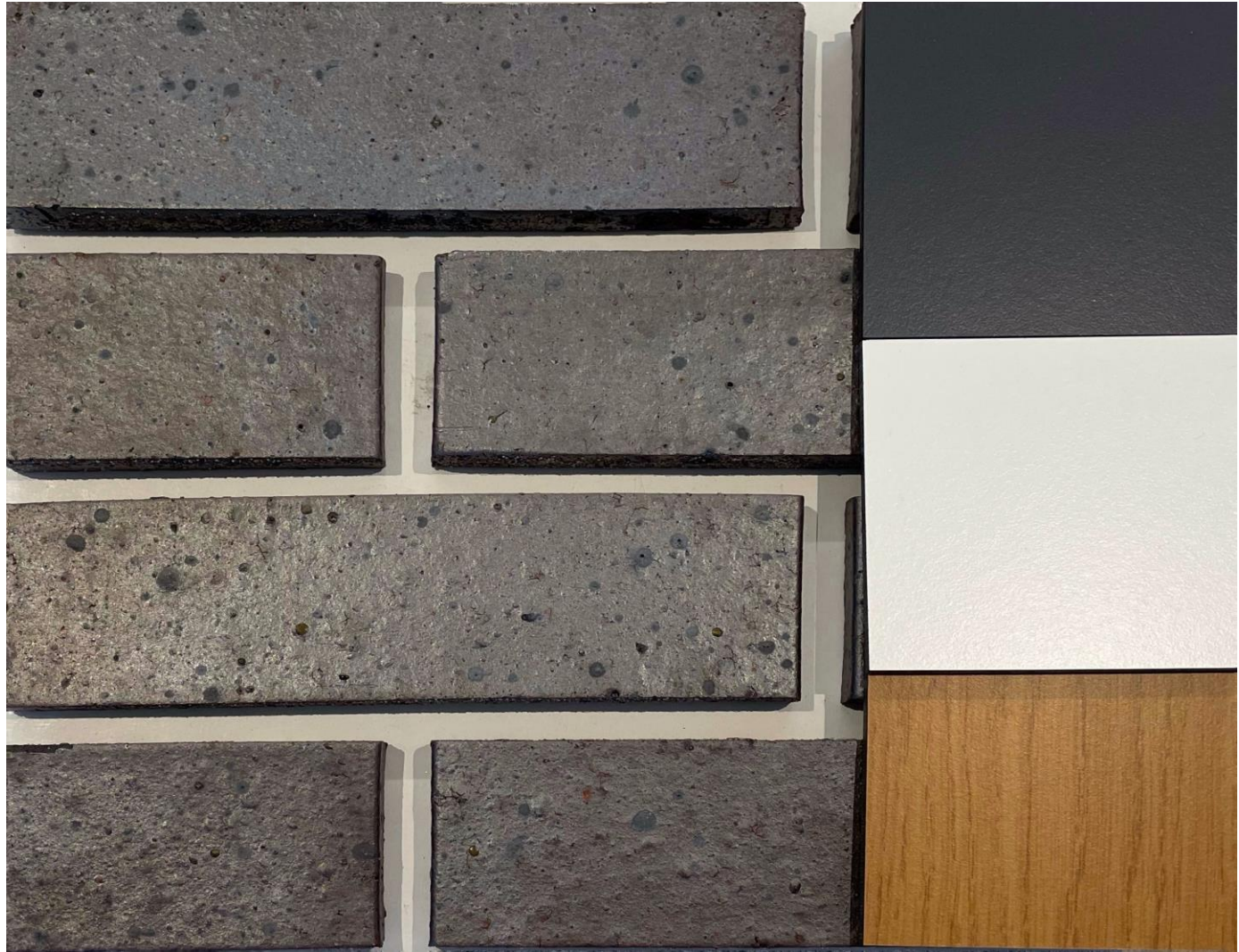







Compliance Paths	Starting Points	Number of Optional Points Required New Construction/Substantial Rehab/Moderate Rehab	Health	Energy						Stormwater						Landscapes					
			1.1 Achieve WELL Building Standard	Choose one					Choose one		Choose one			3.4 Sump Pump Capture and Reuse	3.5 100-year detention for lot-to-lot buildings	3.6 100-year detention for bypass	4.1 Working Landscapes	4.2 Natural Landscapes	4.3 Tree Planting	4.4 Achieve Sustainable Sites Certification	
				2.1 Designed to earn the Energy Star	2.2 Exceed Energy Code (5%)	2.3 Exceed Energy Code (10%)	2.4 Exceed Energy Code (25%)	2.5 Exceed Energy Code (40%)	2.6 Online Renewable Energy (3%)	2.7 Onsite Renewable Energy (5%)	3.1 Exceed Stormwater Ordinance by 25%	3.2 Exceed Stormwater Ordinance by 50%	3.3 100% Stormwater Infiltration								
<b>Options Without Certification</b>																					
All Options Available	0	100/50/25	40	30	20	30	40	50	10	20	10	20	40	5	5	5	5	5	5	5	20
<b>Options With Certification</b>																					
LEED Platinum	95	5/0/0	40	NA	NA	NA	NA	NA	NA	NA	10	20	40	5	5	5	NA	NA	NA	NA	20
LEED Gold	90	10/0/0	40	NA	NA	NA	NA	50	10	20	10	20	40	5	5	5	5	NA	NA	5	20
LEED Silver	80	20/0/0	40	NA	NA	NA	NA	40	50	10	20	10	20	40	5	5	5	5	5	5	20
Green Globes 4-Globes	90	10/0/0	40	NA	NA	NA	NA	50	10	20	10	20	40	5	5	5	5	NA	NA	5	20
Green Globes 3-Globes	80	20/0/0	40	NA	NA	NA	40	50	10	20	10	20	40	5	5	5	5	NA	NA	5	20
Green Globes 2-Globes	70	30/0/0	40	NA	NA	NA	40	50	10	20	10	20	40	5	5	5	5	5	5	5	20
Living Building Challenge	100	0/0/0	40	NA	NA	NA	NA	NA	NA	NA	10	20	40	5	5	5	NA	NA	NA	NA	20
Living Building Challenge Petal	90	10/0/0	40	NA	20	30	40	50	NA	NA	10	20	40	5	5	5	5	NA	NA	5	20
Enterprise Green Communities*	80	20/0/0	40	NA	NA	NA	NA	NA	10	20	10	20	40	5	5	5	5	5	5	5	20
PassiveHouse	70	30/0/0	40	NA	NA	NA	NA	NA	10	20	10	20	40	5	5	5	5	5	5	5	20

\*Only available to affordable housing projects funded by DPD's Housing Bureau

Planned Development Projects (PD) - New Construction	100 points required
TIF Funded Development Projects (TIF) - New Construction*	100 points required
DPD Housing, Multi-family (>5 units) projects (DPD-H MF) - New Construction	100 points required
PD, TIF, DPD-H MF and Class L - Renovation Projects*	
Moderate Renovation Projects	25 points required
Substantial Renovation Projects	50 points required

\*does not apply to TIF assistance of less than \$1M (including but not limited to TIF-NIP, TIF Purchase Rehab, Streamlined TIF and SBIF programs)

Moderate Renovation Projects - Projects including partial or minor upgrades to building systems and minor repairs to the exterior envelope  
Substantial Renovation Projects - Projects including new and/or upgraded building systems and extensive repairs to the exterior envelope

	Points Assured
	Points Under Consideration (Optional)
	Points not pursued

	Green Roofs		Water		Transportation								Work Force	Wildlife	
	Choose one		Choose one											Choose one	
	5.1 Green Roof 50-100%	5.2 Green Roof 100%	6.1 Indoor Water Use Reduction (25%)	6.2 Indoor Water Use Reduction (40%)	7.1 Proximity to Transit Service	7.2 Bikeshare Sponsorship	7.3 Bike Parking Residential	7.4 Bike Parking Commercial and Industrial	7.5 EV Charging Stations	7.6 EV Charger Readiness	7.7 CTA Digital Displays	8.1 80% Waste Diversion	8.2 Workforce Development	9.1 Bird Protection (Basic)	9.2 Bird Protection (Enhanced)
<b>Compliance Paths</b>															
<b>Options Without Certification</b>															
All Options Available	10	20	10	20	5	5	5	5	10	5	5	10	10	5	10
<b>Options With Certification</b>															
LEED Platinum	10	20	NA	NA	NA	5	NA	NA	NA	5	5	NA	10	5	10
LEED Gold	10	20	NA	NA	NA	5	NA	NA	10	5	5	10	10	5	10
LEED Silver	10	20	NA	20	NA	5	NA	NA	10	5	5	10	10	5	10
Green Globes 4-Globes	10	20	NA	NA	NA	5	NA	NA	10	5	5	10	10	5	10
Green Globes 3-Globes	10	20	NA	NA	NA	5	NA	NA	10	5	5	10	10	5	10
Green Globes 2-Globes	10	20	NA	20	NA	5	NA	NA	10	5	5	10	10	5	10
Living Building Challenge	NA	NA	NA	NA	NA	NA	NA	NA	10	5	NA	NA	10	5	10
Living Building Challenge Petal	10	20	10	20	NA	5	NA	NA	10	5	5	10	10	5	10
Enterprise Green Communities*	10	20	10	20	5	5	NA	NA	10	5	5	10	10	5	10
PassiveHouse	10	20	10	20	5	5	5	5	10	5	5	10	10	5	10

**115** Points Assured

**The project is fully compliant with the City of Chicago Stormwater Management Ordinance and is utilizing storage volume provided in an underground vault that was installed with the original Halsted Parkways development in 2014.**

### Job Creation

- The development of Thrive Englewood is expected to create approximately 100 construction jobs per phase, with outreach made to Englewood residents for these positions
- Thrive Englewood will also create 8 permanent property management jobs including Community Manager, Maintenance Supervisor and part-time Security Guard
- Retail space is expected to generate between 3 and 5 full-time and part time positions



### Participation Goals

- Thrive Englewood will exceed the City's 26% Minority Business Enterprise (MBE) and 6% Women Business Enterprise (WBE) requirements
- The Project will be bid to a minimum of three general contractors per DOH requirements, all of which are expected to be MBE or part of a joint venture with an MBE partner
- DL3 Realty Advisors is a minority-owned business and will develop Thrive Englewood

### Community Benefits

- Transit Oriented Development
- Retail services along 63rd Street
- Enhanced streetscaping

**Project Budget:** 31 million (Phase I)  
25 million (Phase II)

# DPD Recommendations



The Department of Planning and Development has reviewed the project materials submitted by the Applicant and compared this proposal to existing development in the community. The area around this project consists of a mix of commercial zoning districts, retail uses and institutional uses and is accessible from public transit; and the project represents an opportunity to construct a compatible residential-business mixed-use project within the Englewood Mall Area Tax Increment Financing District in the Englewood Community Area.

Based on that analysis, the Department of Planning and Development has concluded that this proposal is appropriate for this site and supports this development for the following reasons:

1. The proposed rezoning of the subject property is appropriate under Chapter 17-13 of the Zoning Ordinance. Specifically, the proposed planned development zoning classification and or the project is: 1) appropriate because of growth and development trends (17-13-0308-B); 2) compatible with the character of the surrounding area in terms of uses, density and building scale (17-13-0308-C); 3) compatible with surrounding zoning districts (17-13-0308-D)
2. The project meets the purpose and criteria set forth in Chapter 17-8 of the Zoning Ordinance and its adoption would not have any adverse impact on the public's health, safety or welfare. Specifically, this project meets the following provisions of Chapter 17-8:
  - a. The project is in strict compliance with the underlying FAR standards of the C1-3 zoning designation and is in substantial compliance with the other development control standards of the C1-3 zoning designation (17-8-901);
  - b. The project is consistent with the Englewood Mall Area Tax Increment Financing District Plan, including the proposed use of the subject site (per 17-8-0903);
  - c. All sides and areas of the building that are visible to the public are treated with materials, finishes and architectural details that are of high-quality and appropriate for use on primary street-facing façade (per 17-8-0907-B3), as evidenced through the material callouts in this report and on the elevations;
  - d. Provides where appropriate, substantial landscaping of the open areas on the building and site (per 17-8-0909-A2) as demonstrated by the project's parking lot, parkway and building setback, area landscaping and trees.
3. The proposed planned development promotes economically beneficial development patterns that are compatible with the character of existing neighborhood (per 17-8-0103), as evidenced by the design of the project, and the fact that the proposed design and the proposed uses are in context with the character of the adjacent properties and will meet the needs of the immediate community.
4. Promotes transit, pedestrian and bicycle use, ensures accessibility for persons with disabilities and minimizes conflicts with existing traffic patterns in the vicinity (per 17-8-0904-A- 1,2, 3 & 4), as evidenced by the site's proximity to public transit in the form of CTA bus lines, the site is also 945 feet from the Halsted Station situated along the CTA Green Line; the accessibility accommodations made on-site for the building users; pedestrian and bicycle ingress and egress options provided to the building users, and lastly ensuring that the design of the site works within the confines of the current existing traffic patterns at the site and creates little or no adverse impact to those patterns.

The project meets the purpose and criteria set forth in the Chicago Zoning Ordinance and its adoption would not have any adverse impact on the public's health, safety or welfare.

Based on the foregoing, it is the recommendation of the Department of Planning and Development that this application for a planned development be approved and that the recommendation to the City Council Committee on Zoning, Landmarks and Building Standards be "Passage Recommended," as amended.