



STREETSCAPE GUIDELINES

for the City of Chicago Streetscape
and Urban Design Program



City of Chicago
Mayor Richard M. Daley



Chicago Department of Transportation
Bureau of Bridges and Transit
Miguel d'Escoto, Commissioner

Prepared under the direction of:
Janet L. Attarian, A.I.A.
Project Director
Streetscape and Urban Design Program

November 2003



STREETSCAPE GUIDELINES

for the City of Chicago Streetscape
and Urban Design Program

City of Chicago
Mayor Richard M. Daley

Chicago Department of Transportation
Bureau of Bridges and Transit
Commissioner, Miguel d'Escoto

Prepared under the direction of:
Janet L. Attarian, A.I.A.
Project Director,
Streetscape and Urban Design Program

November 2003



Dear Chicagoans:

We are proud to present this booklet entitled “Guidelines for the City of Chicago Streetscape and Urban Design Program.” These guidelines have been prepared for community leaders, public officials, design consultants, and private developers throughout Chicago to assist them in making informed decisions in the design of city streets. The Guidelines address fundamental quality of life issues within a streetscape, such as safety, accessibility, and neighborhood identity. In addition, the Guidelines provide a framework that encourages the development of Chicago’s commercial streets as vital places for residents, tourists, shoppers, and commuters to live, work, and play.

The objective of these Streetscape Guidelines is to encourage the enhancement and revitalization of commercial areas in Chicago. These guidelines form the underpinnings of the community-based design process employed by the city for streetscape projects. By utilizing these Guidelines, parties involved in this design process can now be better informed as to the exact nature and composition of city streetscapes.

We would like to thank the many citizens, agency personnel, community groups, and public officials who have contributed both historically and currently to the content of these Guidelines. The Guidelines represent an exciting opportunity to enhance Chicago’s current streetscapes and to encourage the standardization and compliance of future projects.

Sincerely,

A handwritten signature in black ink, appearing to read "Richard M. Daley". The signature is stylized with a large initial "R" and "M".

Richard M. Daley

Mayor
City of Chicago



TABLE OF CONTENTS

- 1. STREETScape GUIDELINES: A TOOL FOR COMMUNITY INVOLVEMENT**
 - Streetscapes and the Private Sector 1-2
 - Streetscape and Urban Design Program Mission 1-3
 - The Streetscape Implementation Process 1-4
 - Design Phase 1-5
 - Special Considerations During Design 1-8
 - Construction Phase 1-9
 - Construction Phasing and Staging 1-10
 - Post Construction and Beyond 1-11

- 2. ORGANIZING A STREETScape**
 - Components of a Streetscape 2-1
 - Streetscape Zones 2-2
 - Organizing the Streetscape 2-4
 - Streetscape Elements 2-5
 - The Element Line 2-6
 - Balance in the Streetscape: The Module 2-7
 - Breaches in the Module 2-8
 - Human Psychology in the Streetscape 2-9
 - Shy Zones 2-10
 - Maintenance and Community Commitment 2-11

- 3. FUNCTIONAL REQUIREMENTS**
 - Sidewalk Classifications 3-1
 - Sidewalks Less than 9' Wide 3-2
 - Sidewalks 9'-12' Wide 3-3
 - Sidewalks Greater than 12' Wide 3-4
 - Parking 3-5
 - Corners 3-7



■ Curb Extensions	3-8
■ Crosswalks	3-9
■ Mid-Block Crossings	3-10
■ Driveways and Alleyways	3-11
■ Loading Zones	3-12
■ Vaulted Sidewalks	3-13
■ Bus Stops	3-14
■ Bus Pads	3-14
■ Medians	3-15
■ Bike Lanes	3-16
■ Viaducts	3-18
■ Special Security Issues	3-18
4. STREETScape ELEMENTS	
■ Lighting	4-2
■ Vehicular Lighting	4-3
■ Pedestrian Lighting	4-4
■ Viaduct Lighting	4-6
■ Lighting Enhancements	4-7
■ Trees and Plantings	4-8
■ The Chicago Landscape Ordinance	4-8
■ Plant Material	4-9
■ Use and Effect	
■ Plant Height and Sight Triangles	
■ Maintenance	
■ Salt Tolerance	
■ Irrigation	
■ Color	
■ Planters	4-12
■ Flush Planters	
■ Curbed Planters	
■ Free-Standing Planters	
■ Hanging Baskets	
■ Landscaping and Utilities	
■ Railings	4-14



TABLE OF CONTENTS

- Tree Grates 4-16
 - Cast Iron Tree Grates
 - Plastic Tree Grates
- Sidewalk Pavement 4-17
 - Monolithic Sidewalks 4-17
 - Scored Concrete
 - Window Panes
 - Stamped Concrete
 - Concrete Detailing and Streetscape Elements
 - Unit Paver Sidewalks 4-20
 - Concrete Unit Pavers
 - Clay Unit Pavers
 - Special Finish Pavers
 - Unit Pavement Construction 4-23
 - Flexible Base System
 - Rigid Base System
- Roadway Pavement 4-24
 - Striping 4-24
 - Crosswalks 4-25
 - Stamped Asphalt 4-25
 - Curb and Gutter 4-26
 - Curb Ramps 4-26
- Street Furniture 4-28
 - Benches 4-28
 - Trash Receptacles 4-28
 - Bicycle Racks 4-29
 - Bollards 4-29
- Community Identifiers 4-30
 - Identifier Elements 4-31
 - Gateways and Area Markers
 - Kiosks
 - Banners and Pole Identifiers
 - Sidewalk Medallions
 - Public Art
 - Construction and Maintenance 4-35
 - Design Standards 4-35

■ Parking	4-36
■ Parking Meters	4-36
■ Pay Boxes for Street Parking	4-36
■ Diagonal Parking	4-37
■ Traffic Control Devices	4-38
■ Signage	4-38
5. COMBINING STREETScape ELEMENTS	
■ Steps to a Successful Project	5-1
■ Beautification and Livability	5-1
■ Right-of-Way Width	5-2
■ Budget and Maintenance	5-2
■ Streetscape Combinations	5-3
■ Sidewalks 9' Wide or Less	5-3
■ Concept A-1	
■ Concept A-2	
■ Concept A-3	
■ Streetscape Examples: Sidewalks Less than 9' Wide	
■ Sidewalks 9'-12' Wide	5-8
■ Concept B-1	
■ Concept B-2	
■ Concept B-3	
■ Streetscape Examples: Sidewalks 9'-12' Wide	
■ Sidewalks 12' Wide or Greater	5-13
■ Concept C-1	
■ Concept C-2	
■ Concept C-3	
■ Concept C-4	
■ Streetscape Examples: Sidewalks 12' Wide or Greater	
■ Conclusion	5-19
APPENDICES	



A. COMPLETED STREETSCAPES	A-1
B. COMMUNITY PARTICIPATION	B-1
■ Façade Rebate Program	B-2
■ Special Service Area Program	B-3
■ Community Maintenance Agreement	B-5
■ Streetscape Design Elements Maintenance and Management Responsibilities	B-7
C. LANDSCAPE RESOURCES	
■ The Landscape Ordinance	C-1
■ Urban-Tolerant Tree Species	C-1
■ Landscape Quarantine Zones	C-2
■ Protection of Trees	C-2



47th Street Streetscape (Source: Rendering by Bruce Bondy)

STREETSCAPE GUIDELINES: A TOOL FOR COMMUNITY INVOLVEMENT





Figure 1-1: Broadway Avenue



Figure 1-2: 53rd Street

**STREETScape GUIDELINES:
A TOOL FOR COMMUNITY INVOLVEMENT**

This guide demonstrates the City of Chicago’s many years of experience in designing and building streetscapes. It is intended to assist aldermen, communities, and developers in beautifying their commercial districts now and keeping them attractive well into the future. As streetscapes in urban environments are subject to heavy use and adverse environmental conditions, they require consistent maintenance to remain appealing. By establishing the guidelines in this booklet, the Chicago Department of Transportation (CDOT) seeks to standardize elements that are not only beautiful and functional, but also easy to repair and maintain whenever maintenance is required.

This guide provides the tools necessary to plan a successful streetscape and offers helpful information about the streetscape planning process, the major building blocks and standard elements that compose a streetscape, the special circumstances that should be considered, and a variety of streetscape design examples. It also includes the City of Chicago palette of standard streetscape elements.

These concepts and standards are guideposts for navigating the path from the initial desire for streetscape improvements to the successful realization of an actual, implemented streetscape project. This guide represents the best knowledge of the Streetscape and Urban Design Program to date. This knowledge will continue to develop and change as more streetscapes are implemented and as the Program continues to learn and grow.



Figure 1-3: Public/private partnership and a community commitment to maintenance enable this lush streetscape.

STREETSCAPES AND THE PRIVATE SECTOR

Under the City of Chicago Zoning and Landscape Ordinances, developers of new buildings and major rehabilitation projects are required to include improvements in the public way (usually the sidewalks immediately adjacent to the property being developed) as part of the project. This is a wonderful example of public/private cooperation that improves the livability and beauty of the City for everyone. The issue of maintenance, however, is no less important in these cases as it is when the City itself makes improvements in the public way.

While this guide does not attempt to outline the process developers use to obtain the various permits required for construction, many aspects of these guidelines may be helpful for developers. The chapters Organizing a Streetscape (Chapter 2), Functional Requirements (Chapter 3), and Streetscape Elements (Chapter 4) contain pertinent information about how developers should go about planning and constructing in the public way.

Although property owners are responsible for maintaining the public way adjacent to their property, after the developer is gone the City is often requested to participate in the long term repair and maintenance of the infrastructure installed in the public way. Trees die, tree grates break, or sidewalks deteriorate. In order for the City to participate in the long term maintenance of any of these items, it is important that the same standard elements used and maintained by the City are also used by developers and property owners.



Figure 1-4: Oak Street



Figure 1-5: Clark Street project side street treatment

STREETScape AND URBAN DESIGN PROGRAM MISSION

Chicago’s streets play an important role in the livability, vitality, and character of our neighborhoods and commercial areas. They form the grid that weaves the quilt of the City into a whole cloth. It is the design and rejuvenation of streets and transportation corridors, via infrastructure renovations and beautification, which lies at the heart of the Streetscape and Urban Design Program’s mission. The program strives to promote the economic and social development of neighborhood commercial areas through renovating and improving the quality of our streetscapes, thereby beautifying the City and creating a greener, more friendly environment in which citizens live, work, and play.

Another aspect of the Streetscape and Urban Design Program mission is to improve environmental quality. Trees and plantings, key elements in the streetscape, improve air quality by producing oxygen and removing carbon dioxide and particulate matter. For example, 13 mature trees remove the particulate matter generated by a car driven 12,000 miles a year. Trees and plantings also increase storm water retention and mitigate the “urban heat island effect.”

The Streetscape and Urban Design Program focuses on implementing streetscapes for commercial streets. Improvements for residential streets are handled through the City of Chicago’s Model Blocks Program or the 50/50 Program. Installation of trees or other plant material in these areas is handled by the Chicago Bureau of Forestry, the Green Streets Program, or other agencies.



Figure 1-6: Artist rendering of the 47th Street streetscape (Source: Rendering by Bruce Bondy)

THE STREETScape IMPLEMENTATION PROCESS

The successful planning and implementation of a streetscape project must follow a specific process to bring the vision into reality. Initially, aldermen bring projects to the attention of CDOT. In order to obtain funding through the Streetscape and Urban Design Program, projects must meet certain criteria:

- Fifty percent or more of the property surrounding the right-of-way must be an existing or planned commercial area.
- Aldermen, businesses, and the community must support the project.
- Existing lighting and other major infrastructure, such as roadways, sidewalks, curb and gutters, etc., must be sub-standard and in need of improvement.
- Cultural improvements, such as the installation of public art or historic markers, are being planned in the public way and require streetscape intervention.



Figure 1-7: Community participation is an important part of streetscape design and implementation

If the criteria are met, the streetscape process can begin. The process can be roughly broken into two phases, the design phase and the construction phase.

Design Phase

The project begins with designing the streetscape, which typically takes from eight to 12 months. The average length of a streetscape project is six 300-foot blocks. If a project is much longer than this it will be subdivided into phases to be constructed over consecutive years, as funding becomes available.

Step One: Initial Streetscape Design

- Define a preliminary scope for the streetscape work based on the *Streetscape Guidelines*.
- Establish an initial budget based on the scope of work.
- Secure a funding source for the project design fees.
- Retain the services of a design consultant.
- Hire a surveyor to prepare a topographic survey of the proposed project site.
- Review codes and standards, including lighting, parking, landscape, and various other considerations, that will impact the streetscape design.
- Develop streetscape design concepts.

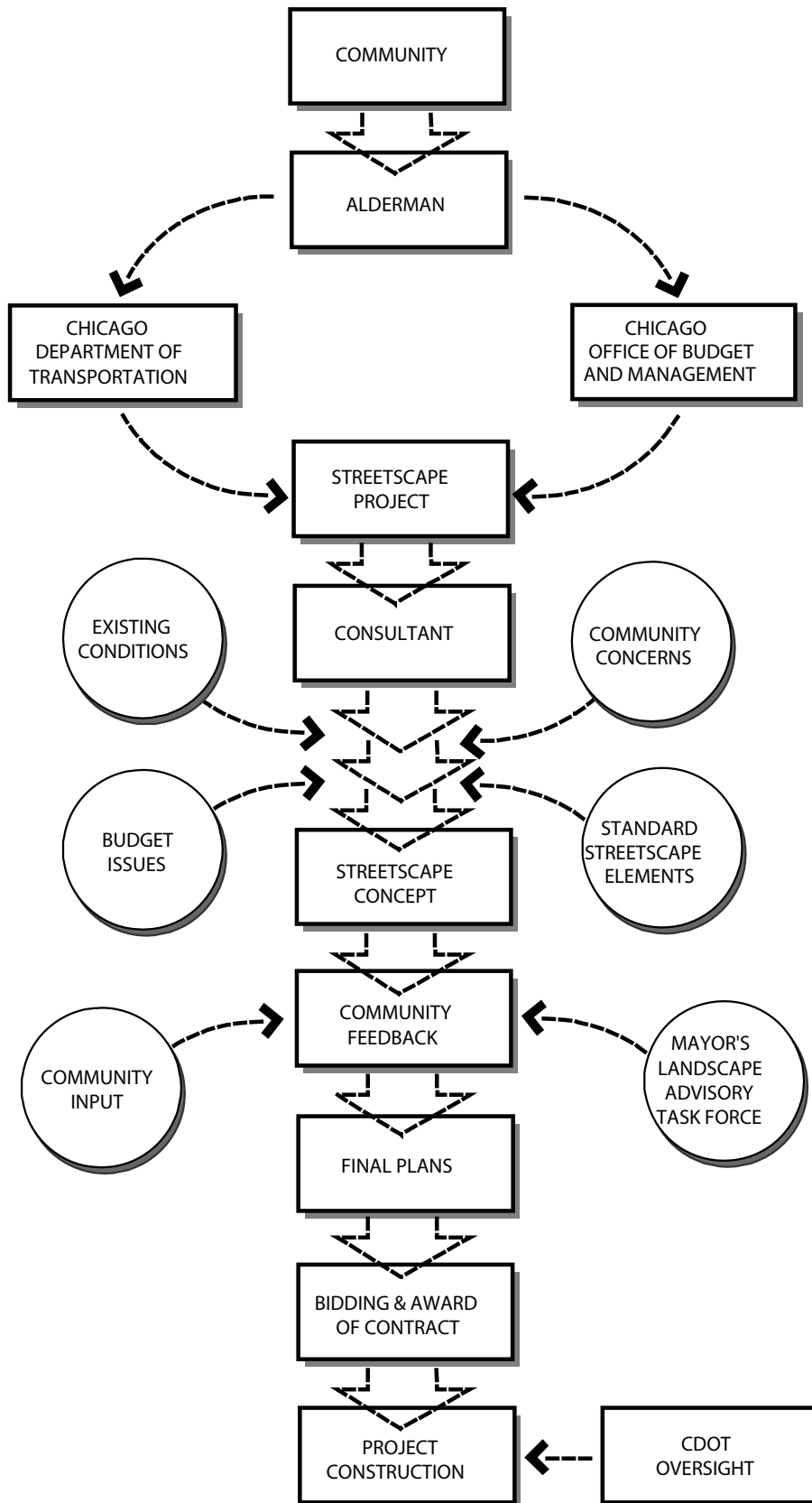

Figure 1-8: Streetscape project implementation process

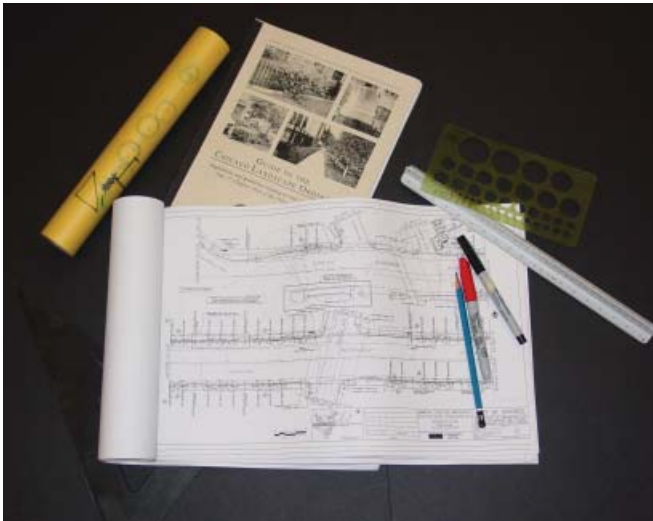

Figure 1-9: Final construction documents end the design phase of the project



Figure 1-10: Construction documents in progress

Step Two: Community Support

- CDOT presents design concepts to the aldermen and the community for review and comment. At this point, which occurs at about the 30 percent milestone in the project, CDOT and the community must determine the issues that are most important to the overall streetscape.
- Refine concepts based on input from aldermen and the community. Generate a final concept, based on consensus, that is consistent with the *Streetscape Guidelines* and budgetary constraints.
- CDOT presents the approved concept to the Mayor's Landscape Advisory Task Force for review and comment.

Step Three: Construction Documents

- Once a final concept is approved, develop specific details, drawings, and technical specifications in preparation for competitive bidding for the construction of the streetscape project.
- If necessary, schedule another community meeting to review the streetscape's final details.
- Present final streetscape plan to the Mayor's Landscape Advisory Task Force for final approval.
- Confirm that final cost estimates are within the approved construction budget.
- Complete final drawings and specifications.

Figure 1-8 illustrates the process for establishing a streetscape project and developing a final streetscape plan. At this point, even though the construction plans are complete, the project is still only an idea on paper. Although projects typically follow the traditional construction process, the Streetscape and Urban Design Program is experimenting with design/build project delivery where the construction documentation phase is rolled into the construction phase.



Figure 1-11: A community commitment to maintenance is an important aspect of incorporating large planters in a streetscape



Figure 1-12: Community members play a critical role in maintaining plantings

Special Considerations During Design

It is important to be aware of budgetary considerations right from the beginning of the streetscape process. The costs for designing and installing a streetscape vary depending on the width of the sidewalk zone, the length of the project, the extent of streetscape elements, and the level of customization being used for community identifiers and other special aspects of the streetscape. As a general rule of thumb, streetscapes cost approximately \$350,000 per 300-foot long block. However, costs can range between \$300,000-\$450,000 per block, depending on the scope of the streetscape and the length of the block. It is important to keep these costs in mind throughout the design of the project.

Maintenance concerns must also be addressed early in the streetscape design process. These issues often drive the type of amenities to be included since certain streetscape elements require a significant community commitment to ongoing maintenance. For example, the community is responsible for maintaining all plant material, except trees. This includes weeding, watering (if irrigation is not provided), plant replacement, and litter pickup. It is the policy of the Streetscape and Urban Design Program to provide these elements in the streetscape only if the community is willing to play an active and ongoing role in maintenance. Therefore, clarifying the community's level of commitment is a key component of the streetscape design process. The community must assess its ability to provide maintenance and assign individuals to be responsible for it. This information becomes a critical input to the design process as it will influence the amount and location of planters as well as plant material choices.



Figure 1-13: During streetscape construction, parking is removed from both sides of the street to allow for uninterrupted two-way traffic flow

Construction Phase

The construction phase brings the project from idea into reality. Construction milestones include:

- Identify and obtain funding for construction costs
- Advertise for competitive bids
- Recommend a contractor for award
- Award the construction contract
- Issue the notice to proceed to the contractor
- City holds a pre-construction meeting
- CDOT passes out flyers to property owners along the streetscape notifying them of the upcoming construction
- Begin construction
- Issue final punch list of construction items
- Closeout construction



Figure 1-14: Streetscape construction

The construction phase may take from four to 12 months, depending on the size and complexity of the project. In order to ensure that projects are completed on schedule and within budget, CDOT oversees day-to-day construction and makes all decisions with respect to material selection, staging, and schedule. CDOT encourages community input through weekly construction meetings where concerns may be aired.

Construction Phasing and Staging

Construction is usually performed in rolling phases. Work begins at one end of the job, on one side of the street, and proceeds to the opposite end of the project. It then flips to the other side of the street and moves back to the end it started from. Typically a contractor is given a three-block work zone from which construction cannot advance until the new sidewalk is installed. In this way, the job progresses in a controlled manner and keeps as much of the street intact for as long as possible.

Access to businesses and residents is maintained throughout the construction project. This is usually done by splitting the sidewalk in half. The section along the curb is removed and new curb and gutter and utilities are installed. When this is finished, the remaining half of the sidewalk is removed and the entire sidewalk is replaced within 48 hours, or less. This minimizes the impact to businesses and allows continuous access during construction. If the sidewalk is narrow, it cannot be split into two zones and a pedestrian lane is set up in the street, parallel to the curb line. This area is protected from traffic and has “bridges” over the work zone to the individual building addresses.

Two-way traffic is maintained throughout construction. Parking is removed from one or both sides of the street, depending on the width of the right-of-way, to maintain two-way traffic. Most projects do not require street closings or detours during construction.



Figure 1-15: Clark Street project side street treatment

Post Construction and Beyond

Once construction is complete, the project goes into maintenance mode. For maintenance to be successful it must be a joint effort between the community and the City. Not only does the community play a direct role in maintaining plantings, it keeps eyes and ears on the project and is typically the source of alerting various City agencies in charge of long term maintenance to problems in need of attention. (See Appendix B for a list of these agencies and their responsibilities.)

If planned and installed according to the standards described in this guide, the newly implemented streetscape should provide a functional and attractive community backdrop for years to come.



ORGANIZING A STREETScape





Figure 2-1: Devon Avenue

ORGANIZING A STREETScape

The first step in planning a streetscape project is to understand the component parts of the streetscape, including the physical space that makes up the streetscape improvement zone, as well as the variety of potential individual streetscape elements.

COMPONENTS OF A STREETScape

Each element of the street contributes to the streetscape and to the overall identity of the neighborhood. The street right-of-way is the term used to describe the publicly owned area between two property lines that are directly across the street from each other. This is the zone of the streetscape. It is the area where public and private interests combine to create the identity of a commercial district.



Figure 2-2: 53rd Street



Figure 2-3: Howard Street

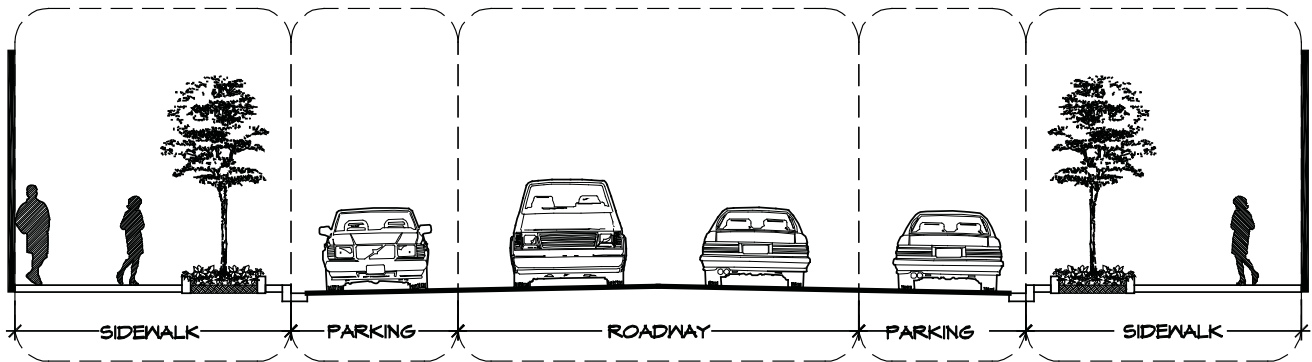

Figure 2-4: Streetscape zones



Figure 2-5: Halsted Street in the Greek Town neighborhood

Streetscape Zones

The streetscape may include a variety of elements, such as vehicle travel and parking lanes, bike lanes, sidewalks and carriage walks, street furniture, bus stops, utility poles, trees, accent plantings, and signage. All of these items occur in one of three major zones of the streetscape:

The **Sidewalk Zone** is the “front porch” of every business and residence. It is the place where people meet their neighbors, interact, or simply enjoy a stroll. It allows pedestrians access throughout the streetscape into residences and businesses. Pedestrians traverse this zone coming from their cars, accessing shops and residences, or simply walking through the commercial district.

The **Parking Zone** allows shoppers who are travelling by car to patronize a commercial district. It is also the location of loading zones for businesses as well as transit stops.

The **Roadway Zone**, or vehicular zone, generally allows for the movement of motor vehicles through a streetscape, although it may also provide for bicycle traffic with bike lanes adjacent to the parking zone. Underground utilities, although hidden from view, are often located in this zone.



Figure 2-6: Streetscape zones on Bryn Mawr Avenue

Although each of these zones is distinct, they often overlap and interact. For example, the simple act of crossing the street requires a pedestrian to traverse all three of these zones. Street lighting located in the sidewalk zone overlaps parking and roadway zones. Intersections often contain traffic control devices located in the sidewalk zone. Curb extensions, crosswalks, and universally accessible curb ramps help define pedestrian crossing areas in vehicular zones. Thus, the vehicular zone enters the sidewalk zone, just as the sidewalk zone enters the vehicular zone.



Figure 2-7: Grand Avenue

ORGANIZING THE STREETScape

Understanding the relationship and interaction of the activities within the three zones is vital to the successful organization of a streetscape. Each commercial district and intersection needs to be observed and analyzed to address the activity level in each zone as well as its overall character. There are many aspects of the public right-of-way to consider when designing a streetscape, including:

- Width of the sidewalk
- Bus stops
- Commercial and residential density
- Pedestrian traffic volume
- Parking requirements and restrictions
- Vehicular traffic intensity
- Bicycle lanes
- Overall right-of-way width
- Number of vehicular traffic lanes

These characteristics affect how a streetscape is designed and constructed as well as its ability to attract pedestrians and residents.



Figure 2-8: Streetscape lighting elements



Figure 2-9: A variety of streetscape elements on Devon Avenue



Figure 2-10: Streetscape elements on Oakley Street



Figure 2-11: Lights, banners, and sidewalk detailing

Streetscape Elements

A streetscape is defined by two major elements:

- Lighting
- Trees and other landscape plantings

Secondary elements add detail and texture. These include:

- Sidewalk Pavements
- Roadway Pavements
- Street furniture, including benches, waste receptacles, and bike racks
- Parking meters
- Community identifiers and kiosks (vertical elements)
- Public art
- Bus stops and shelters
- Traffic control devices

Chapter Four describes each of these elements in greater detail.



Figure 2-12: Streetscape elements decorated for the holidays on Lincoln Avenue

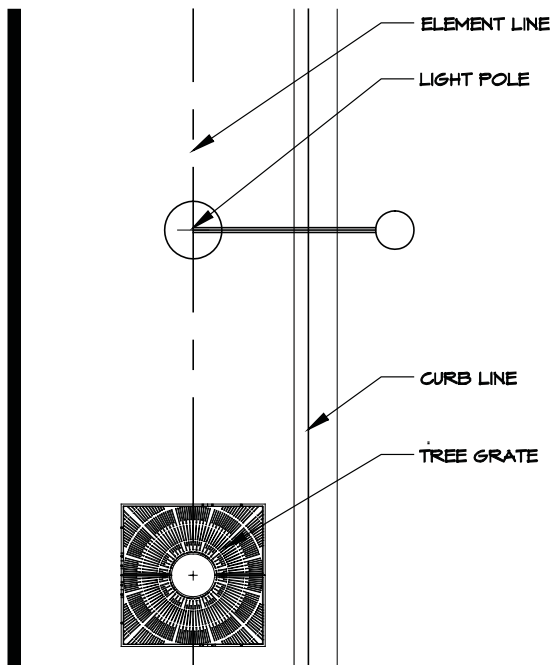

Figure 2-13: The element line with trees in grates

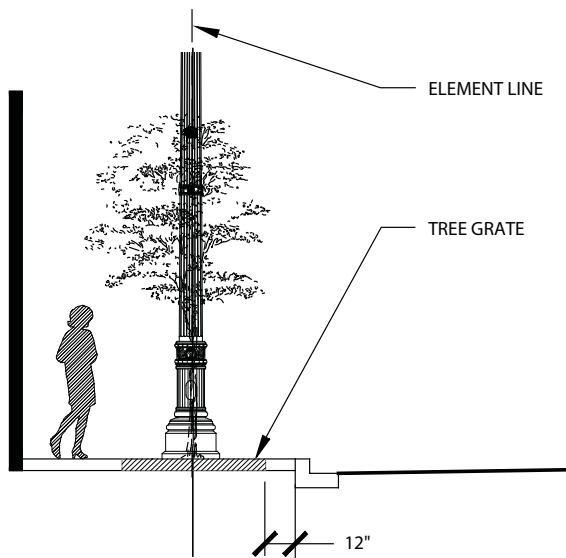

Figure 2-14: The element line with trees in grates

The Element Line

When various streetscape elements are repeated over a typical block, the streetscape creates a particular rhythm depending on the use, arrangement, and emphasis of different elements. For any given typical block, there are many potential options for arranging elements.

This string of elements is loosely arranged around an element line, an artificial line that generally runs parallel to the street curbing. This element line doesn't necessarily correspond to the centerlines of the individual elements.

Given the highly varied widths of the sidewalks in the City, there are some basic guidelines to follow.

Lighting: Set the center line of fixtures at least 36" from face of curb. Spacing between light poles should be a function of lighting levels and rhythm with other objects in the element line such as planters, trees, and parking meters. When these elements are linked together dimensionally, their arrangements can be logically laid out on the block.

Trees: Where space is limited, plant trees in tree grates, 4' x 6' or 5' x 5' in size. In narrow sidewalks, tree grates can be placed adjacent to the curb, which creates an element line 2'-3' from the face of the curb (the tree trunk is the element in this case). In wider sidewalks, the ideal tree grate installation has a band of sidewalk (typically 1'-3' wide, depending on the width of the sidewalk) between the curb and the tree grate. This creates an extra setback for the trees that minimizes conflicts with parked cars.



Figure 2-15: The repetition of trees in grates and streetlights along the block creates the “module”

Planters: Where space allows, trees may be planted in raised planters. Planters should be placed a minimum of 1’ from the back of the curb and have a minimum inside width of 4’. Curbs form the edge of the planters and should be 6”-8” wide. A low ornamental fence or railing may also be included.

See Chapter Four for a more detailed discussion of planters, tree grates, and lighting.

Balance in the Streetscape: The Module

The combination of all the elements used in the streetscape design creates the “module.” This term describes the arrangement of elements in relation to each other. A good streetscape design achieves a balance between all elements, with the location of each element being adjusted in relationship to the others until a harmonious design is achieved.

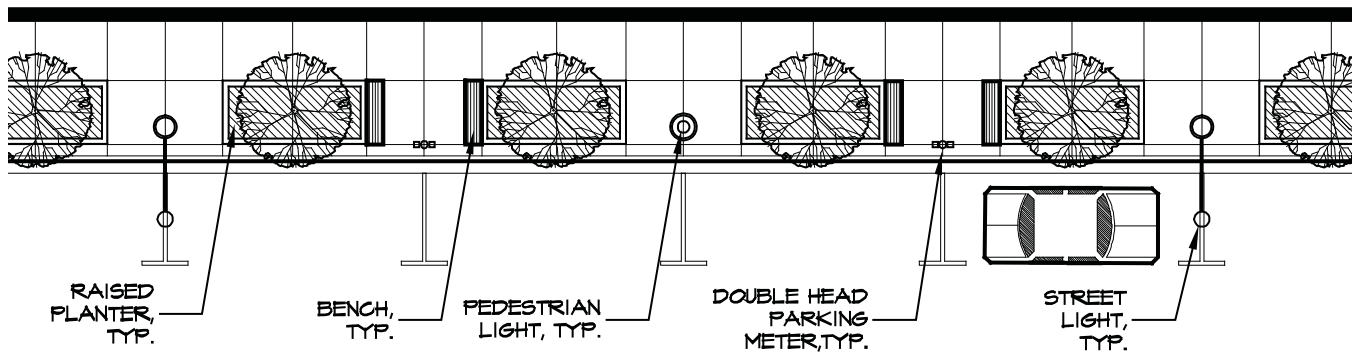
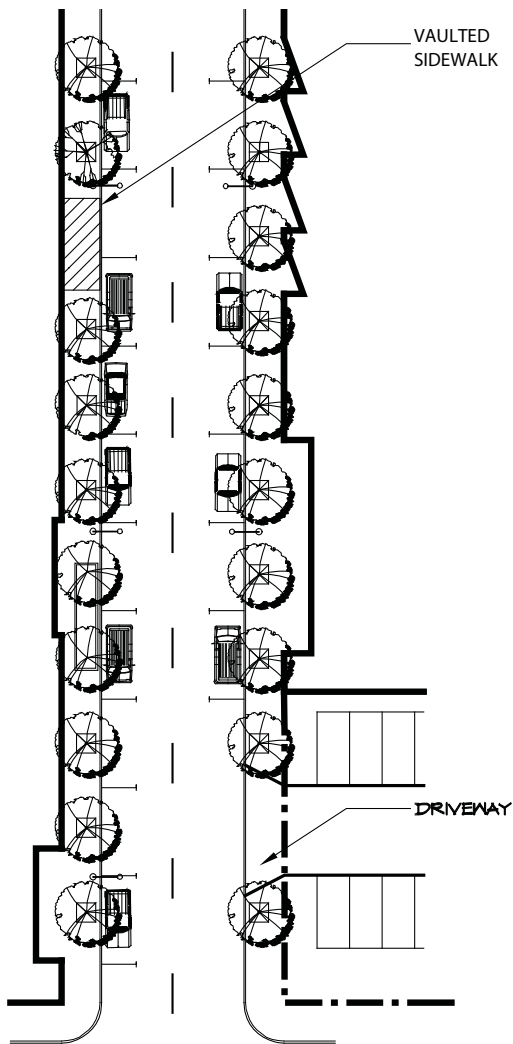

Figure 2-16: The combination of streetscape elements in relation to one another constitutes the module



Breaches in the Module

Once an element line is established, it must be fitted to the unique existing conditions of each block in the streetscape. Breaches in the element line can occur for many reasons, including:

- Driveways
- Vaulted sidewalks
- Existing utilities
- Existing trees
- Intersections
- Overhanging signs
- Significant building entrances
- Bus stops
- Adjacent public spaces

These existing conditions disrupt the element line and can be accommodated by shifting the entire module, shifting individual elements within the module, or eliminating individual elements.

Figure 2-17: Breaches in the element line occur when the desired module must be interrupted to accommodate existing conditions such as driveways, vaults, and existing trees



Figure 2-18: Existing driveways interrupt the module and must be accommodated

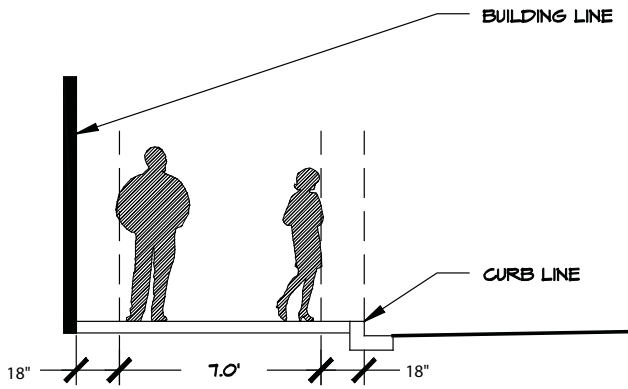

Figure 2-19: Pedestrian level of service A

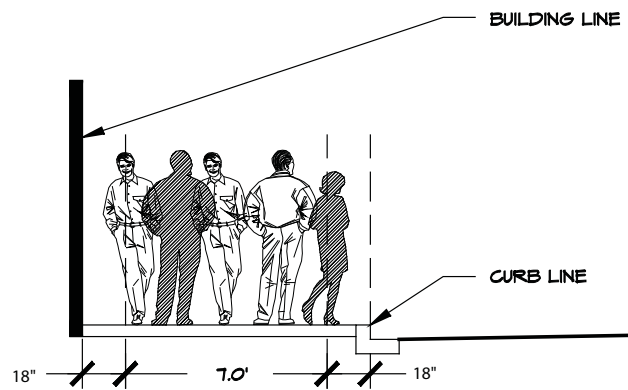

Figure 2-20: Pedestrian level of service B

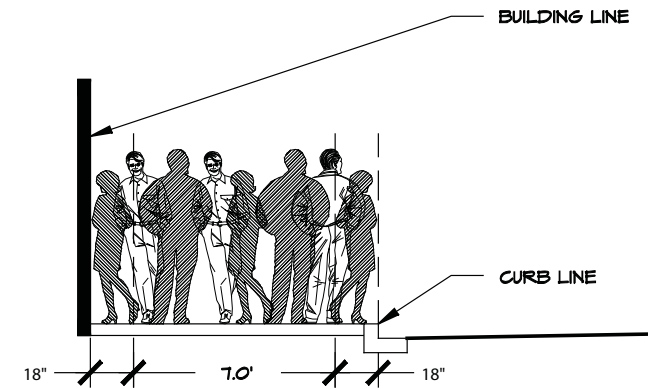

Figure 2-21: Pedestrian level of service C

HUMAN PSYCHOLOGY IN THE STREETScape

A successful streetscape must accommodate another, unseen yet critical, element — the way people react to and use space. In the landmark book published in 1971, *Pedestrian Planning and Design*, John J. Fruin identified and quantified the body ellipse, a plan view space roughly 18" x 24" which defines the actual body space for the average individual. This measurement is useful when considering the streetscape elements a given sidewalk width can bear without sacrificing pedestrian capacity or comfort.

Much like traffic engineers work with “levels of service” (LOS) related to vehicular traffic, Fruin has defined similar LOS for pedestrian spaces. The LOS is a description of the intensity of use and freedom of mobility provided in a pedestrian space.

Fruin describes a LOS as intensity of use. Intensity of use is defined by the number of pedestrians using a space and their average speed of movement. Each successive LOS has an increased intensity of use. For example, LOS “A” spaces offer much more mobility and freedom than LOS “C” areas. The concept of LOS can be directly applied when planning and evaluating a streetscape design.

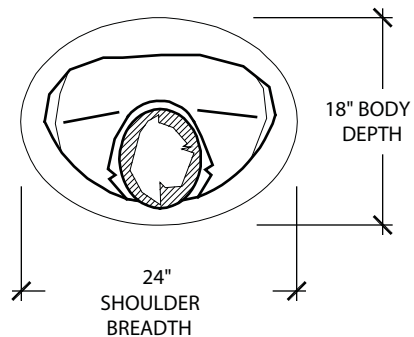

Figure 2-22: Fruin’s body ellipse (Source: Adapted from *Pedestrian Planning and Design*, Revised Edition, John J. Fruin, 1971, Figure 3.15, p. 67)

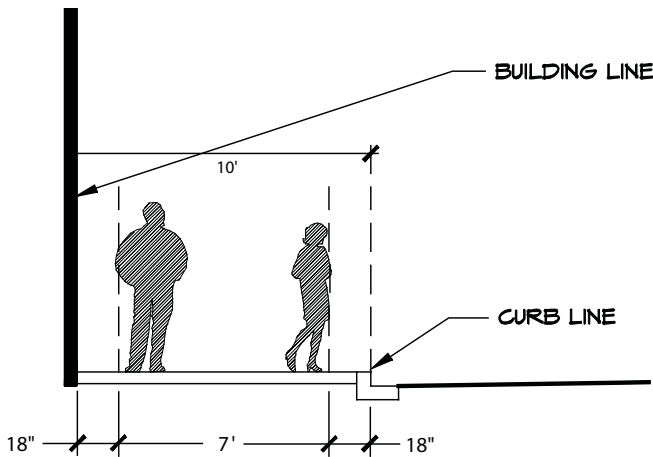

Figure 2-23: Shy zones at building face and curb for a 10' wide sidewalk

Shy Zones

Another useful concept developed by Fruin is the shy zone. When a pedestrian walks alongside a storefront, the pedestrian instinctively maintains a distance, or shy zone, from the storefront. The shy zone occurs around all objects within a streetscape. It also occurs at the curb line where pedestrians instinctively stay away from curbs unless waiting to cross into parking spaces or crosswalks. Objects placed in the streetscape actually consume more space than their actual physical dimensions due to this shy zone effect.

A sidewalk that is 10' wide from curb face to building face has the shy zones indicated in Figure 2-23. The shy zone creates a net 7' wide sidewalk zone where pedestrians feel comfortable traveling. As the number of pedestrians increases, the net pedestrian space gets more crowded, impacting the personal space of individual pedestrians. To accommodate this compression, pedestrians will encroach into the shy zone areas in an effort to maneuver along the streetscape. Although a pedestrian can physically traverse the streetscape in this situation, attention is on safe passage rather than enjoying the streetscape or window-shopping. Since the overall goal in streetscape design is to create an environment in which pedestrians feel comfortable and to entice them to return, the shy zone effect must be carefully considered in the design process.

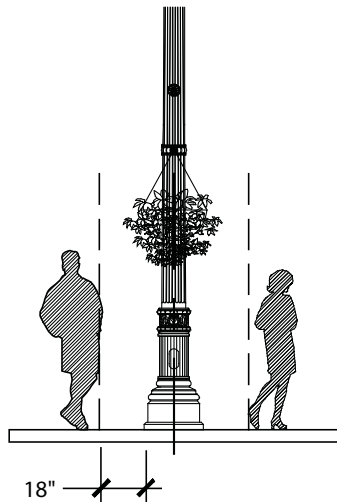

Figure 2-24: Shy zones at light poles

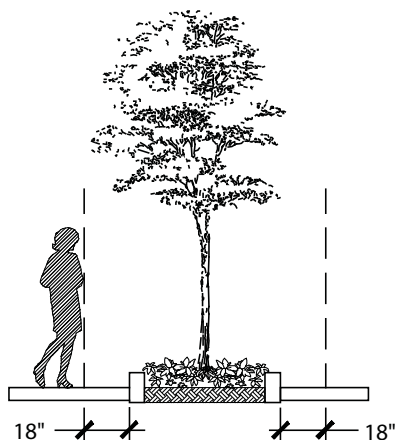

Figure 2-25: Shy zones at planters

The space available between the curb line, element line, and building face helps to determine what form the major streetscape elements can take within the streetscape. Balance of elements and breaches in the element line must also be accommodated. Therefore, narrow spaces have more limitations on the scale and size of streetscape elements that can be accommodated and this is compounded by the shy zone effect. More opportunities with a greater level of service are possible as the space widens.



Figure 2-26: Maintenance is critical to the aesthetics of the streetscape



Figure 2-27: Hanging baskets require a high level of community commitment to maintenance

MAINTENANCE AND COMMUNITY COMMITMENT

The capital investment in a community via streetscaping should not be a short-term project, but one that will have a lasting positive impact. Unfortunately, the natural elements and industrialized environment in which we live take a toll on infrastructure improvements.

Materials, furnishings, and plantings used in streetscape projects are selected for their durability as well as ease of maintenance, servicing, and replacement. But no matter how durable original materials are, or how well they are installed, they will not last without regular maintenance. This is especially true in the case of landscape plantings which require regular and active maintenance to keep them thriving and attractive.

With over 10,000 miles of City streets and landscaping to be cleaned and maintained, standard streetscape items have been established to simplify this enormous task. While property owners do a good job of maintaining their own properties, few owners venture beyond their own property lines into important public areas frequented by customers. Therefore, community “ownership” and “maintenance” of the streetscape improvements (either through voluntary work such as weeding, watering, and general repair, or through monetary assessments for contracted work) are essential to the long-term viability of a streetscape project.

While many City agencies play a role in streetscape maintenance and upkeep, there are a variety of programs that help bring both economic and physical community involvement in streetscape maintenance. (See Appendix B for more information about these programs and community maintenance involvement.)



FUNCTIONAL REQUIREMENTS



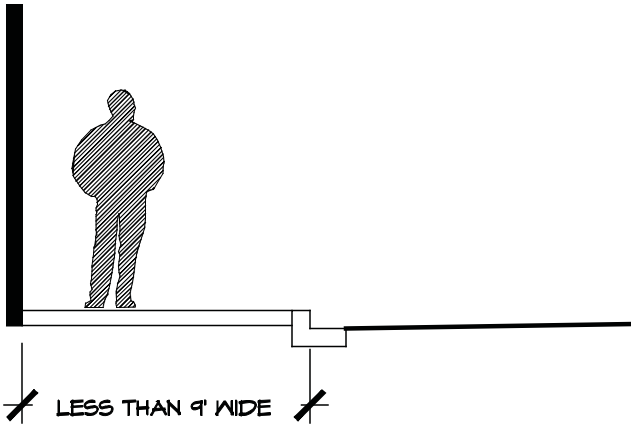

Figure 3-1: Sidewalk less than 9' wide

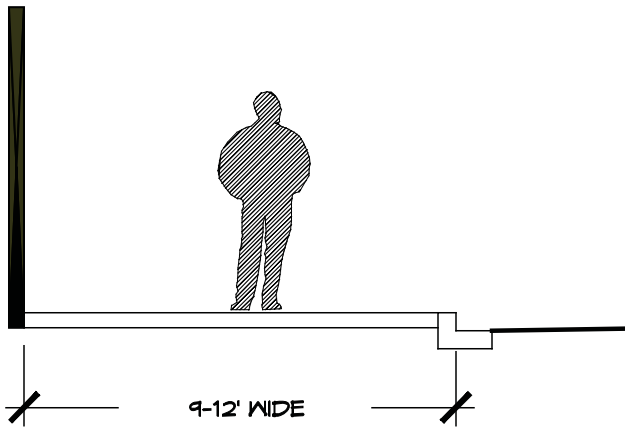

Figure 3-2: Sidewalk 9'-12' wide

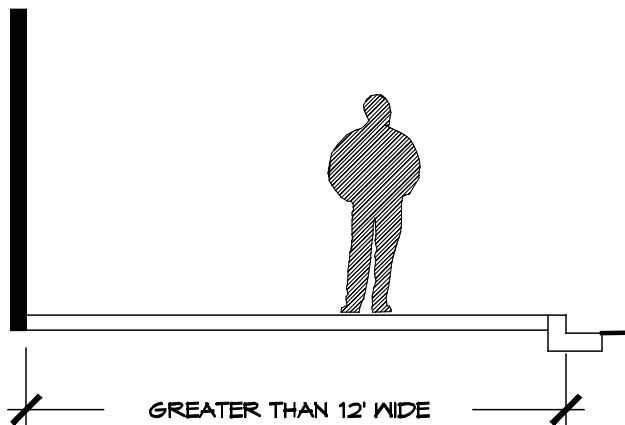

Figure 3-3: Sidewalk greater than 12' wide

FUNCTIONAL REQUIREMENTS

The repetition of standard elements provides the backbone of the streetscape and defines its overall feel. However, successfully accommodating existing and special conditions is also an important part of streetscape design. Dealing with these conditions provides the challenge, and opportunity, to create solutions that not only harmonize with the overall fabric of the streetscape, but also increase its safety, accessibility, and overall functionality.

SIDEWALK CLASSIFICATIONS

Sidewalk width sets the stage for the streetscape, as it is the location in which the elements reside. Narrow spaces have greater limitations on the scale and size of elements that can be placed within the streetscape, while wider sidewalks offer more options.

There are a variety of sidewalk widths on the streets of Chicago, each with their own design challenges and opportunities. The following categories have been developed to illustrate the extent of streetscape improvements various sidewalk widths may accommodate:

- Less than 9' wide
- 9'-12' wide
- Greater than 12' wide

Once the sidewalk category has been established, the design process can begin.

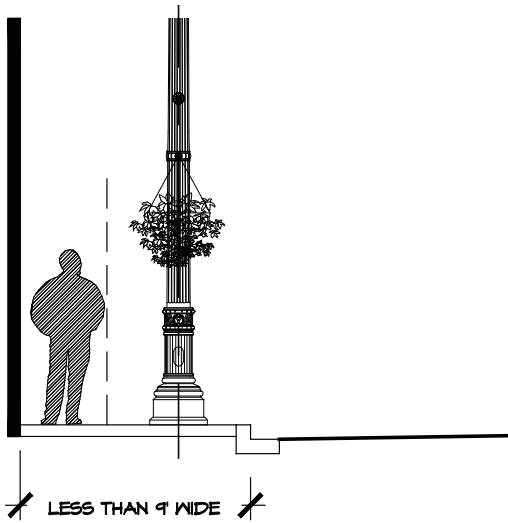

Figure 3-4: Shy zones in a sidewalk less than 9' wide

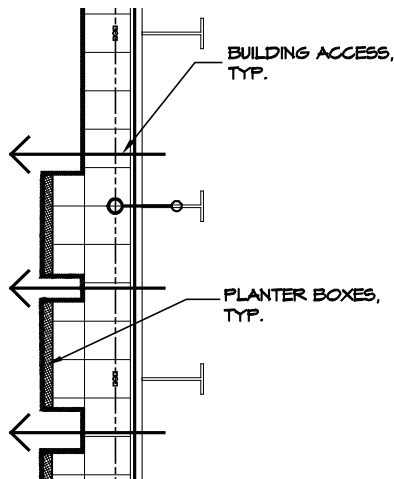

Figure 3-5: Long, narrow planters along the building face, placed by private owners, may satisfy the Chicago Landscape Ordinance while allowing for adequate pedestrian levels of service and accessible routes.



Figure 3-6: Hanging baskets offer an opportunity to add landscaping in a narrow sidewalk condition

Sidewalks Less than 9' Wide

Sidewalks in this category are the most challenging due to limited space available for pedestrians and the installation of streetscape elements. The shy zones at the building face and curb face can create net pedestrian zones of 5' or narrower. There is very little space for making improvements. When designing streetscapes in sidewalks this narrow, it is important to note that a minimum clear sidewalk width of 5' should be maintained. A 3' clear sidewalk width is required per the Americans with Disabilities Act Accessibility Guidelines.

The Chicago Landscape Ordinance stipulates landscaping requirements for the sidewalk zones and therefore has a major influence on streetscape design. According to the ordinance, street trees are not required when the sidewalk zone is less than 9' wide, and they are not recommended in this condition by the Streetscape and Urban Design Program. In this situation, plantings may be added to the streetscape by alternative means, such as:

- Hanging baskets on light poles
- Private planter boxes along buildings or hanging from adjacent buildings
- Sidestreet curb extensions at intersections with large planters
- Planter pots in the element line

A caveat to all of these solutions is the level of maintenance the community can perform. The maintenance of hanging baskets and planter pots is costly and requires a significant commitment by the community. A community commitment to maintenance is critical if such improvements are to be included in the streetscape.

Sidewalks 9'-12' Wide

Sidewalks 9'-12' wide offer more flexibility than the previous category. According to the Chicago Landscape Ordinance, when the sidewalk zone is 9'-12' wide street trees must be planted in tree grates.

- For 9'-10' wide sidewalks, 4' x 6' tree grates are recommended. Tree grates would be installed directly adjacent to the back of curb.
- For sidewalks 10'-12' wide, 4' x 6' or 5' x 5' tree grates are recommended. Tree grates would be installed 1' from the back of curb.

Sidewalks in the 9'-12' wide category can also accommodate benches, kiosks, and small community identifiers.

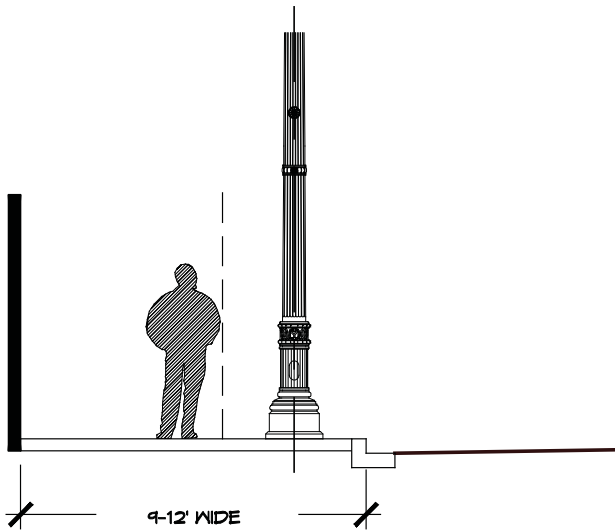

Figure 3-7: Shy zones in a sidewalk 9'-12' wide



Figure 3-8: 10' width sidewalk condition



Figure 3-9: Free-standing planters, provided by the owner, interspersed with trees in tree grates

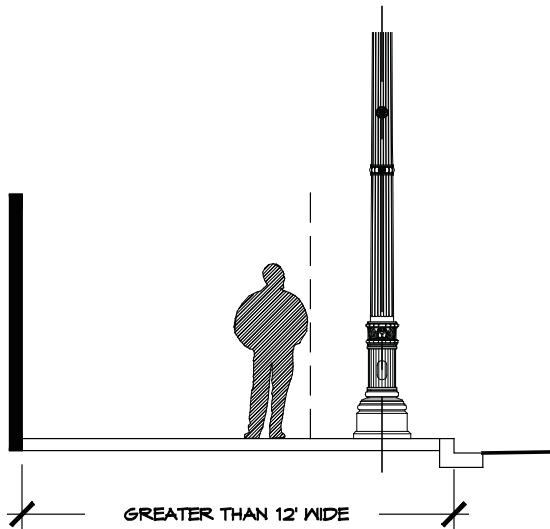

Figure 3-10: Shy zone in a sidewalk greater than 12' wide

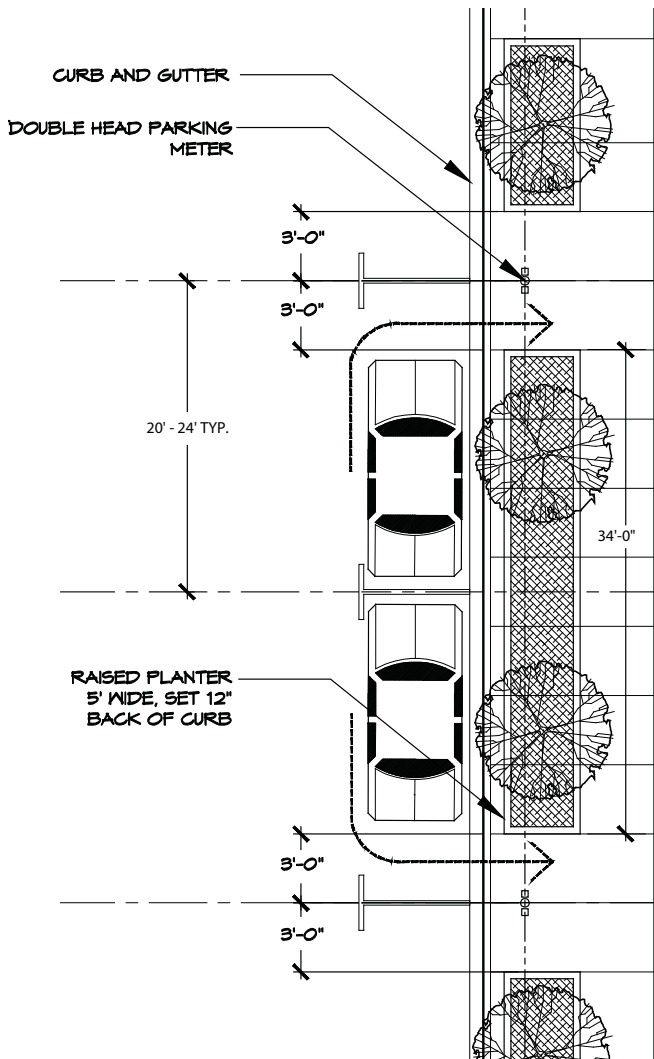

Figure 3-11: Limiting planter lengths to allow for access to vehicles and businesses

Sidewalks Greater than 12' Wide

This sidewalk width offers the most flexibility. However, even with extra space, care must be taken to preserve pedestrian flow and accommodate various levels of service.

The Chicago Landscape Ordinance requires street trees to be planted in continuous parkway planters when the sidewalk zone is greater than 12' wide. Planters should be as long and continuous as possible while still providing sufficient business and pedestrian access from the parking zone. Pedestrians and delivery persons must have access from parking spaces and loading zones. Utilities and other elements in the streetscape will also determine the location and frequency of breaks between planters. It is also important to consider sight lines when installing planters, especially at intersections. Once again, the level of maintenance the community can perform should be considered when determining the quantity and size of the planters and the landscape treatments to be installed in each planter.

In addition to more green space, wide sidewalks can usually accommodate more street furniture and amenity elements, including vertical elements, bus patron shelters, and public art.



Figure 3-12: In-ground planter

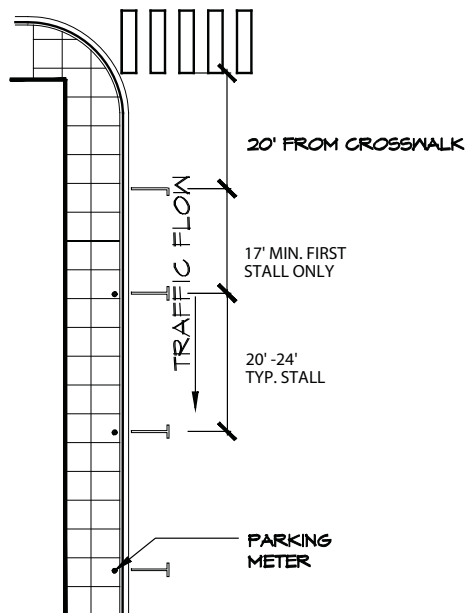

Figure 3-13: Parking module at intersection

The options and scope of a streetscape design are predominately dependent upon the width of the sidewalk. Although wider sidewalks allow greater variety in organizing elements in the streetscape design, they must also accommodate specific Chicago Landscape Ordinance requirements from which narrower sidewalks are exempt. (See Chapter Four for further discussion of the Chicago Landscape Ordinance.)

PARKING

Parking is another important functional requirement that the streetscape must address. One of the key objectives of the Streetscape and Urban Design Program is to promote neighborhood commercial, economic, and social development. To successfully promote commercial districts, parking is an essential component. Most City streets have parking on at least one side of the street, although there are several cases when parking is restricted completely. These include:

- High traffic streets
- Snow routes, on snow days
- Fire hydrants
- Public transportation stops and stations
- Loading zones
- Rush hour restrictions



Figure 3-14: Angled parking

Parallel parking on City streets within commercial areas is considered standard. A limited amount of angled parking occurs, and may be appropriate, on side streets adjacent to commercial areas. Angled stalls present a significant safety challenge by requiring the driver to back out into oncoming traffic. Adjacent larger vehicles often limit sight distances



Figure 3-15: Angled parking with planter

Specific guidelines have been developed to determine the feasibility of angled parking. These requirements are different for one-way and two-way streets. In addition, the existence of mature trees, driveways, loading zones, and low-height residential windows must also be examined.

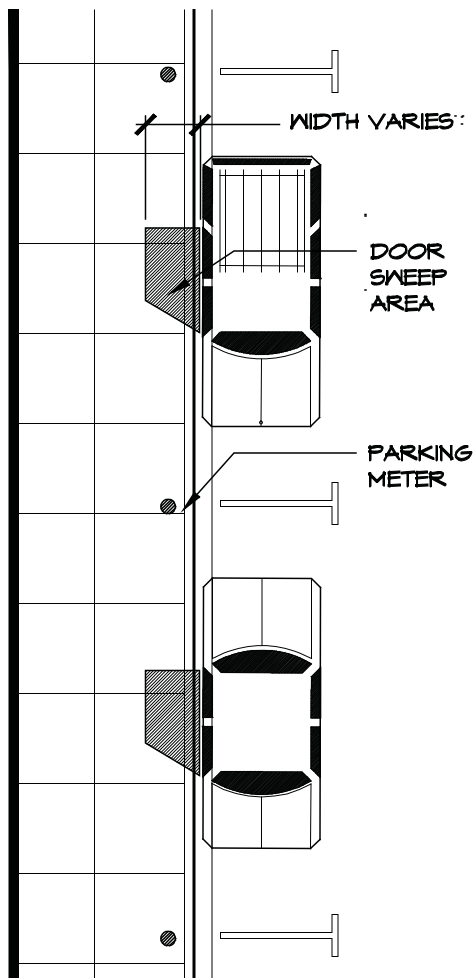

Figure 3-16: Door sweeps



Figure 3-17: Typical parallel parking

Whenever possible curb extensions with planters should be installed at the street corners and alley ends of the diagonal parking area. This adds green space and helps screen the parking.

The Streetscape and Urban Design Program works with the CDOT Bureau of Traffic to determine where angled parking can be installed. Angled parking is not installed on arterial streets, but may be placed directly adjacent to them along side streets between the arterial and the alley.

Parallel parking stall dimensions vary slightly: 8' wide by 24' long is considered a good standard for maneuvering. Parking stalls that are at the ends of the block can be down-sized to a length of 17'-20'.

Parking stall dimensions dictate the placement of parking meters within the streetscape. Currently, the City uses both single- and double-head parking meters. Double-head meters have an advantage in the streetscape as they reduce the number of elements, which may be helpful aesthetically and functionally. The Chicago Department of Revenue is conducting pilot projects that include other methods of collecting parking fees, however, parking meters are currently the only streetscape option.

Parking stalls also affect the overall streetscape due to the influence of passenger doors opening into the sidewalk and roadway zones. Passenger doors of legally parked vehicles open outward over the curb and into the adjacent sidewalk zone. Door sweeps need to be accommodated in the placement and arrangement of streetscape elements along the pedestrian zone. Placing elements within sweep zones can prohibit or limit opening passenger doors, causing damage to both the doors and to the streetscape elements, and can severely restrict the accessibility and use of disabled pedestrians in the sidewalk and parking zones.



Figure 3-18: Side street streetscape improvements

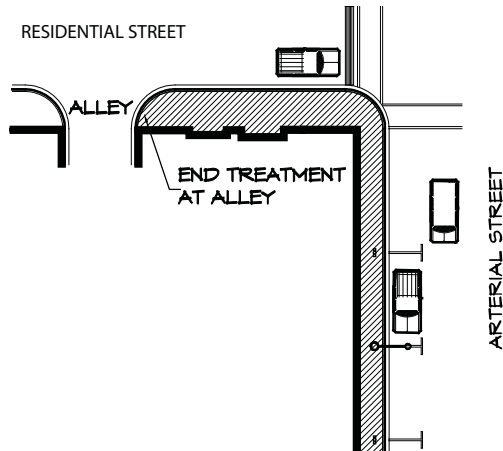

Figure 3-19: Streetscape treatment wraps around corner and extends to alley



Figure 3-20: Streetscape improvements wrap the corner and extend to the alley at a curb extension

CORNERS

Corners are where pedestrians gather and make directional decisions. To highlight the importance of these areas, streetscape treatments may be upgraded at corners, including the use of special pavements, seating, lighting, and other street furniture elements.

During the design process, the streetscape designer should consider how to wrap the corners of the streetscape and to what point the streetscape extends down side streets. Typically, the Streetscape and Urban Design Program includes basic infrastructure upgrades on the side streets of a project from the corner to the alley, or approximately 125' along the side street. Diagonal parking may also be provided as part of the streetscape project.

Streetscape treatments can extend to building corners, window corners, other logical building breaks, or alleys. The goal is to end the streetscape in a way that blends within the context of the neighborhood and immediate surroundings.

Figure 3-14: Angled Parking



Figure 3-21: Free-standing planter at curb extension



Figure 3-22: Community identifier at curb extension

CURB EXTENSIONS

As a variation on standard corner treatments, curb extensions create additional pedestrian space in place of vehicular surfaces. When allowed, curb extensions can be used at intersections on side streets or at the middle of the block. A typical curb extension is 7' wide and 20'-30' long.

Curb extensions have the following features:

- They shorten the distance that a pedestrian must travel to cross a street. Pedestrians will feel safer in these expanded pedestrian zones.
- They increase the sight distance between motorist and pedestrians crossing the street.
- They create additional pedestrian space that can be used for amenities, bus patron shelters, and landscape treatments.

Careful traffic and parking analyses must be performed to determine the location of curb extensions and whether or not they are appropriate for a specific streetscape. In addition, curb extensions need to be carefully coordinated, with the various City agencies, including the Chicago Transit Authority (CTA) and CDOT Bureau of Traffic.



Figure 3-23: Curbed planter at curb extension



Figure 3-24: Stamped asphalt crosswalk



Figure 3-25: Unit paver raised crosswalk

CROSSWALKS

Crosswalks are where pedestrians are legally allowed to cross City streets. The Manual on Uniform Traffic Control Devices provides guidelines for marked crosswalks, as well as standards and guidelines for crossing improvements. This document should be used in combination with professional judgment and specific traffic engineering analysis on a case-by-case basis when designing crosswalks. Pedestrians have the right to cross the street in the safest way possible, and crosswalks should be designed accordingly (Source: “Guide for the Planning, Design, and Operation of Pedestrian Facilities, AASHTO Draft August 17, 2001)

At intersections, crosswalks are defined as the extension of a sidewalk or shoulder across an intersection, whether marked or not. (Source: “Guide for the Planning, Design and Operation of Pedestrian Facilities”, AADAG, 2001).

Marked crosswalks generally consist of two parallel lines perpendicular to the direction of traffic. Crosswalks vary in width and should align with the edge of the right-of-way on one side. Typically they are 6'-10' wide and should be set back 2' from back of curb.

Crosswalks can become an important element in the streetscape environment by physically and visually linking opposite sides of the street. This continuation of the pedestrian zone through the parking and vehicular zones can be accomplished not only by striping, but by using various materials and patterns that may already occur in the streetscape.

Both pavers and stamped asphalt have been used by CDOT to delineate crosswalks and individualize them as elements of the streetscape. The Streetscape and Urban Design Program has selected a standard for stamped asphalt, which can be used to decorate and highlight the crosswalk area. The use of pavers in the crosswalk is experimental and not an approved standard.

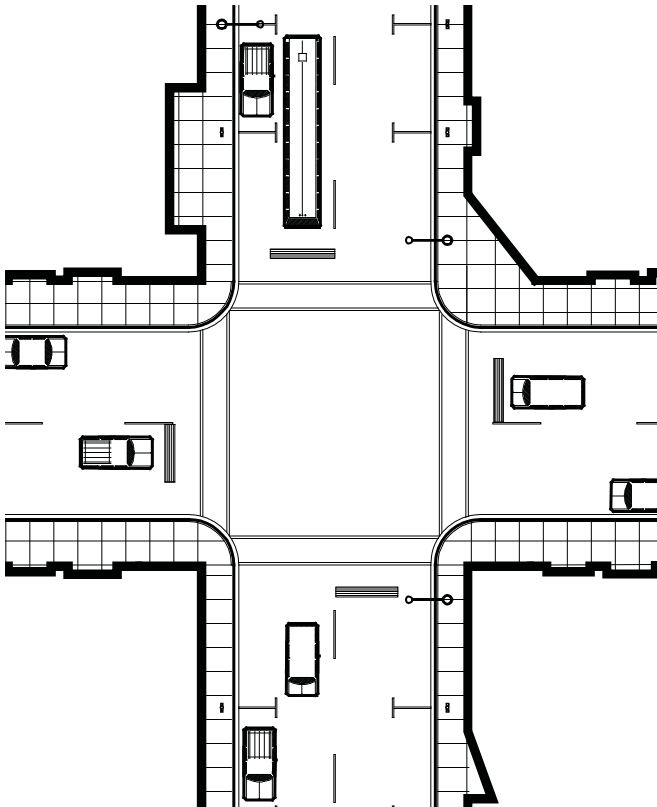

Figure 3-26: Typical crosswalk configuration

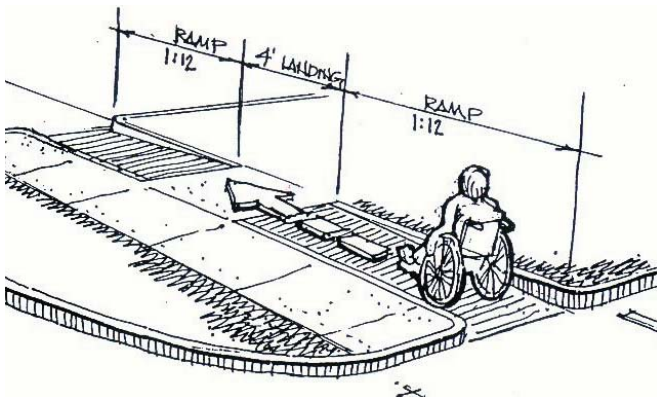

Figure 3-27: Median refuge
 (Source: "Accessible Rights-of-Way: A Design Guide," U.S. Architectural and Transportation Barriers Compliance Board [The Access Board], November, 1999.)

Another crosswalk technique is to raise the crosswalk area, a feature referred to as a speed table. This raised crosswalk increases the visibility of the crosswalk and makes it more apparent to drivers. It also slows down traffic, similar to a speed hump. Speed tables may only be used in special areas designed for slow moving traffic and are not appropriate for arterial streets. In addition, the CDOT Bureau of Traffic must approve the use of speed tables.

Where distances across the vehicular zone are wide and traffic patterns allow, an intermediate island, or median, may be used as a crosswalk technique. Medians provide pedestrians with a refuge area in which they can wait for a break in the traffic.

MID-BLOCK CROSSINGS

In rare cases it may be appropriate to install a crosswalk at the middle of the block. Since vehicles may not expect a crossing in an area where they generally are not required to stop, these areas must be carefully studied and well marked. International crosswalks, a series of parallel lines running in the direction of traffic, are typically used in combination with traffic calming devices, such as warning signs, increased lighting, crossing islands, and curb extensions. Again, the CDOT Bureau of Traffic must approve the use of mid-block crosswalks.

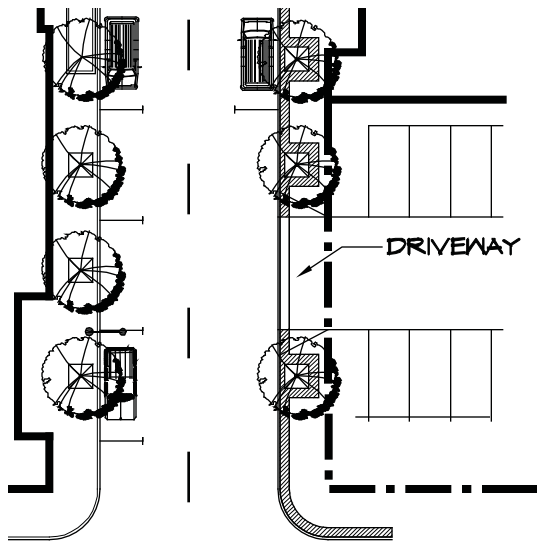

Figure 3-28: Driveways need to be treated aesthetically as a pedestrian surface

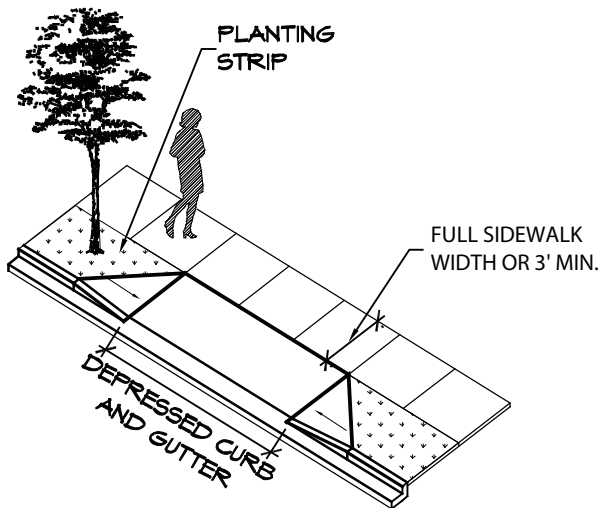

Figure 3-29: On side streets, parkways allow the pedestrian surface to remain level

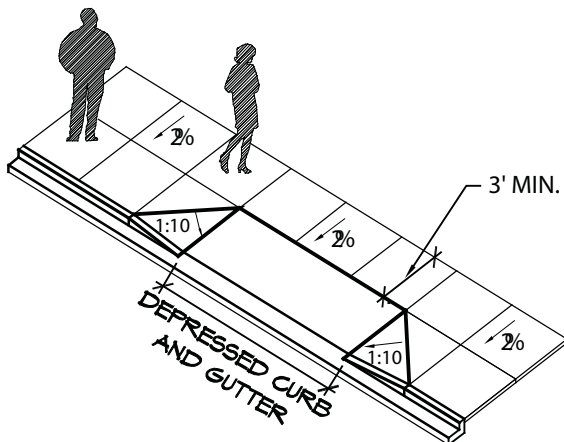

Figure 3-30: Driveways that match the cross slope of the sidewalk create a continuous pedestrian surface

DRIVEWAYS AND ALLEYS

Driveways into parking lots, garages, and other properties often create a challenge for the streetscape designer. Driveways may create a breach in the fabric of the streetscape where the module elements may need to be adjusted or deleted to accommodate the driveway function.

Because driveways cross the pedestrian zone, they need to be treated as a pedestrian surface. Whenever possible, the pedestrian surface should appear to be unbroken as the pedestrian travels through the streetscape and across the driveway.

Property owners with driveways must have a current and valid permit for right-of-way use. This permit must be obtained through the Chicago Department of Revenue. Without a permit, the City will not reinstall the driveway when pouring the new sidewalk.

Alley aprons are treated similarly to driveways and must be constructed using heavy-duty pavements to withstand the heavy wheel loads created by refuse trucks, fire trucks, and similar vehicles. However, alleys are usually designed more like street intersections with a definite break in the sidewalk and standard curb returns with 5'-10' radii. The full pedestrian accessibility of alley crossings must be considered when using standard curb returns on alleys. As at intersections, curb ramps may be required at alleys to provide for full pedestrian accessibility.

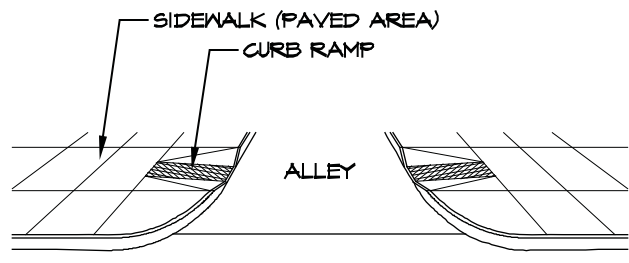

Figure 3-31: Alleys with standard curb returns must be universally accessible and may require curb ramps



Figure 3-32: Valet parking loading zone

LOADING ZONES

Loading zones are designated areas in the parking lane for the loading and unloading of deliveries to buildings. Loading zones are usually requested by merchants or building owners through their Aldermanic office. If the decision is made to proceed, the Alderman introduces an ordinance to City Council requesting that the loading zone be approved. Upon approval, the CDOT Bureau of Signs and Markings and Chicago Department of Revenue are informed so that appropriate signs can be installed and, if necessary, parking meters can be removed.

Several considerations are involved when requesting a loading zone. First, if possible, loading should be done from the alley if one is available. If this is not an option, the location and length of the zone, the hours of use, and whether it is for a special use, such as valet parking, must be determined. When determining loading zone location and length, a critical consideration is the size of the vehicles that will be using the zone and the ease of access. For example, large semi-trailer trucks have limited maneuverability, therefore it may be appropriate to locate loading zones for these trucks at the end or beginning of the block where they can easily pull in and out. Another important consideration is potential traffic congestion. Depending on the use of side streets and their widths, it may be more appropriate to locate loading zones around the corner on the side street rather than on the main arterial street so that traffic is not stopped while vehicles are maneuvering or off-loading supplies. If parking is in demand, limiting the hours when the zone is active, and installing parking meters for use when the zone isn't active, can help diminish this issue.

It is important to consider the location of loading zones when placing streetscape elements. The installation of trees, planters, and street furniture should be avoided in these zones to accommodate accessibility and avoid damage to the elements themselves.



Figure 3-33: Vaulted sidewalk reconstruction



Figure 3-34: Vaulted sidewalk reconstruction

VAULTED SIDEWALKS

The City of Chicago maintains a Vaulted Sidewalk Program through the CDOT Bureau of Streets specifically for dealing with vaults in the public way in residential areas. However, when vaults occur within the boundaries of a streetscape project, repair and replacement of the vaults will become part of the project.

Sidewalk vaults date back to the 1830’s and 1840’s and were used for a number of purposes. Starting in the 1950’s, the City has sought to fill and seal these vaults as a safety measure for both pedestrians and building owners alike. When a vault is noted within a streetscape project, special, and more expensive, procedures are used for sidewalk reconstruction. First, a wall is built at the property line. If existing private utilities are present, they are moved, at the owner’s expense, to the interior of the new wall. The vaulted area between the property line wall and the curb line wall is then filled with granular material, compacted, and sealed with a concrete sidewalk.

If a building owner expresses interest in keeping a vault open, the owner must apply for a vaulted sidewalk permit and pay an annual fee to the Chicago Department of Revenue. This fee must be paid before the vaulted walk will be reconstructed.

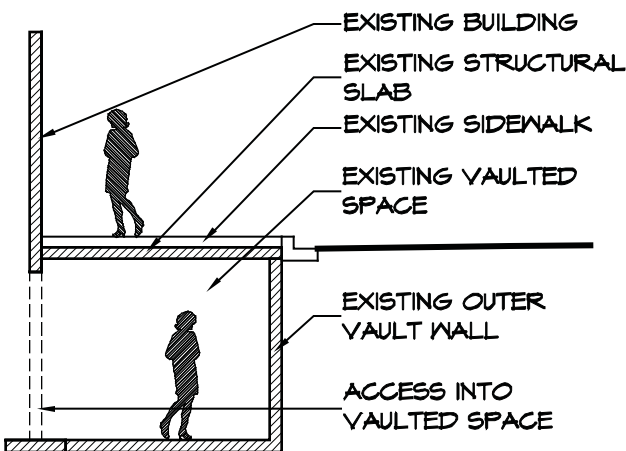

Figure 3-35: Vaulted sidewalk prior to reconstruction

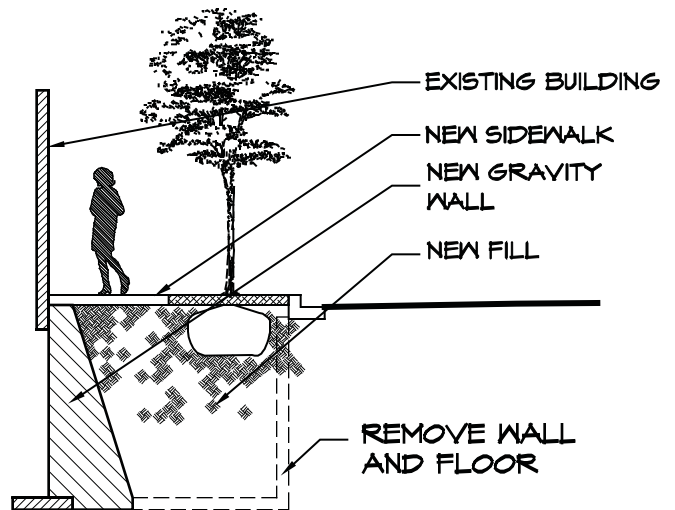

Figure 3-36: Vaulted sidewalk after reconstruction

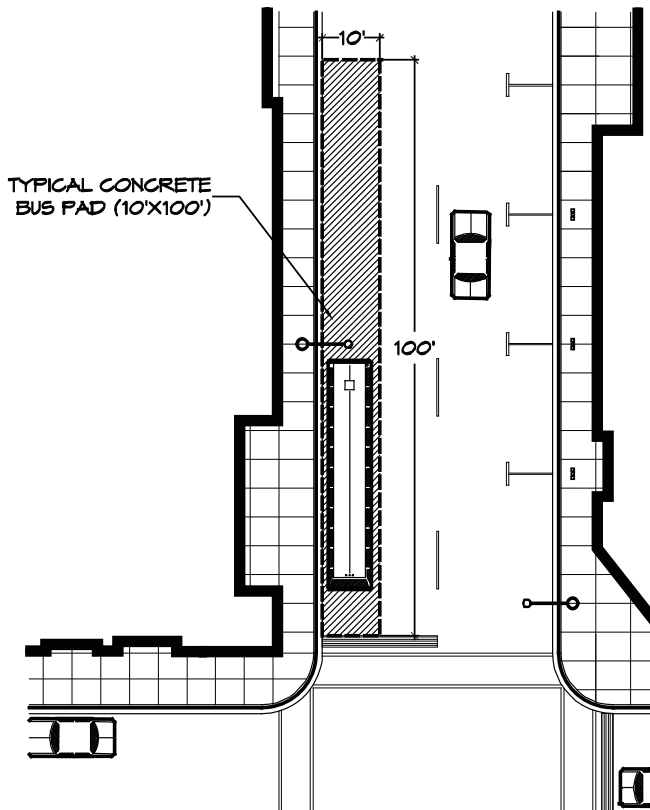

Figure 3-37: Typical bus pad



Figure 3-38: Typical bus pad

BUS STOPS

The CTA has developed a set of guidelines for transit-supportive development. In those guidelines, the CTA recommends minimum sidewalk widths needed for the access and egress from buses, both for sheltered and non-sheltered bus stop facilities. The standard bus patron shelter requires a minimum 12'-6" sidewalk width and is either 5'-4" x 9' or 5'-4" x 13'. Shelter installation is 38" from back of curb and must maintain a 4' minimum clear sidewalk. In some cases, a smaller 4' wide shelter may be installed 12" from the property line, thereby allowing a shelter to be placed in sidewalks as narrow as 8'-10". Shelters must be placed at least 7' from adjacent light poles and 3' from all other objects. According to the Chicago Landscape Ordinance, parkway trees should be placed no closer than 40' from bus stops on the near side of the intersection and 75' at the far side of the intersection.

While typically an alderman or local chamber of commerce applies to the CTA for a new bus patron shelter, the Office of the Mayor has instituted a new Street Furniture Initiative that is designed to provide bus shelters to neighborhood areas from a City-contracted vendor. This program is handled directly by the Office of the Mayor and is not part of the Streetscape and Urban Design Program, however coordination between these two entities occurs as needed.

BUS PADS

The Chicago Department of Transportation has a policy of constructing a 10" thick, 10' x 100' concrete pad at the most heavily used bus stop locations. This is to discourage premature deformation of the asphalt pavement at locations where buses make repeated stops on a daily basis. Generally the CDOT Bureau of Highways installs bus pads during road infrastructure work. However, when significant roadwork occurs as part of a streetscape, bus pads may be incorporated into the project.



Figure 3-39: North Avenue median



Figure 3-40: Irving Park Road median

MEDIANS

The City of Chicago has an active Median Program operating throughout the City. Medians are considered on wide streets and where there is an existing raised or painted median currently in the roadway.

CDOT Bureau of Highways handles the implementation of new medians and has developed a number of standards for median design and construction. These standards address traffic planning issues, such as turn-bay lengths and tapers. In addition, the CDOT Bureau of Highways uses the AASHTO standards for sight distance when designing the median planters and landscape plantings.

Medians may be incorporated into the streetscape program when appropriate.



Figure 3-41: LaSalle Street median

BIKE LANES

In an effort to promote recreation, better air quality, and environmental awareness, the City of Chicago has implemented a citywide bicycle plan. This plan includes provisions for installing bike lanes on arterial streets in order to promote greater bicycle ridership among citizens and ultimately decrease auto dependency.

The following are some of the minimum desirable dimensions and requirements for bike lanes:

- Typical bike lane width is 5'. Placement of the bike lane is directly adjacent to the parking lane. For a standard 66' ROW, this allows for a 44' pavement width, giving a 10' travel lane width in two directions, and a parking lane width of 7'.
- At approaches to channelized intersections, bike lanes are not distinguished. Delineation striping stops 125' prior to the intersection. Bicycles share the road with cars in the right turn lanes or thru lanes.

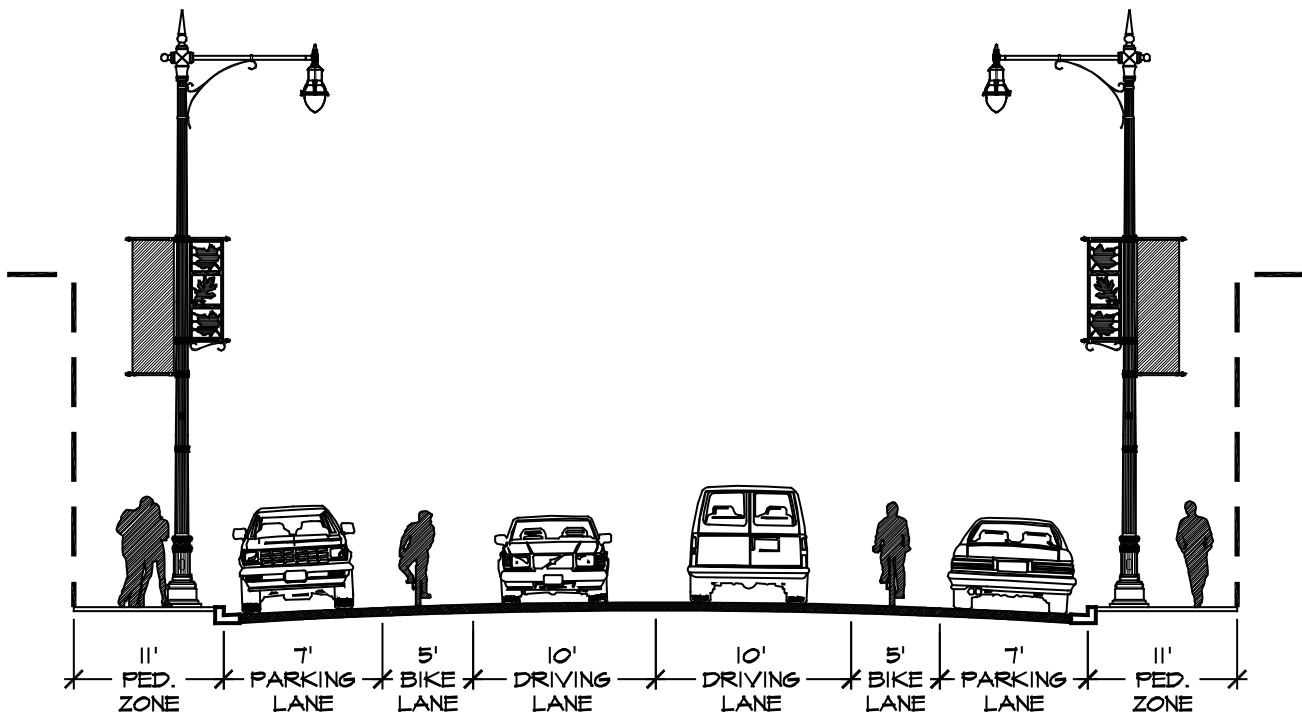

Figure 3-42: Typical bike lane right-of-way cross section



Figure 3-43: Bike lane



Figure 3-44: Bike lane with bike lane markings

Bike lanes achieve a shared streetscape experience between the sidewalk, parking lane, and travel lanes. The impact of a bike lane on a neighborhood may be to encourage further bike-oriented travel, which helps reduce traffic congestion and pollution. This is especially true for short trips of five miles or less.

The City of Chicago Bicycle Program determines locations for, and installs, bike lanes. The Streetscape and Urban Design Program coordinates all projects with the Bicycle Program and installs bike lanes when appropriate. When existing bike lanes are present in an area slated for streetscape improvements, they must be carefully incorporated into the design of the streetscape.



Figure 3-45: Howard Street viaduct

VIADUCTS

It is important to consider viaducts that cross, or are directly adjacent to, a potential streetscape. These structures often act as a gateway into a community or they may act as a barrier, separating the community. Although these structures are often not owned or maintained by the City of Chicago, they have a dramatic impact on the look of a community and should be considered during the streetscape design process, if budget allows.

SPECIAL SECURITY ISSUES

In the aftermath of the terrorist attacks of September 11, 2001, the occasional need for specially designed security barriers in the public way at selected sensitive buildings has become a new streetscape design issue. In these situations, it is important to retain a pedestrian-friendly environment. This includes maintaining a clear pedestrian path throughout and incorporating plantings and street trees whenever possible.

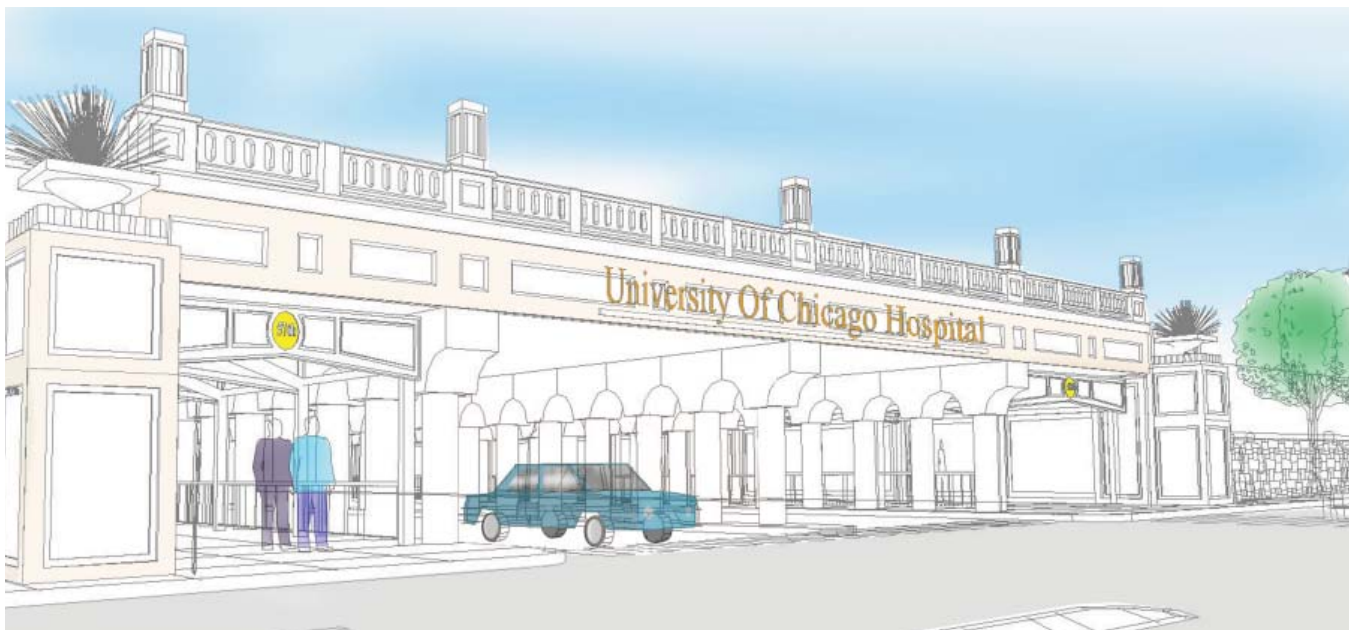

Figure 3-46: Lake Park viaduct rendering



STREETSCAPE ELEMENTS





Figure 4-1: Lincoln Square neighborhood

STREETScape ELEMENTS

This chapter will explore the streetscape elements that have been adopted for streetscapes in the City of Chicago. Some of the elements are standards for use throughout the City, including benches, trash receptacles, and lighting. These elements have been standardized in order to make maintenance and repairs easier to accomplish. Other elements, while standard, have more flexibility in their application and usage for aesthetic variety. This chapter describes options for each streetscape element and provides guidance on their selection and use.



Figure 4-2: Hegewisch neighborhood



Figure 4-3: 53rd Street



**Chicago Gateway
2000 Pole**
**Single Acorn
Pedestrian Pole**

Figure 4-4: Two of the standard lighting palette poles

LIGHTING

All three zones of the streetscape, vehicular, sidewalk, and parking, must be properly lit. One of the goals of the Streetscape and Urban Design Program is to move overhead wires to an underground trench beneath the sidewalk. This change removes from the landscape the mass of overhead wires that often defined the City street, and has brought back the light fixture as a clarifying element of the streetscape.

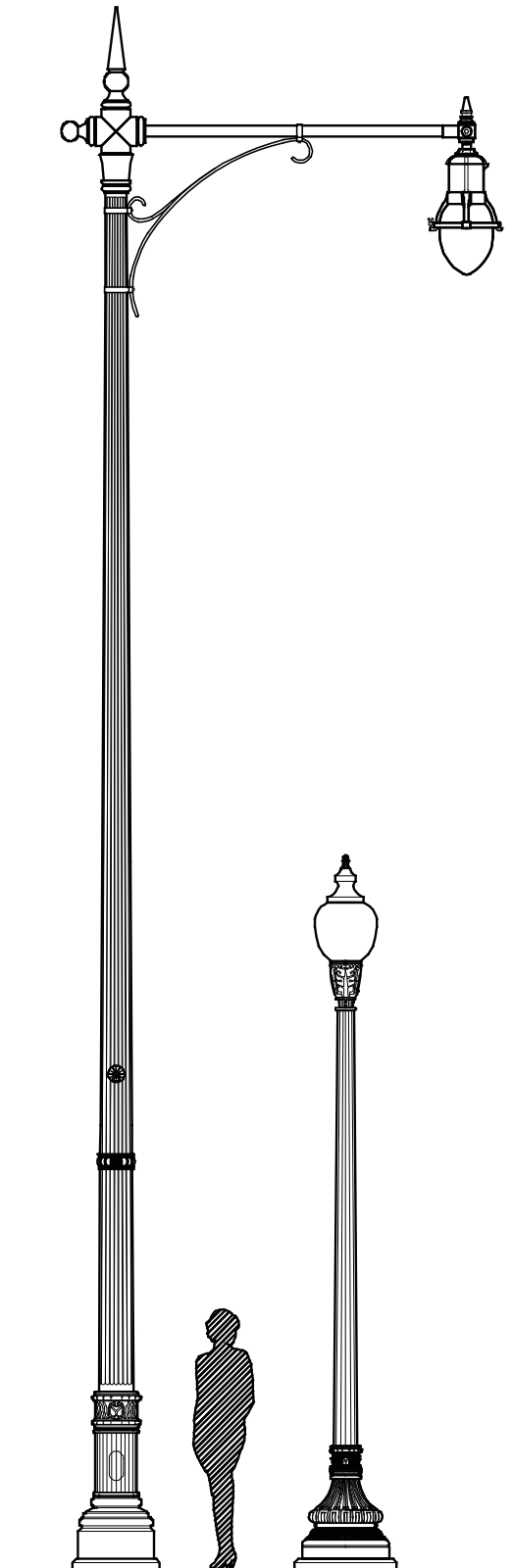
The City of Chicago has adopted the Loop Light Master Plan and the Chicago Street Lighting Master Plan to standardize lighting in the City. Both of these resources are available through the Chicago Department of Planning and Development. The City of Chicago Street Light Selection Matrix, a key component of the Chicago Street Lighting Master Plan, presents the options for lighting in Chicago. The matrix uses several variables to determine the exact style and spacing for lighting in a streetscape. The main criteria used for this matrix are:

- Right-of-way width
- Sidewalk width
- Street wall height

When designing a streetscape, photometric studies are performed in order to determine the appropriate height, wattage, and spacing of each light within a streetscape project area. On average, the City of Chicago's required illumination levels are 2.5 foot candles on streets, 5 foot candles at intersections, and 1.5 foot candles on sidewalks.



Figure 4-5: Chicago Gateway 2000 pole

Vehicular Lighting

Most importantly, lighting must be provided for vehicular traffic. The City of Chicago has two primary light poles for this use: the Chicago Gateway 2000 pole and the Davit Arm pole. These poles are designed to provide illumination over large areas of the right-of-way as efficiently as possible. They vary in height but are usually about 34' in height and have high wattage luminaires. The Davit Arm pole has a cut-off fixture while the Chicago Gateway 2000 pole has a semi-cut off fixture. This means that they direct the light down onto the roadway and sidewalk, instead of up or out. This saves electricity and helps maintain “dark skies.” They also reduce glare and therefore increase driver visibility.

Type IV lenses are used on the Chicago Gateway 2000 poles. While traditional lenses spread light in a circular pattern, Type IV lenses spread light in an oval pattern along the length of the street. This concentrates light on the right-of-way where it is needed, as opposed to the building facades, and allows for greater spacing of fixtures, thereby reducing costs.



Figure 4-6: Chicago Gateway 2000 pole, luminaire, and mast arm



Figure 4-7: Davit Arm pole



Figure 4-8: Single Acorn pedestrian pole



Figure 4-9: Single Acorn luminaire

Pedestrian Lighting

Almost as important as vehicular lighting is pedestrian lighting. While the Chicago Gateway 2000 pole and the Davit Arm pole illuminate both the vehicular and sidewalk zones to required levels, they often don't provide the "face-to-face" lighting pedestrians prefer. Face-to-face lighting refers to an illumination level that enables a pedestrian to comfortably see the features of oncoming pedestrians and provides a sense of safety.

The primary pole used by the City for pedestrian lighting is the Single Acorn pole. This pole is approximately 16' in height and also uses a Type IV lens. Since the pole is shorter and is not a cut-off or a semi-cut-off fixture, it can produce glare. For this reason a lower wattage lamp is used, usually 100 watts. The Single Acorn fixture is usually staggered in between the Chicago Gateway 2000 or the Davit Arm pole. Due to its wider base it is not recommended for sidewalks 9' wide or less. Since it throws light up and out, it is not recommended where there are many second story residential units.



Figure 4-10: Historic Twin Arm pole



Figure 4-11: The Single Acorn pedestrian pole has a wide base that is difficult to accommodate in narrow conditions

The fourth pole in the City's lighting palette is the Historic Twin Arm pole. This pole provides both vehicular and pedestrian lighting. It has two fixtures that provide enough light to illuminate the street, and the shorter height, acorn-shaped fixtures provide face-to-face lighting and ambience. However, this pole cannot be used at intersections, where lighting levels must be doubled. The Historic Twin Arm pole is available in two heights, 16' and 18'. The 18' height pole is only allowed in the Loop and West Loop (refer to the City Street Light Selection Matrix, available from the Chicago Department of Planning and Development, for exact locations).

While the Historic Twin Arm pole has distinct advantages, it is not appropriate for all locations due to its glare and height. Furthermore, as the right-of-way gets wider, this pole is unable to provide the proper lighting levels without supplemental lighting. Due to its shorter height, the poles must be spaced closer together and therefore it is more expensive.



Figure 4-12: Viaduct lighting on Irving Park Road

Viaduct Lighting

Viaducts present a unique set of challenges and have their own set of standard fixtures. The three standard fixtures include: the Kendale utility fixture, the Holophane utility fixture, and the VCM ceiling mount fixture. These are basic surface-mounted box fixtures with 100-watt, 150-watt, and 250-watt high-pressure sodium lamps, respectively.



Figure 4-13: Hanging baskets



Figure 4-14: Banners on North Halsted Street

Lighting Enhancements

Light poles can also be used to provide other streetscape amenities, including:

- **Hanging Baskets.** The Chicago Gateway 2000 poles and the 18’ height Historic Twin Arm poles can be equipped with a special bracket that will support hanging baskets for additional landscape opportunities.
- **Banners and Permanent Community Identifiers.** Both the Chicago Gateway 2000 and the Davit Arm poles can accommodate banners or permanent community identifiers. (See the “Community Identifiers” section of this chapter for more information.)
- **Holiday Lighting.** Outlets for holiday lighting can be provided on the Single Acorn and Historic Twin Arm poles. Due to concern about the effects holiday lights have on the trees if they remain year round, holiday lighting on trees is only allowed from November 15 to March 15. After March 15 the lights should be removed.



Figure 4-15: Street trees on 53rd Street



Figure 4-16: In-ground planter on Grand Avenue

TREES AND PLANTINGS

In addition to lighting, trees are highly visible elements within any streetscape. As a dominant element, they define spatial volume and rhythm along the length of the streetscape. They provide spring bloom, summer shade, fall foliage color, winter branching, and an opportunity for holiday lighting and decorating during the winter.

Trees provide more than just a decorative element in a streetscape. In addition to softening an otherwise hard urban environment, trees provide a defense against the “urban heat island effect” and protect residents from harsh weather conditions. The Chicago Department of the Environment has measured the benefits of planting trees throughout the City and found evidence of improved air quality and lower energy costs.

The Chicago Landscape Ordinance

The City Council adopted the Chicago Landscape Ordinance in 1991 to promote improved environmental quality and appearance through planting trees and landscaping available space. The urban ecosystem is fragile and the Chicago Landscape Ordinance addresses its health and protection.

Mature trees are rare in the streetscape. Pollution, accidents, insects, vandalism, and disease cause many trees to die and be removed, but lack of proper growing space is one of the primary causes of the premature death of urban trees. The City of Chicago is making great strides in promoting tree health through the Chicago Landscape Ordinance, which requires special growing conditions that give the City’s trees the best chance to reach maturity.

The Chicago Landscape Ordinance promotes trees and other plantings in the streetscape by requiring plantings based on sidewalk width. Trees are to be incorporated into a streetscape through the installation of tree pits or planters. The ordinance also introduces the use of “engineered soil,” a manu-



Figure 4-17: Planter on Oak Street

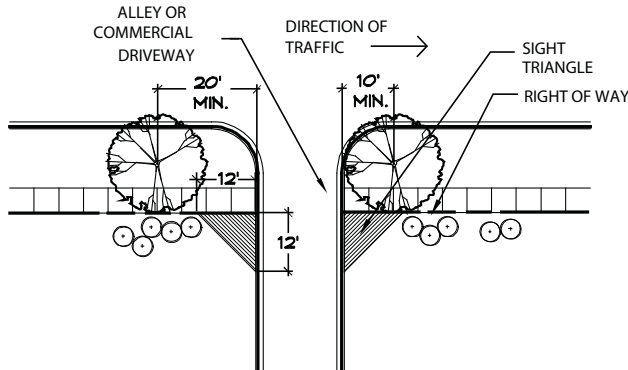

Figure 4-18: Sight triangle at driveways or alleyways

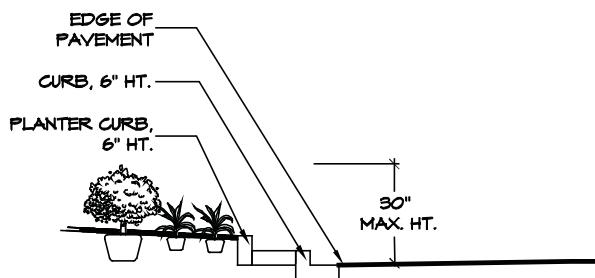

Figure 4-19: Plantings at crosswalks must be no taller than 30" above the top of pavement

factured growing medium designed to provide for adequate continuous root growth while still meeting compaction requirements for pavement construction. The *Guide to the Chicago Landscape Ordinance*, available through the Chicago Department of Planning and Development, summarizes the requirements of the Chicago Landscape Ordinance.

Plant Material

Plant material adds four-season color, interest, and texture to a streetscape. The Streetscape and Urban Design Program’s goal is to maximize green space wherever possible. However, a number of items must be considered to ensure a successful landscape.

Use and Effect: The intended use of the landscape should be at the forefront of the design process. What is this landscape intended to do? Whether the intent is to control traffic, screen or enhance views, provide a background for an adjacent use, or just to soften the existing streetscape, the intended use and its desired effect must be considered in the choice of plant materials.

Plant Height and Sight Triangles: Plant heights must also be considered to ensure safety and security in the streetscape. Sight distance triangles are generally based on the design speed of the roadway. However, at crosswalks the maximum height of plant material shall be 30" from the top of pavement. This means that with a curb height of 6" and a planter curb height of 6," the maximum height of the plant material is 18". Similarly, in a driveway or alley condition, plants over 30" in height should not be located within the 12' sight triangle as measured from the right-of-way.

The Guide to the Chicago Landscape Ordinance further sets the minimum distances trees can be planted from walks, curbs, utilities and other structures in the right-of-way. Please refer to the *Guide to the Chicago Landscape Ordinance* for this and other pertinent information.



Figure 4-20: In-ground planters in the Devon/Central neighborhood



Figure 4-21: Free-standing planter on Halsted Street

Trees must also maintain a minimum branch height. As stated in the *Guide to the Chicago Landscape Ordinance*, the minimum branch height in the Greater downtown area (North Avenue on the North, Lake Michigan on the East, Cermack Road on the South, and Ashland Avenue on the West) is 7' as measured from the top of rootball. The minimum branch height in all other areas is 6'.

Maintenance: Maintenance must also be considered in the choice of plant materials. It is the policy of the Streetscape and Urban Design Program to install plant material only where the community is willing to maintain it. Although no landscape will be successful without some degree of maintenance, some plants require less attention than others. The Chicago Landscape Ordinance states landscape maintenance requirements and schedule for both public and private installations and should be referred to for this information. A sworn statement by the owner committing to the maintenance of the landscaping is also required.

Salt Tolerance: Given Chicago winters and the use of salt, plant material with a high salt tolerance must be used. The Chicago Department of Transportation maintains a list of salt-tolerant plants that they have tested, or are currently testing, for survival success.

Although it is still recommended that salt-tolerant plants be used in this environment, other design features can be incorporated into the streetscape to help ensure the survivability of plants in the streetscape. For example, carriage walks and raised planter beds can be used to increase the distance of the plants from the road. Specially designed salt fencing can be installed during the winter to further protect this investment. The introduction of water in the spring to flush out accumulated salts is also recommended.

Irrigation: One of the most important



Figure 4-22: In-ground planter on Grand Avenue

aspects of landscape maintenance is watering. It is the policy of the Streetscape and Urban Design Program to provide irrigation for planters wherever possible. The program uses two methods of irrigation, automatic irrigation and hand watering. Automatic irrigation consists of underground piping connected to pop-up sprinklers located in the planters. These systems are maintained by the City and perform automatically, usually at night. The hand watering method uses quick-couplers with hose bibs. A standard garden hose can be attached to these for manual watering of the planters. The hose bib is a separate piece that is easily installed and removed to prevent undesired use. Although the City maintains the piping, the hose bib is kept with members of the community who have agreed to take responsibility for maintenance.

Color: Color is probably the most striking design feature of the landscape. It can attract attention to a single plant or a mass of plants. It can create an atmosphere of warmth or a cooling effect.

Two color techniques are generally used in landscape design: background color and accent color. Background color establishes the basic theme of the landscape, providing a backdrop on which to present a harmonious composition. Accent color serves to emphasize certain features in the landscape. Color must be used carefully in the composition of the landscape. Light and cool colors (blues and greens) tend to represent a calm, thoughtful landscape. These colors also appear farther away, or recede from the viewer. Bright and warm colors (reds, yellows, oranges) tend to excite people and may guide the viewer through a landscape. These colors appear nearer to, or to advance toward, the viewer.

Planters

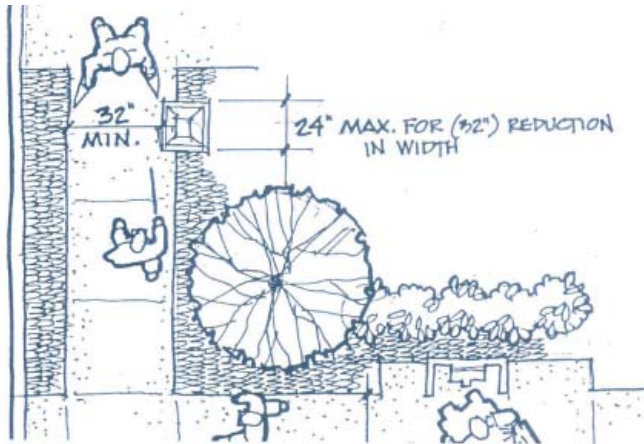

Figure 4-23: Free-standing planters and pinch points (Source: "Accessible Rights-of-Way: A Design Guide," U.S. Architectural and Transportation Barriers Compliance Board [The Access Board], November 1999)

Streetscape planters come in a wide range of styles and sizes, much of which is dictated by the Chicago Landscape Ordinance. When placing planters, it is important to consider accessibility. Federally established accessibility guidelines allow a 32" minimum pinch point for a 2' maximum travel distance. In addition to freestanding planters, light standards and other street amenities must comply with this passage requirement.

Flush Planters: Flush planters have no curb and are placed at the same elevation as the surrounding sidewalk. They can be installed with or without railings, with turf, or with more intense plantings including groundcover, annuals, perennials, and shrubs. When more intense plantings are used, a railing is recommended to protect the plantings. The best example of a flush planter is a typical residential turf parkway. Pedestrian traffic levels must be taken into account when designing flush planters, as they will be used for additional walking space if adequate space is not allocated. In this scenario, railings may be warranted.



Figure 4-24: Flush planter with railing

Curbed Planters: Curbed planters can be poured in place or constructed of precast concrete, granite, or other natural stone. These planters, varying in length, are generally 6"-8" in height and may have a variety of profiles, depending on the design intent of the project. The minimum size for planters, as measured from the inside of the planter curbs, is 4' in width and 8-1/2' in length. Planters can be installed with or without railings. Sidewalk drainage is a key consideration when designing curbed planters. Sidewalks should be graded so that water on the sidewalk, behind the planter, drains in between the planters to the street.



Figure 4-25: Curbed planter

Free-Standing Planters: Free-standing planters come in a variety of sizes and shapes and can be precast concrete or a synthetic material, such as GFRC. They are placed above ground and rest on the sidewalk. Free-standing planters add color and texture in tight areas or where underground conditions, such as utilities and vaults, pre-



Figure 4-26: Hanging basket



Figure 4-27: Orchard Bowl free-standing planter



Figure 4-28: Custom cylindrical free-standing planter

vent in-ground planters from being installed. However, caution must be taken to maintain the accessible route when placing freestanding planters. The City has adopted two standard free-standing planters: the Orchard Bowl planter, as manufactured by Nichols Brothers Stoneworks, or approved equal, in the Stoneworks Tan color finish; and the Custom Cylindrical planter #4238, as manufactured by Wausau Tile, or approved equal, in the Wausau FDX 7008 color finish.

Hanging Baskets: Hanging baskets are specially designed hanging flowerpots. They are constructed of open metal bands and filled with a lightweight planting soil. Baskets can be hung at a height of 12’ from the Chicago Gateway 2000 pole and the 18’ tall Historic Twin Arm pole. Hanging baskets add interest and color to a streetscape and are a way to introduce plant materials when there is no room for trees or planters. Since hanging baskets are costly to install and maintain, they are not recommended outside the central business district without careful study. Although they are purchased and installed by the City, the local chamber of commerce or other community group has the ultimate ongoing maintenance responsibility.

Both freestanding planters and hanging baskets require constant maintenance and require frequent watering. The ability of the community to maintain these elements is a critical factor in the decision to include them on a given project.

Landscaping and Utilities: Before deciding to install planters and trees, a careful check of underground utilities must be made. If large-size utilities are present, such as a 24” or 36” water main or gas lines, they must be relocated if trees or in-ground planters are to be installed above them. This can add significantly to the cost of a project. If the utilities cannot be moved, landscaping cannot be accommodated.

Railings

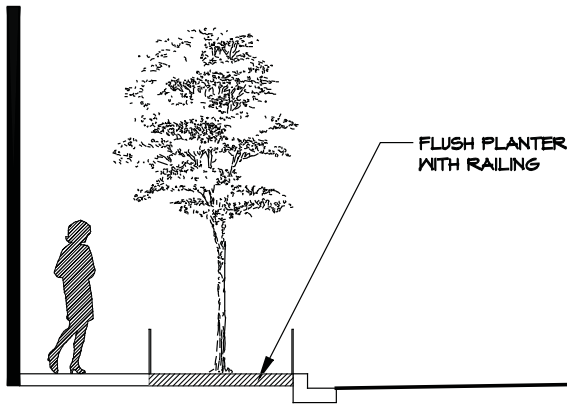

Figure 4-29: Flush planter

Low, ornamental railings add interest and identity to a streetscape, as well as protection from pedestrians and animals, when placed in combination with flush or curbed landscape planters. These railings vary in height from 12"-18". Due to their height and location within the streetscape, railings should not be constructed with pickets extending above the top rail in order to prevent possible snags or injuries.

The City has developed a standard railing for ease of maintenance. There are two standard railing heights: 15" height for installation on top of low planter curbs, and 17-1/2" height for planters without curbs. Both railing types consist of 2" x 2" posts, a 1/2" top and bottom horizontal rail, and 1/2" x 1/2" pickets placed approximately 4" on center. In the taller version, the pickets extend 2-1/2" below the bottom rail. Both railings can accommodate metal panels for community identifiers (see the "Community Identifiers" section of this chapter for more information).



Figure 4-30: Standard railing on planter curb

The panels of pickets between the posts are secured in place with tamper proof bolts. This allows panels to be removed for access to the planter area for tree stump removal and/or tree planting equipment.

In areas where there are existing trees it is often advisable to install a railing without a curb. Unlike a curb, which has a continuous footing, the railing posts have narrow foundations that do not require tree roots to be removed or cut to accommodate railing installation.

Tree Grates



Figure 4-31: Bolted connection of railing panels to post

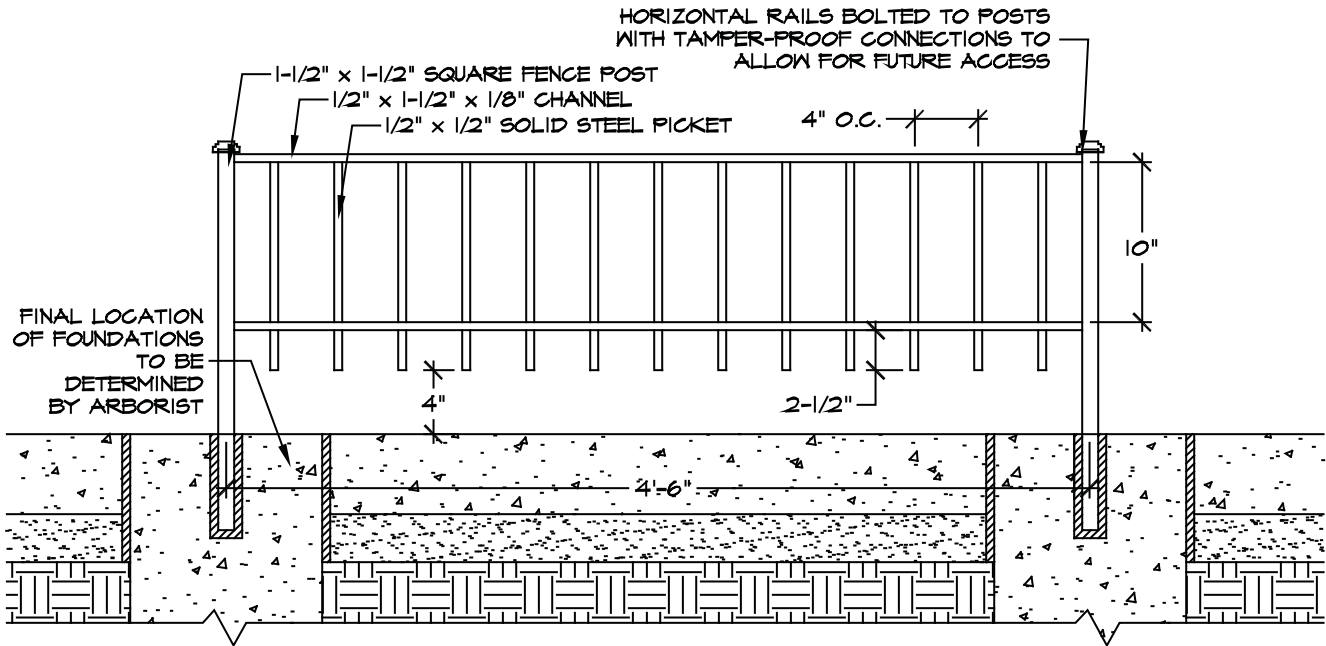

Figure 4-32: Standard railing in flush planter condition

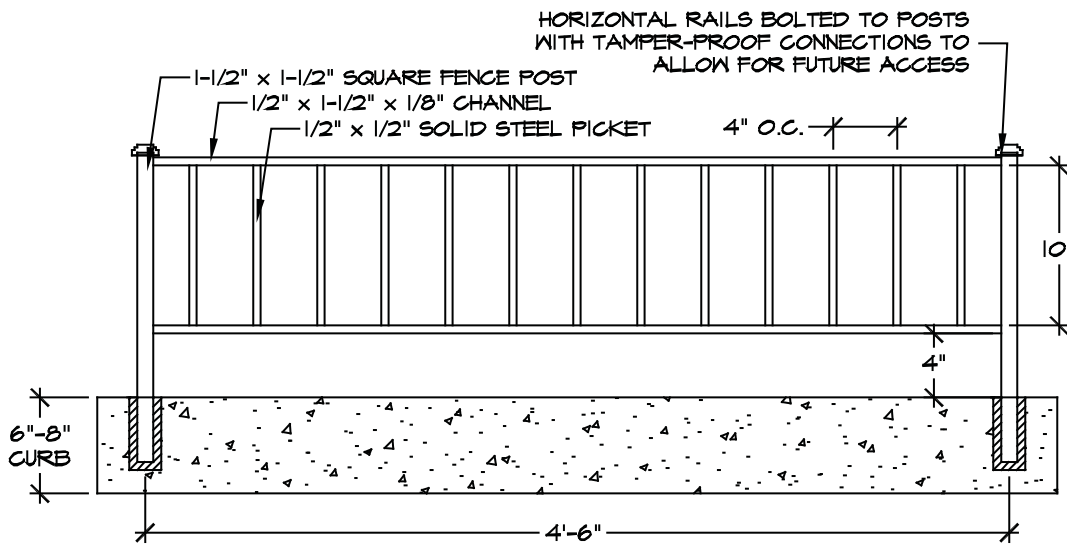

Figure 4-33: Standard railing in planter curb condition



Figure 4-34: Cast iron 4' x 6' tree grate



Figure 4-35: Cast iron 5' x 5' tree grate



Figure 4-36: 5' x 5' tree grate with concrete band

The City of Chicago typically uses cast iron tree grates in the streetscape, however the City is also experimenting with plastic tree grates and water penetrable composite rubber “grates.” Tree grate openings must comply with ADA accessibility guidelines. This means that the slots of the tree grate must not be more than 3/8” wide.

Cast Iron Tree Grates: Cast or ductile iron tree grates have been used throughout the City of Chicago for many years. Iron tree grates have the benefits of strength, durability, stability, low maintenance, non-flammability, and the ability to be cast in varying thicknesses and patterns. Manufacturers have standard “off-the-shelf” patterns that can be purchased by contractors and still satisfy CDOT requirements. Iron tree grates must have breakout rings or removable bolted tree rings cast into the grate. This allows the center of the tree grate to literally be broken out or removed to accommodate the growing tree trunk.

The City of Chicago has adopted two standard expandable tree grates: a 5' x 5' grate, Model R-8713, and a 4' x 6' grate, Model R-8814-A, as manufactured by Neenah Foundry, or approved equal. These grates are 1-1/2” thick and the opening for the tree is 16” in diameter minimum. The frame is a 1-1/4” x 1-1/4” x 1/4” steel frame and surrounds the entire perimeter of the tree pit. Anchor tabs allow for installation into the surrounding concrete. The Streetscape and Urban Design Program treats tree grates with linseed oil prior to installation. This alleviates the initial rusty appearance of the untreated metal and creates the dark brown color characteristic of weathered cast iron.

Plastic Tree Grates: Plastic tree grates are an alternative to cast iron grates. Benefits of using plastic tree grates include lower cost and the environmental benefit of using recycled plastic. The City of Chicago is experimenting with the use of recycled plastic tree grates to determine their best use.

SIDEWALK PAVEMENT



Figure 4-37: Special finish sidewalk

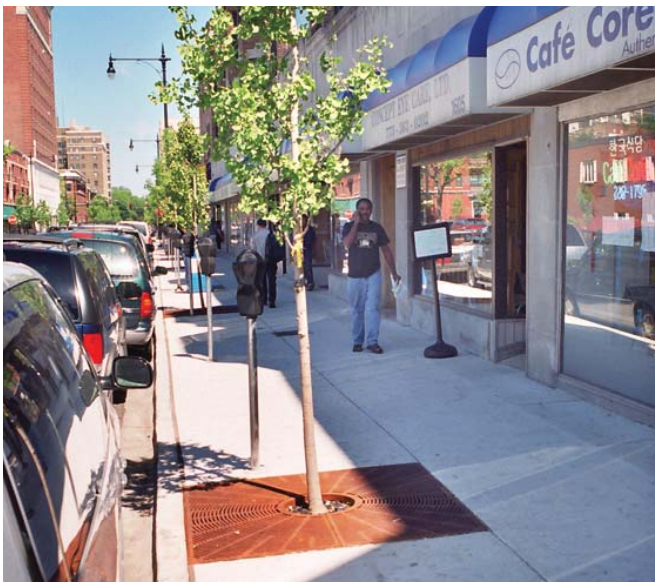

Figure 4-38: Standard sidewalk



Figure 4-39: Standard sidewalk with unit paver border

Pavements, especially in urban areas, form the floor of the outdoor environment in which people live, work, and play everyday. The ground plane treatment is one of the most important elements for setting the initial mood of the space. A space covered in grass will feel much different than the same space covered in concrete. Even if the outdoor area is accented with trees, lights, benches, people, and other urban space elements, the ground plane sets the tone for how the space is to be used and how it feels to the user.

For the most part, the sidewalks in the City of Chicago are constructed with concrete, although a number of areas have concrete walks accented with the addition of other materials, such as pavers.

Monolithic Sidewalks

Most sidewalks are “monolithic.” This means that the pavement is constructed with one material, most typically Portland Cement Concrete (P.C.C.).

The typical P.C.C. sidewalk constructed in the City has the following characteristics:

- Thickness: 5”
- Strength: minimum 3,500 pounds per square inch
- Not reinforced with wire mesh or rebars
- Broom finished top surface

This type of sidewalk is easy to install and long lasting when installed correctly. Repair of the sidewalk is easily accomplished when properly done.

There are a number of variations to P.C.C. sidewalks.

Scored Concrete: Typically, concrete sur-



Figure 4-40: Standard scored concrete



Figure 4-41: Window pane finish concrete



Figure 4-42: Stamped concrete medallion and texture

faces are scored into squares or rectangles in order to control cracking in the concrete slabs. Additional scoring can be added to further break up the concrete surface and to add visual interest. This additional scoring can be either hand tooled during initial installation or saw cut after curing of the concrete. Special attention should be paid to concrete scoring at certain streetscape elements, especially tree grates, planters, and light poles.

Window Panes: Scoring can be combined with wide tooling of the surface to create a “window pane” effect. This must be done during the final finishing of the concrete. After the concrete surface has been broom finished, the scoring is created using a wide concrete tool that creates a smooth surface on both sides of the score joint. This smooth surface can vary from 2”-3” wide and the resulting surface has a higher level of visual interest.

Stamped Concrete: Stamped concrete was developed to impress a design into a monolithic concrete surface. There are numerous patterns available: most are achieved by pressing a metal or rubber master pattern into the freshly poured concrete surface. Colorings can be added, either integral to the concrete or during the curing process.

Stamped concrete can be made to look like any surface including brick, cobbles, flagstone, and boardwalks. The Streetscape and Urban Design Program recommends the use of broad, stone-textured patterns that are then scored. This technique has a natural look and is relatively easy to produce and repair.

Concrete Detailing and Streetscape

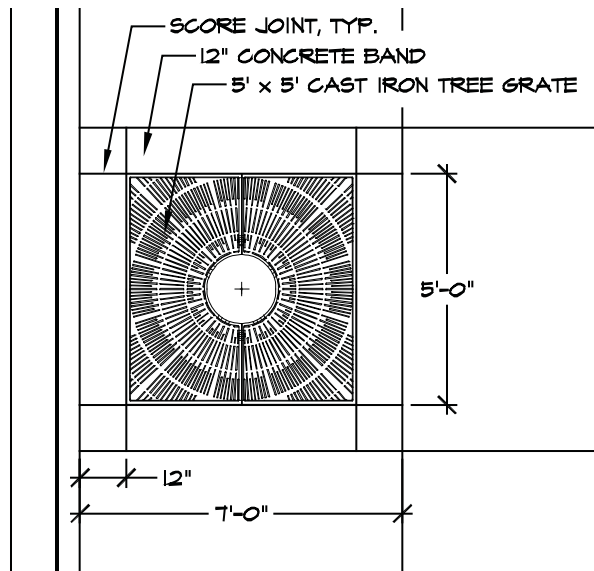

Figure 4-43: Typical tree grate concrete scoring

Elements

To avoid cracking and increase the longevity of concrete walks, it is important to pay close attention to joint detailing. Each streetscape element poses a different circumstance that must be addressed. The Streetscape and Urban Design Program recommends that a 12" concrete band be installed adjacent to tree grates, whenever possible. These bands should be scored at the corners, as shown in Figure 4-43. Curbed concrete planters should have an expansion joint between the planter curb and the surrounding concrete walk. Similarly, light poles should have an expansion joint between the light pole footing and the surrounding concrete walk.



Figure 4-44: Expansion joint at light pole footing



Figure 4-45: Expansion joint at planter curb



Figure 4-46: Holland Stone unit pavers

Unit Paver Sidewalks

In contrast to monolithic sidewalks, unit paver sidewalks are created using small paving units that form the surface of the sidewalk. Unit pavers have been in use in Chicago since the City was constructed. The old, original brick streets that often underlay newer asphalt surfaces were constructed with unit pavers. The City of Chicago streetscape standards do not advocate the use of pavers for the entire width of the sidewalk, but instead as a decorative element to accent or enhance particular aspects of the streetscape. Unit pavers are made from a number of materials, including concrete, clay, and stone, and are highly variable in color, finish, and texture. Unit pavers are not appropriate for all streetscape projects and both maintenance and budgetary constraints must be considered when determining their appropriateness.

Concrete Unit Pavers: These pavers are fabricated from highly compressed, specialized concrete mixes. High quality concrete unit pavers have the following characteristics:

- They have very high strength, often in the range of 8,000 pounds per square inch.
- Their absorption rates are low (generally in the four to five percent range) to help prevent spalling.
- They have UV resistant, integral color throughout the paver, however concrete unit pavers will tend to fade over time. Depending on the quality and color of the paver, this may take from three to five years of exposure to the sun.

The City of Chicago standard for concrete unit pavers is the Holland Stone paver (4" x 8" x 2-3/8") or Double Holland paver (8" x 8" x 2-3/8") manufactured by Unilock, or approved equal. Pavers are chamfered and have lugs. The color standard is either a buff/brown blend or a charcoal/natural blend.



Figure 4-47: Clay unit pavers accent this seating area

Clay Unit Pavers: These pavers are fabricated from clay that is fired at extremely high temperatures. However, unlike typical building bricks, clay unit pavers are solid and must meet much higher strength requirements due to their exposure to weathering, water, and salt. High quality clay unit pavers have the following characteristics:

- They have extremely high strength, often in the range of 10,000-12,000 pounds per square inch.
- Their absorption rates are low (generally in the four to five percent range) to help prevent spalling.
- Because the paver is a fired product, the color of the paver will not change over time.



Figure 4-48: Clay unit pavers border this sidewalk

The City of Chicago standard for clay unit pavers is the English Edge (chamfered) 4" x 8" x 2-1/4" paver, as manufactured by the Pine Hall Brick Company, or approved equal. The standard color blend is 75 percent Ironspot, 15 percent Dark, and 10 percent Red.



Figure 4-49: Special finish pavers: Unigranite



Figure 4-50: Special finish pavers: Brussels Block

Special Finish Pavers: There are a number of manufacturers of high quality, special finish pavers. These pavers generally are fabricated in a variety of sizes, and have highly variable and customizable surface textures and colors. Due to their larger size they are appropriate for larger sidewalk sections, especially plazas and special interest areas. Special finish pavers can also represent natural stone products such as marble, granite, or other natural local or imported stones.

The City of Chicago has selected the following two special finish pavers as the standard:

- The Unilock Unigranite Paver in either the small square (4" x 4" x 2-3/4"), or the large square (6" x 6" x 2-3/4") size paver, or approved equal. The finish can be either split face to resemble granite, or saw-cut for a smooth surface finish. The slate, rose, and black standard color selections are all acceptable.
- The Unilock Brussels Block tumbled paver in either the standard (7" x 8-1/4" x 2-3/4"), half (7" x 4-1/8" x 2-3/4") or quarter (3.3" x 4" x 2-3/4") stone, or approved equal. The standard color is the Limestone/Sandstone/Bluestone color combination blend.



Figure 4-51: Brussels Block unit pavers and tree grates



Figure 4-52: Brussels Block unit pavers in Giddings Plaza

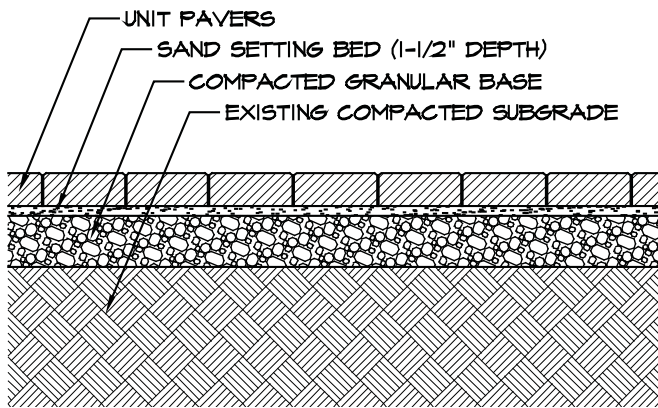

Figure 4-53: Flexible base system

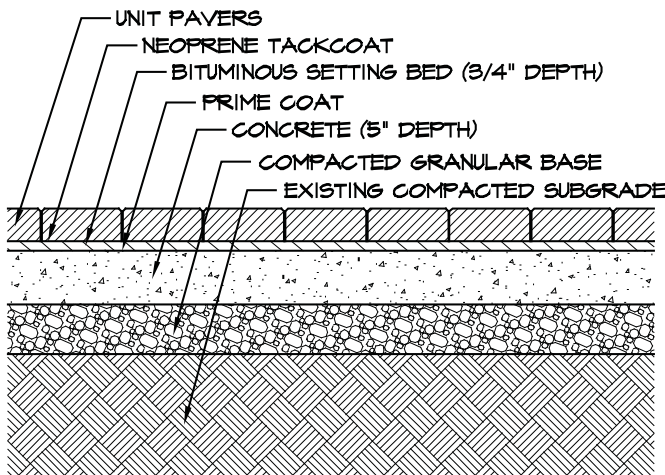

Figure 4-54: Rigid base system

Unit Pavement Construction

Unit pavements are constructed in one of two ways: flexible base or rigid base system.

Flexible Base System: In this system, unit pavers are placed on a sand setting bed that is installed on a compacted stone base course. This system is used in plazas and where established tree roots would be damaged by a rigid base system. When installed around trees, a non-limestone compacted granular base should be used. This system has the following characteristics.

- Initial installation is comparatively easy.
- Repairs to subsurface utility systems are easier to access, however repair of the unit paver surface is difficult to achieve to the original grade. Careful attention must be made to meet original compaction levels to prevent uneven settling.
- Finished surface of pavement is subject to settling as the subgrade settles. Settlement may occur adjacent to fixed objects (lights, etc.) and adjacent monolithic pavements (sidewalks) and curbing.

Rigid Base System:

In this system, the unit pavers are placed on a bituminous bed that is installed on a concrete slab base course. The concrete is installed similar to any sidewalk slab with a stone base course over a compacted subgrade. This system is typically used in sidewalks and crosswalks. The characteristics of this system are as follows:

- This is a comparatively more difficult system to initially install and typically more costly.
- This system is much more resistant to settlement since the concrete underlayment bridges over areas of subgrade that are not fully compacted.
- This system is outstanding for areas subject to vehicular traffic.



Figure 4-55: Roadway striping



Figure 4-56: Roadway and crosswalk striping

ROADWAY PAVEMENT

The City of Chicago surfaces all of its roads with asphalt. Typically a 1-1/2" base course is installed with a 1-1/2" top coat. Viaducts and bus pads are the only exception: a concrete surface is installed in these cases. The CDOT Bureau of Streets or the CDOT Bureau of Highways Arterial Resurfacing Program usually performs road resurfacing.

Cook County or the Illinois Department of Transportation owns some of the roads in Chicago. In these cases, the owner agency often performs the resurfacing. Proposed alterations to streets owned by these agencies, such as street width or traffic changes, must be approved by the owner agency.

Striping

The City of Chicago has standards for striping driving lanes, parking spaces, crosswalks, stop bars, and bicycle lanes. The Streetscape and Urban Design Program or the CDOT Bureau of Signs and Markings performs striping. While a project is under construction, temporary painted marking may be used. However, final markings are thermoplastic and are more permanent and long lasting.

Crosswalks



Figure 4-57: Stamped asphalt crosswalk



Figure 4-58: Stamped asphalt crosswalk

As was discussed in Chapter Three, crosswalks are the legal pedestrian crossings for City streets. The Streetscape and Urban Design Program uses 1' wide white stripes to delineate crosswalks. When appropriate, the installation of stamped asphalt or pavers may be used to enhance the crosswalk. Both have maintenance considerations that must be studied to determine appropriateness of use.

Stamped Asphalt

Stamped asphalt is used in the vehicle and parking zones to delineate special areas and to give character to the streetscape. The Streetscape and Urban Design Program uses it to highlight crosswalks when appropriate. Stamped asphalt must be heated, re-stamped, and re-colored periodically to maintain its effectiveness. Depending on the amount of traffic on a street, the asphalt may need to be re-colored every year or every other year.

The Streetscape and Urban Design Program standard for stamped crosswalks is to install both texture and color for the entire width and length of the crosswalk between the white stripes. Any of the standard colors or patterns as manufactured by Street Print, or approved equal, can be used. However, the Streetscape and Urban Design Program recommends the color be terra cotta or brick since darker colors may be difficult to see against the adjacent black asphalt street surface.

Curb and Gutter



Figure 4-59: Typical curb and gutter

Curbs define the edge of the sidewalk where it meets the street and act as a barrier to prevent vehicular traffic from riding up onto the sidewalk. The gutter is located in the street, adjacent to the curb, and forms the edge of the roadway pavement. The gutter collects water run-off from the street and channels it into the appropriate drainage structures, which are located along its length. The City of Chicago installs cast-in-place curb and gutter. The typical curb is 18" deep and 6" wide and tapers into an integral 12" x 12" gutter.

Curb Ramps



Figure 4-60: Typical curb ramp

Curb ramps provide a connection from the sidewalk to the street for people in wheelchairs, people pushing strollers, children on bicycles, and delivery services. Curb ramps are required at all intersections and crosswalks, including mid-block crossings, and should align with the center of the crosswalks.

A typical curb ramp consists of the ramp, side flares, approach and a landing. The slope of the ramp must not exceed 8.33 percent, or 1" rise per 1' length. The flares must not exceed 10 percent, although 8.33 percent is preferred whenever possible. The cross slope must not be greater than 2 percent. The preferred width of a curb ramp in Chicago is 6' and the minimum width is 4', not including the width of the flared sides.

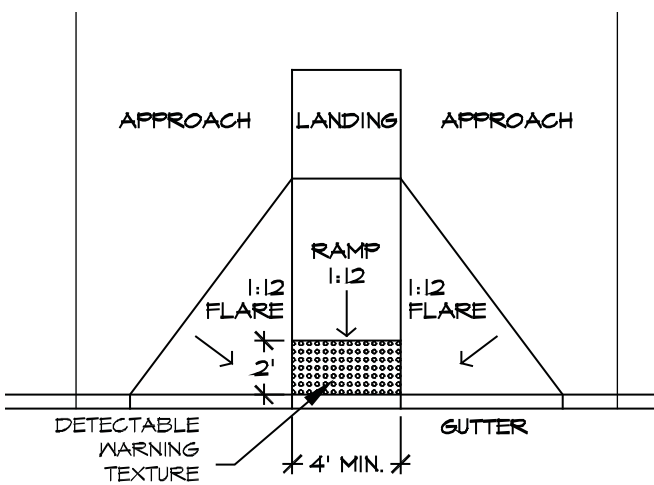

Figure 4-61: Typical curb ramp components

There are two curb ramp types generally used in the City of Chicago:

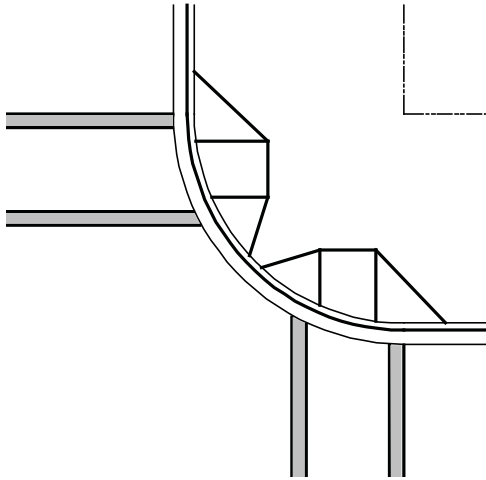

Figure 4-62: Perpendicular curbside ramps

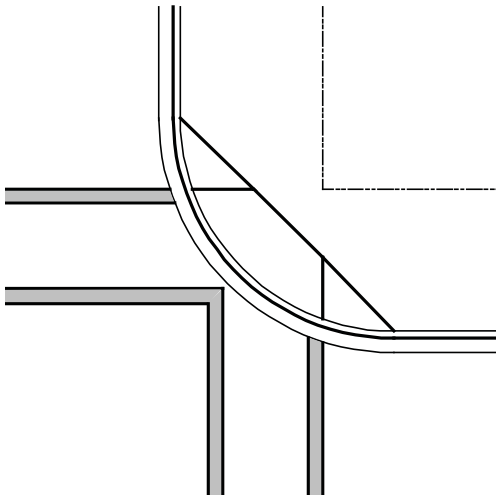

Figure 4-63: Diagonal curbside ramp

- **Perpendicular ramps** run perpendicular to the curb face allowing the ramp to be parallel to the marked crosswalk.
- **Diagonal ramps** are simply one perpendicular ramp placed at the apex of the corner. These ramps should only be installed when conditions are such that two separate ramps are not practical and one wider ramp leads to a safer condition. It is important that the ramp be designed wide enough to allow pedestrians to exit into the crosswalks and not into the intersection.

Detectable warning surfaces should be applied to all ramps to indicate the interface with the street. Currently, the City of Chicago follows the Illinois Department of Transportation standard for detectable warning surface.

STREET FURNITURE



Figure 4-64: Diagonal curbside ramp



Figure 4-65: Victor Stanley Ribbon Bench (RB-28)



Figure 4-66: Victor Stanley Ornamental Bench (CR-10)



Figure 4-67: Victor Stanley trash receptacle (S-42)

The Streetscape and Urban Design Program has chosen a standard palette of furniture for ease of maintenance and durability.

Benches

The City has chosen two types of steel benches for use in the public way: the Victor Stanley Ribbon Bench (RB-28) and the Victor Stanley Ornamental Bench (CR-10), or approved equal. These benches were selected for their durability under the most extreme environmental conditions and their vandal-proof protection against destruction and defacing. Both bench types are provided with a center arm. Black is the standard color.

Benches are usually placed at bus stops, mid-block, corner intersections, or other locations within the streetscape where people tend to gather. The local community generally verifies actual locations during the design phase.

Trash Receptacles

The City has chosen the Victor-Stanley Steelsites (S-42) container, or approved equal, in the color black as the standard waste receptacle for use in the public way. As with the benches, this waste receptacle was selected for its durability under the most extreme environmental conditions, and its vandal-proof protection against destruction and defacing. Waste receptacles are usually placed two per block, on opposite corners at intersections. The local community generally verifies actual locations during the design phase of the project.

Bicycle Racks



Figure 4-68: Bike rack

The Bicycle Rack Program is managed by the CDOT Bureau of Traffic, and provides for the installation of bike racks throughout the City. Typically, during the design of a streetscape, the Bike Rack Program reviews plans and verifies locations of bike racks in commercial districts near critical masses of retail shopping. Depending on the other street furniture proposed in the streetscape, bike racks are located with an average frequency of two per block

The Bike Rack Program also receives independent requests for placement of bike racks. These requests are incorporated into the streetscape design plans when they fall within the limits of a streetscape project. The Bicycle Program installs bike racks in the selected locations after the streetscape project is complete.

The standard style of bike rack is a square tube, black powder-coat finished, U-shaped rack bolted to the sidewalk. This type of bike rack allows several bicycles to be locked at once without being damaged.



Figure 4-69: Steel pipe bollards

Bollards

The Streetscape and Urban Design Program has chosen two bollards for use in the public way. The more conservative bollard; often used to protect gateway identifiers, above-ground irrigation equipment, and other streetscape elements; is a 6'-8' length steel pipe filled with concrete. The above ground portion (usually 30"-36") is covered with a black low density polythelene sleeve and cap. The more decorative bollard is a precast concrete bollard, as manufactured by Wausau Tile, Inc., or approved equal. The bollard is Terra Form Series model TF 6092 Lapaz Bollard in the weatherstone buff color.

COMMUNITY IDENTIFIERS



Figure 4-70: Precast concrete bollard



Figure 4-71: North Halsted Street community identifier

Community identifiers are sculptural elements within a streetscape that seek to bring a unique identity to a neighborhood commercial area. This character can be drawn from many different sources: cultural ethnicity, architectural styles or elements, special cultural or historic institutions, or the general historical background of a neighborhood.

Since these elements can be expensive and



Figure 4-72: Banners and hanging baskets



Figure 4-73: Howard Street community identifier



Figure 4-74: Humboldt Park neighborhood identifier



Figure 4-75: Greektown neighborhood identifier

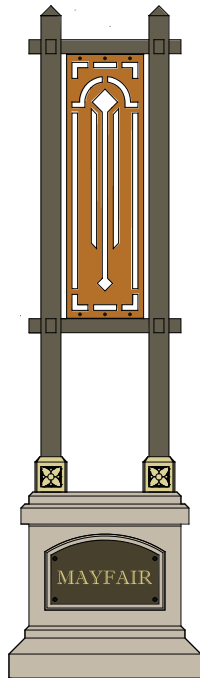

Figure 4-76: Mayfair neighborhood identifier

are unique to each community, separate funding must be identified in order for community identifiers to be included in a streetscape project.

Via community meetings and design charrettes, a symbol or idea may be developed to be used repeatedly in a variety of forms throughout a neighborhood, such as:

- Large, single-use elements that act as gateways, either in the street or on the sidewalk
- Smaller, repetitive elements such as fabric banners or permanent pole identifiers
- Pavement medallions
- Pavement treatments along the streetscape
- Modifications to standard streetscape elements to include identity elements, such as special medallions placed on railings

Identifier Elements

The following represent some of the elements that may be used as community identifiers.

“Gateways” and Area Markers: An area marker or gateway is generally a large sculptural element placed either at the end of a streetscape or along a streetscape. These elements serve the purpose of marking the entranceways and throughways into the commercial/retail district. A variety of structures have been used for existing gateways in the City of Chicago, including an interior lit “lighthouse” with bronze community name plaques, large steel vertical elements with the name of the area laser cut into the steel, and large sculptural archways with and without community labels identifying the community area.

Kiosks: The purpose of a kiosk is to present information about both the commercial/retail area, as well as local events taking



Figure 4-77: Hegewisch kiosk



Figure 4-78: LaSalle Street kiosk

place within the area. The kiosk may present permanent information or include a Plexiglas case that allows change-out of information. The Plexiglas case is only installed when a community has identified a group, typically the local chamber of commerce, to maintain it and oversee the information to be displayed in the case.

The Streetscape and Urban Design program has two standard styles and structures for neighborhood information kiosks: the “Hegewisch” kiosk and the “LaSalle Street” kiosk. The Hegewisch kiosk is a double-sided steel structure that presents information in a Plexiglas case. The LaSalle Street kiosk is also a flat double-sided kiosk, but has permanent signage or directional information.

Banners and Pole Identifiers: Banners are rectangular fabric signs (30” x 8’) that are



Figure 4-79: 47th Street pole identifier

mounted in flag fashion on one or two sides of the light standards along a streetscape. The community installs the banners once it obtains a permit from the Chicago Bureau of Electricity. This permit must state the install and remove dates.

Pole identifiers, unlike banners, are more permanent and are generally manufactured from metal. The Chicago Gateway 2000 light poles can easily be fitted to accommodate most pole identifiers and banners. Although banners can be changed seasonally or for special events, both pole identifiers and banners can represent the unique character of a community group, its individual identities, or commercial members.

Sidewalk Medallions: Pavement markers,



Figure 4-80: Hegewisch neighborhood pole identifier



Figure 4-82: Pilsen neighborhood pole identifier and Edgebrook neighborhood banner



Figure 4-81: Grand Avenue pole identifier



Figure 4-83: Andersonville pavement medallion



Figure 4-84: Belmont/Central pavement medallion

or sidewalk medallions, are ornamental emblems that are set or stamped into sidewalks along a streetscape, usually at intersection corners. These medallions are typically precast concrete and can be logos or other representations of community identity.

Public Art: Public art is another way that communities can distinguish themselves in the streetscape. The Percent for Art Ordinance and its amendments stipulate that a percentage of construction and renovation costs for municipal buildings be set aside for the acquisition of artwork for use in conjunction with the buildings. At least half of the commissions are to be awarded to Chicago area artists. In certain cases, funds from this program may be available for streetscape projects.

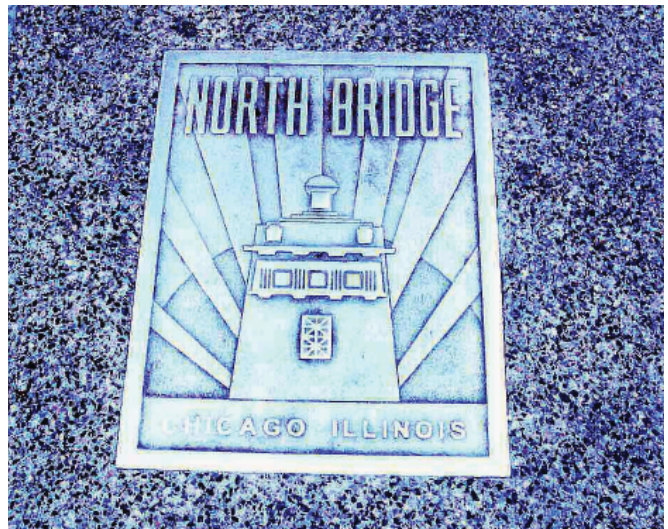

Figure 4-85: North Bridge pavement medallion



Figure 4-86: Lincoln Square community identifier



Figure 4-87: Old Town community identifier

Construction and Maintenance

The constructability of a design as well as maintenance concerns must be at the forefront of the design process for identifier elements, whether large or small. As ideas for identifiers grow in size and complexity, there is often a direct correlation to increased costs for manufacturing, installing, and maintaining these items. Although identifiers are often dramatic statements, if they are not designed, located, and constructed properly they can become more of a liability than an asset to the community. Whenever feasible, gateway identifiers should be protected with bollards.

Often a community desires to have lighting incorporated into the design of their community identifier. This requires careful design and consideration of maintenance. All designs must be approved by the Chicago Bureau of Electricity and must use standard components for ease of maintenance.

Design Standards

Depending on the type of identifier element, proper design standards must be maintained to ensure proper use, maintenance, and safety. For example, placement must not impede the accessible route. Items that protrude into a circulation route may be hazardous for pedestrians who are blind. Projections are detectable by a cane if the leading edge is at or below 27". Headroom heights must also be considered: 80" minimum is recommended. (Source: "Accessible Rights-of-Way: A Design Guide," U.S. Architectural and Transportation Barriers Compliance Board, "The Access Board," November, 1999).

When space is tight, communities may wish to place identifier elements on private property. Although the City will help with these efforts, the Streetscape and Urban Design Program will not pay for or install them. Gateways over the street may be another option, however these are strictly limited and are only considered for streets with low traffic movement and no truck traffic.



Figure 4-88: Single head parking meters



Figure 4-89: Double head parking meters

PARKING

As mentioned in the previous chapter, design of the parking zone must address a variety of considerations and includes both parking spaces and meters.

Parking Meters

The Chicago Department of Revenue is in charge of installing parking meters. Once the streetscape project is complete, CDOT coordinates with the Chicago Department of Revenue to ensure that the type of meters chosen by the community are installed.

Either double-head meters or single head meters can be used in the streetscape. Single-head meters are typically placed at the front of the stall. Double-head meters are placed between the two parking spaces for which they are designated and are encouraged by the Streetscape and Urban Design Program since they reduce clutter in the sidewalk zone. All parking meter heads are black while the poles are galvanized steel pipes. However, in the central business district meter poles may have a black finish.

In order for double-head meters to be installed by the Department of Revenue, the local alderman must write a letter to the Department of Revenue requesting the installation.

Pay Boxes for Street Parking

The Chicago Department of Revenue is experimenting with pay boxes as an alternative to parking meters. These boxes are placed on the sidewalk, one on each end of the block, on both sides of the street. The pay box system requires individuals to walk to the pay box, pay for parking time, and then return to their car to place the receipt in the windshield. The feasibility of this system is still under investigation by the Chicago Department of Revenue. Pay boxes are not currently installed under the Streetscape and Urban Design Program.



Figure 4-90: Diagonal parking with planter

Diagonal Parking

When designing a streetscape, if parking spaces are at a premium and the community requests it, diagonal parking may be added to side streets between the arterial street and the alley. In order for diagonal parking to be installed, all designs must be reviewed and approved by the CDOT Bureau of Traffic and several criteria must be taken into account, including:

- Width of the right-of-way
- Traffic direction on the street
- Presence of utilities or mature trees
- Adjacent land uses

The parkway is usually removed for the installation of diagonal parking, thereby eliminating space for trees or planters. If there are no setbacks or site line conflicts, island planters with trees can be located at the ends of the parking stalls at the bump-outs that help define the parking area. For every side street, at least one parking stall must be universally accessible.



Figure 4-91: Traffic control devices, signage, and identifiers on Howard Street

TRAFFIC CONTROL DEVICES

The CDOT Bureau of Traffic and the Chicago Bureau of Electricity are in charge of installing traffic control devices. Traffic signal installation is not funded by the Streetscape and Urban Design Program but is coordinated with and, when appropriate, added to the streetscape construction project with separate funding.

When appropriate, existing traffic signal poles are painted black. If traffic poles also have an existing street light fixture, the mast-arm and fixture are replaced with a Chicago Gateway 2000 mast-arm and fixture, if feasible.

SIGNAGE

The CDOT Bureau of Signs and Markings governs regulatory signage. Signs are surveyed and then removed at the start of streetscape construction. They are replaced with temporary signs as required during construction. When construction is complete, the CDOT Bureau of Signs and Markings reinstalls all necessary signage. In the City's ongoing effort to reduce clutter on the sidewalk, the amount of signage may be reduced with the sign consolidation program.



Figure 4-92: Traffic control devices and signage



Figure 4-93: Traffic control devices, banners, and median planter on North Avenue



Figure 4-94: Traffic control devices, signage and neighborhood gateway identifier on Wells Street



**COMBINING STREETSCAPE
ELEMENTS**





Figure 5-1: Oak Street



Figure 5-2: Devon Avenue



Figure 5-3: Howard Street

COMBINING STREETScape ELEMENTS

There are nearly limitless potential streetscape concepts given the various options of elements and ways of balancing the element line. It is the streetscape designer’s challenge to create concept alternatives that follow federal accessibility requirements, comply with the Chicago Landscape Ordinance, and meet the goals of the community and the City.

This chapter discusses considerations for combining streetscape elements and presents a sampling of the many possible streetscape concepts that may be developed.

STEPS TO A SUCCESSFUL PROJECT

As we have discussed throughout this guide, a successful streetscape project must achieve several goals. In addition to meeting all required codes and standards, it must service its users: vehicles, pedestrians, business owners, and residents. The ultimate goal of the streetscape is to improve the livability of the City for its citizens and visitors. When determining the appropriate combination of elements for any project, beauty and function must go hand-in-hand. The balance between these two forces must be kept at the forefront of thought to achieve a successful project.

Beautification and Livability

Step one is to create a “wish list” of amenities the community would like to see in the project. These must then be balanced against the issues discussed throughout this guide, as well as the existing conditions of the streetscape site.



Figure 5-4: Consider right-of-way width



Figure 5-5: Extensive plantings require extensive community maintenance.



Figure 5-6: While they add a unique flair to a streetscape, custom elements are difficult to replace.

Right-of-Way Width

The portion of the right-of-way dedicated to the sidewalk zone, versus the parking zone and the vehicular zone, is the second critical consideration. As discussed in Chapter Two, these widths and their relationships to each other impact the combination of elements that can be used on a project.

Budget and Maintenance

Budget and long term maintenance are also critical considerations. While almost anything can be done with unlimited funds, budget constraints make it important to prioritize your wish list of amenities and balance that against infrastructure needs.

Even if an element is desired and feasible within the existing conditions and budget constraints, it may not be maintainable. This consideration is paramount because without successful maintenance, in the long run, all the hard work of the community and the City will be for naught.

While the City is responsible for the maintenance of certain items, the community also plays a critical maintenance role. It is important to consider the affordability of the maintenance required for desired streetscape items, as well as to clarify who will be responsible for maintenance, before making the final selection of streetscape elements.



Figure 5-7: Narrow sidewalk condition



Figure 5-8: Narrow sidewalk condition with flush plantings on private property



Figure 5-9: Narrow sidewalk condition with landscaping on private property

STREETScape COMBINATIONS

The following examples illustrate streetscape element combinations in a variety of right-of-way conditions to help spur your design process.

Sidewalks 9' Wide or Less

This narrow sidewalk zone creates challenges for developing streetscape improvements beyond pavement replacement and installation of new light fixtures. Although the narrow sidewalk condition prevents the use of trees, landscape may be added to the streetscape by using hanging baskets on light poles and free-standing planters, either on the sidewalk or within the window spaces at the building fronts. Care must be taken not to impede pedestrian flow in these narrow streetscape conditions.

In certain instances, communities can work with private property owners to add landscaping that blends with an overall streetscape plan. A good example of this is along parking lots since landscaping screening and fencing are required per the Chicago Landscape Ordinance. The required buffer zones can be used to provide the effect of streetscape landscape. This strategy is especially important for streetscapes in the narrow sidewalk category that may not otherwise incorporate trees and shrubs.

The following patterns illustrate several options that could be used in this narrow sidewalk condition.

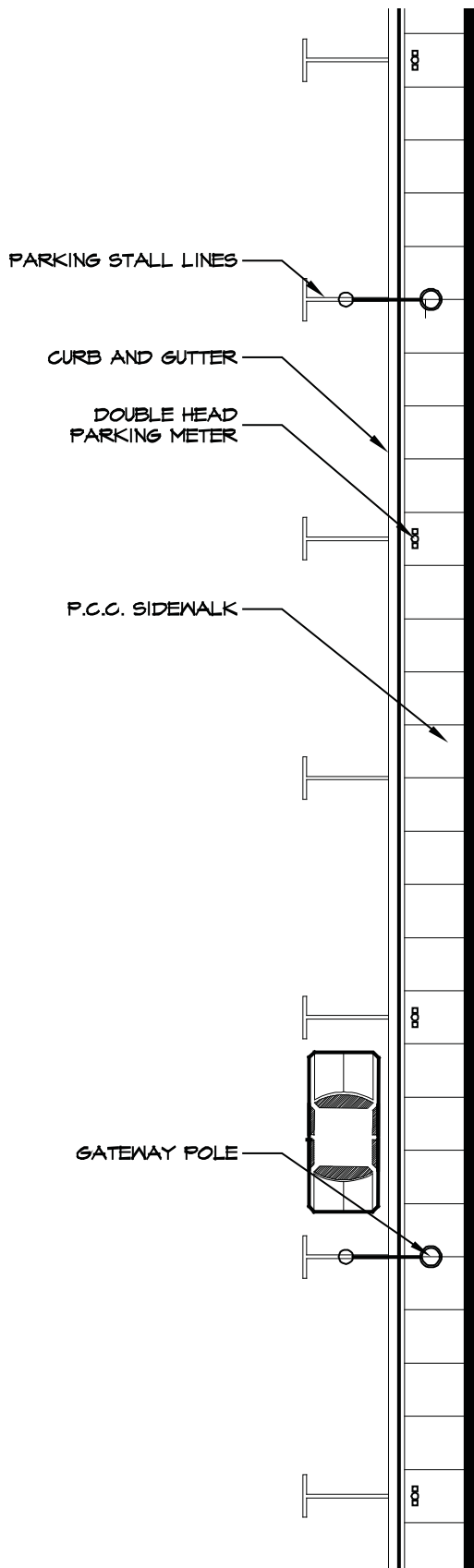

Concept A-1

Sidewalk Width: Less than 9' Wide

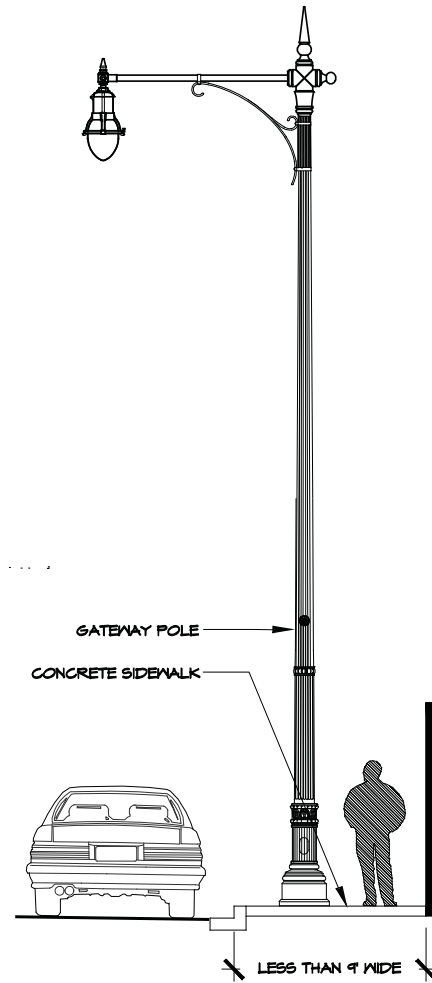

Figure 5-11: Section of Concept A-1

This pattern includes the following elements:

- Chicago Gateway 2000 poles to illuminate the sidewalk and street pavements
- Double-head parking meters
- Concrete sidewalks

This is the most basic streetscape design.

Figure 5-10: Plan of Concept A-1

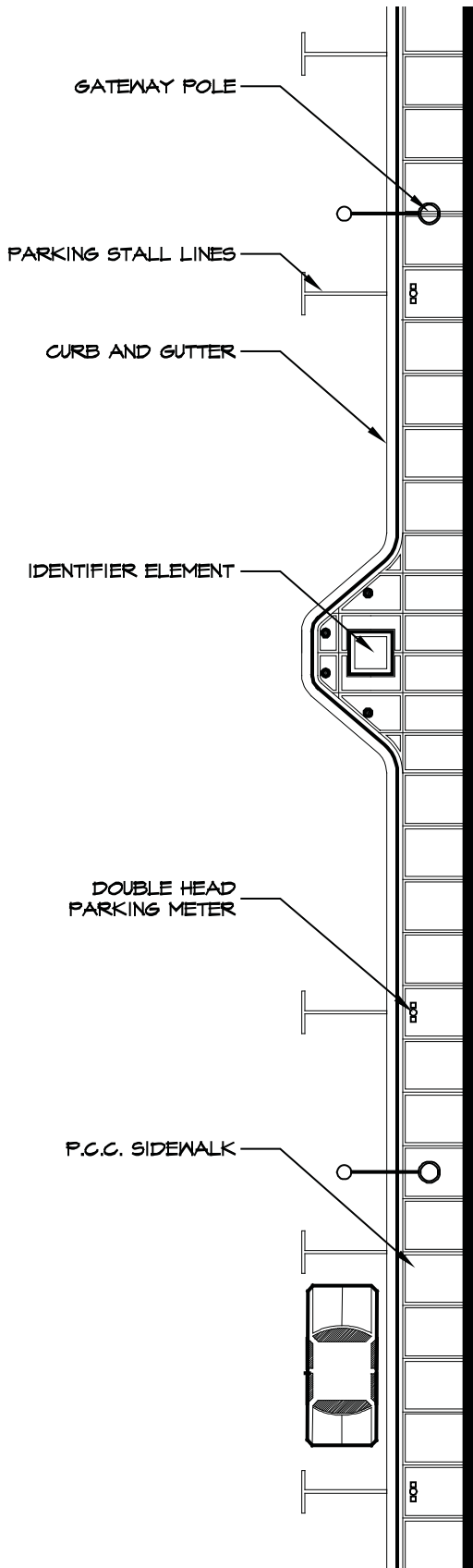

Figure 5-12: Plan of Concept A-2

Concept A-2

Sidewalk Width: Less than 9' Wide

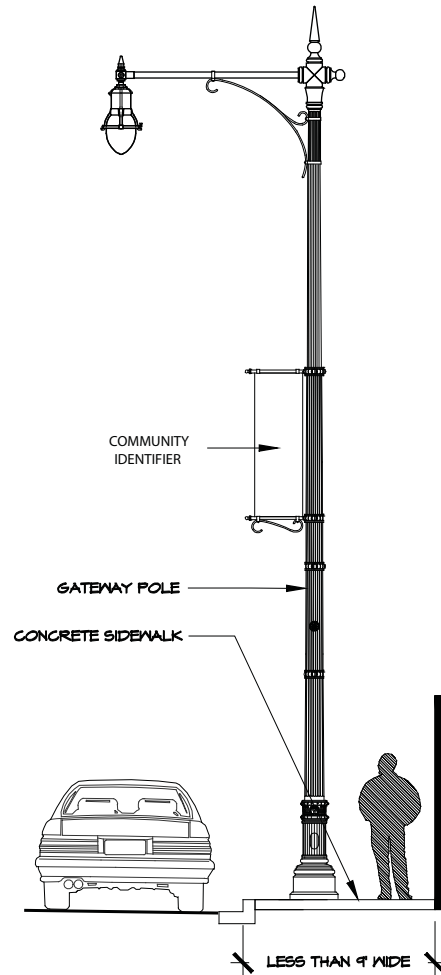

Figure 5-13: Section of Concept A-2

This pattern builds on Concept A-1. A mid-block curb extension replaces one parking space to provide an opportunity for a vertical community identifier. In addition, permanent community identifier panels are added to the light poles. The concrete has also been enhanced with a “window pane” finish to give the paving visual interest.

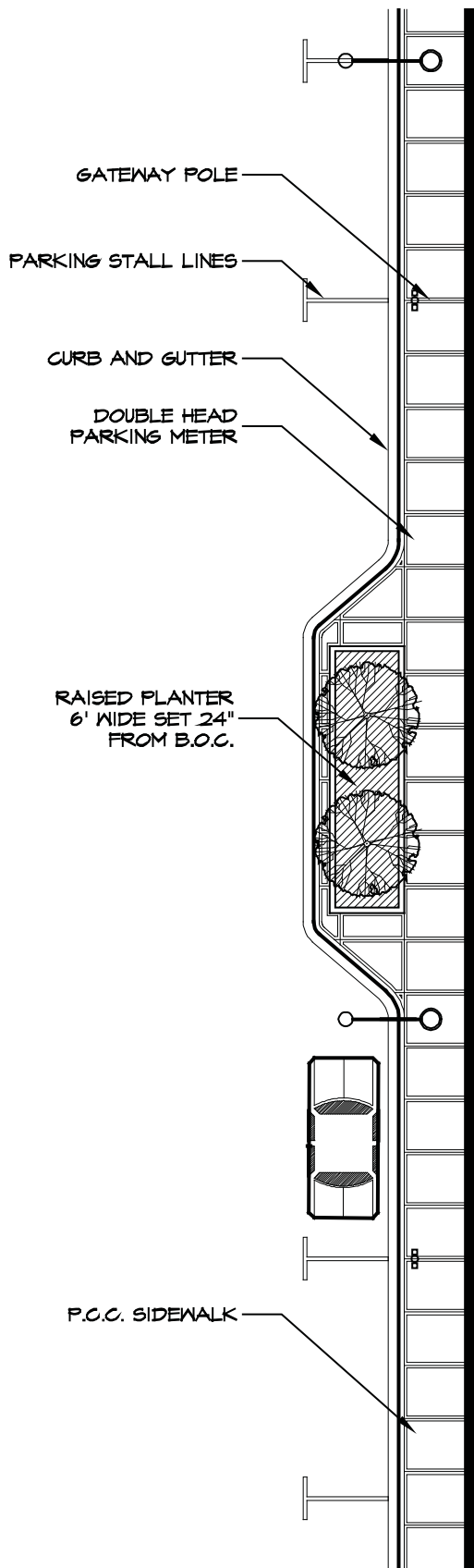

Figure 5-14: Plan of Concept A-3

Concept A-3

Sidewalk Width: Less than 9' Wide

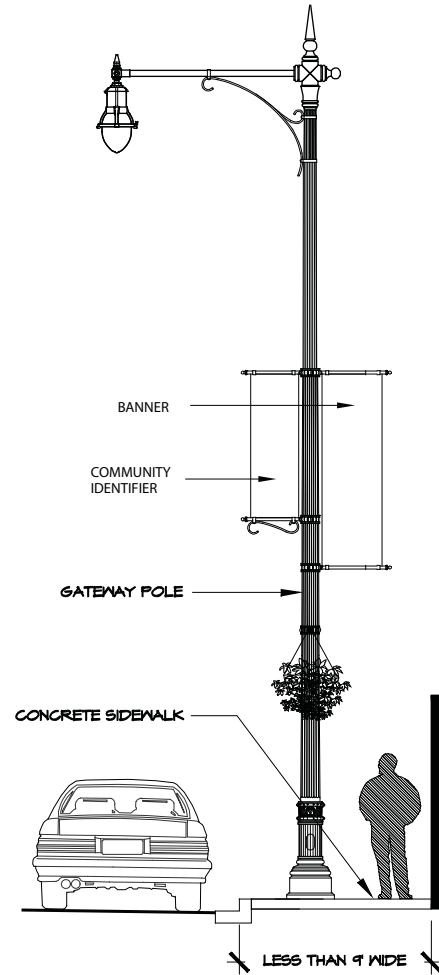

Figure 5-15: Section of Concept A-3

Concept A-3 continues building on A-1 and A-2 by creating a double curb extension in place of two parking spaces. This provides the opportunity to bring trees into the streetscape by incorporating a curbed planter. Vertical identifier elements and/or benches could also be accommodated in this space. In addition, banners and hanging



Fig. 5-16: Lawrence Avenue streetscape

**Streetscape Examples:
Sidewalks 9' Wide or Less**



Fig. 5-18: Curb extension allows for placement of community identifier on North Halsted Street



Fig. 5-17: Lawrence Avenue streetscape



Fig. 5-19: Hanging baskets and banners add interest in narrow sidewalk conditions



Figure 5-20: Pre-existing conditions for the Clark Street streetscape



Figure 5-21: Pre-existing conditions for the Irving Park Road streetscape



Figure 5-22: Pre-existing conditions for the Irving Park Road streetscape

baskets are added to the light poles.

SIDEWALKS 9'-12' WIDE

While the Concept A series deals with very narrow sidewalk conditions and limited streetscape amenities, the Concept B series of sidewalks in the 9'-12' range opens up the possibilities for enhanced streetscape environments.

Most of Chicago's sidewalks fall into this sidewalk width category. Wider sidewalks permit greater freedom of movement for pedestrians, which is beneficial in a commercial district. In addition, wider sidewalks allow the introduction of trees in tree grates as part of the streetscape, however sidewalks in this category are still too nar-



Figure 5-23: Pre-existing conditions for the 26th Street streetscape

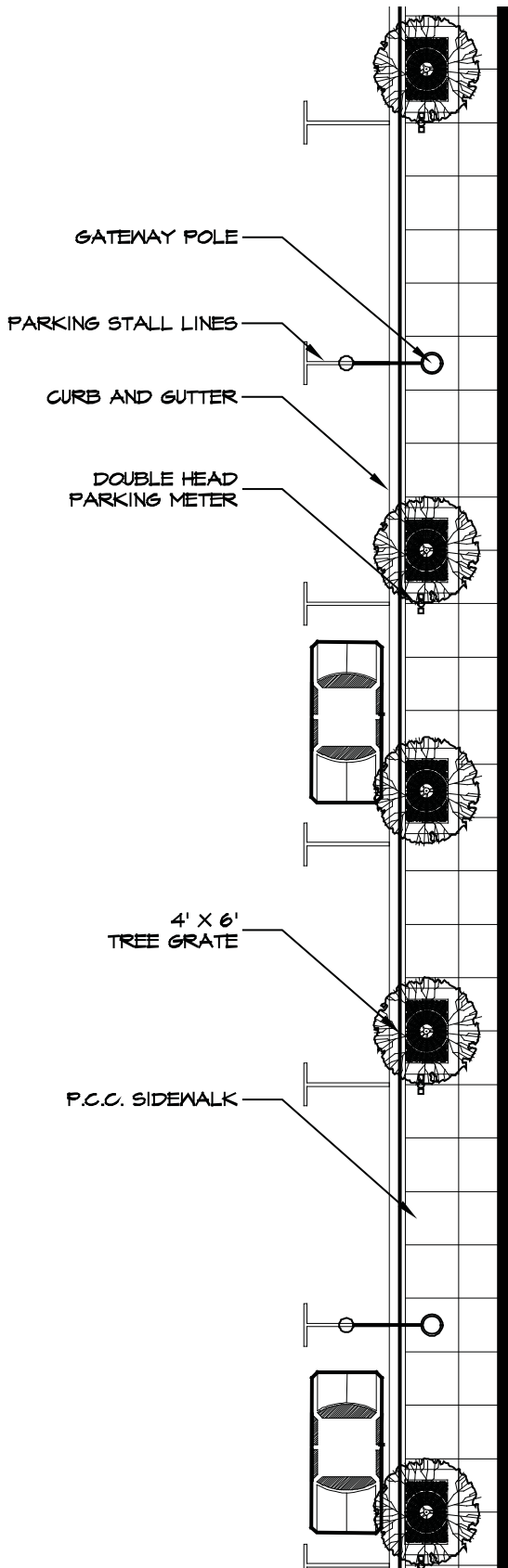

Figure 5-24: Plan of Concept B-1

row for curbed planters.

Concept B-1

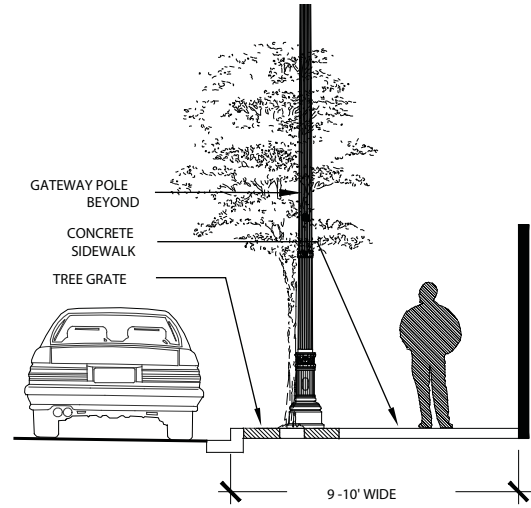

Figure 5-25: Section of Concept B-1

Sidewalk Width: 9'-10' Wide

Concept B-1 illustrates the basic streetscape with trees and Chicago Gateway 2000 poles. This concept includes:

- Chicago Gateway 2000 poles
- Double-head parking meters with posts set at the head of the parking stall on the parking stall centerline
- 4' x 6' tree grates placed at the back of curb and set at the back of the parking stall, 2' from the center of the parking meter post. Tree grates have a 1' wide concrete band on three sides to support the tree grate.

This concept orients the elements relative to the parking stalls which keeps the elements, such as light poles and tree trunks, out of

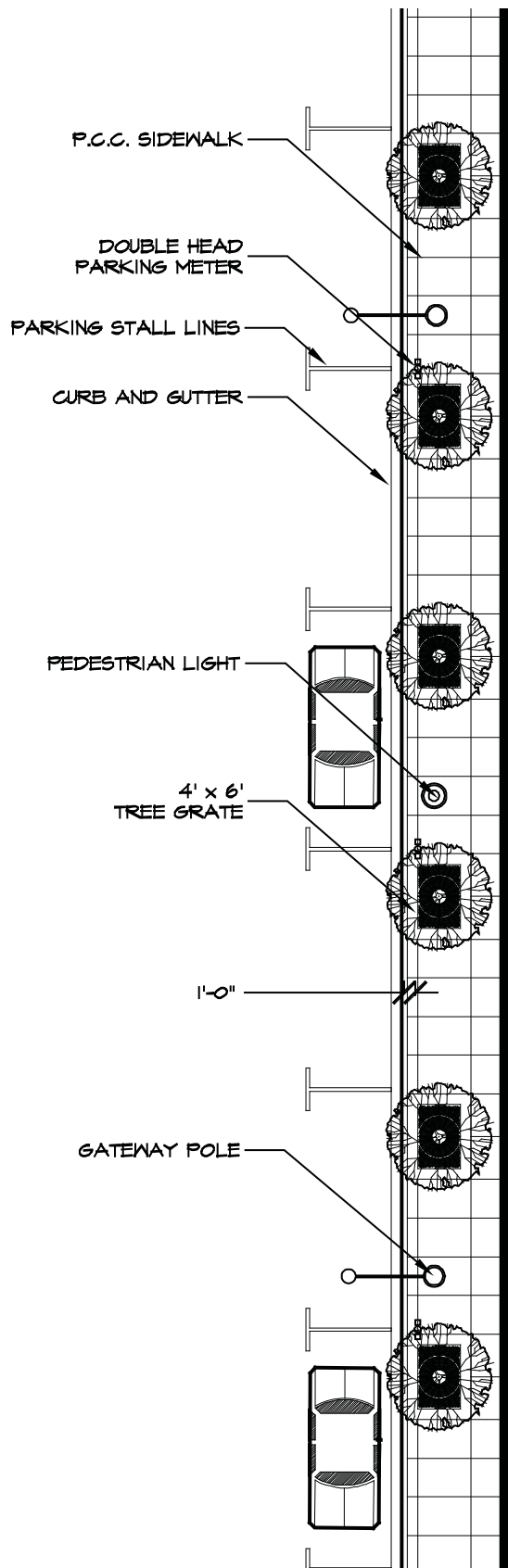

Figure 5-26: Plan of Concept B-2

the door swing areas of parked cars.

Concept B-2

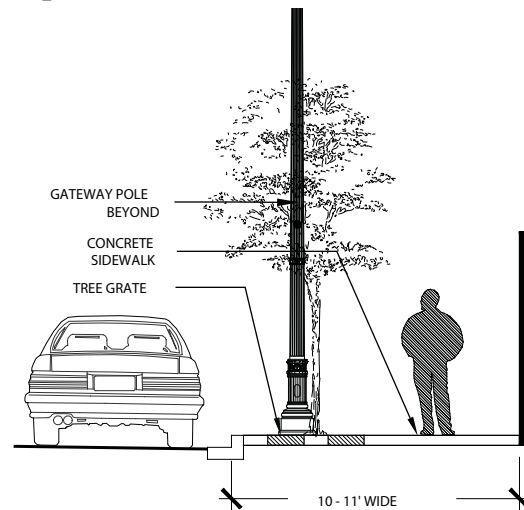

Figure 5-27: Section of Concept B-2

Sidewalk Width: 10'-11' Wide

Concept B-2 builds on Concept B-1 by adding pedestrian light poles to the streetscape element palette.

- Chicago Gateway 2000 poles are interspersed with Single Acorn pedestrian poles at regular intervals
- 4' x 6' tree grates, with 1' wide concrete banding, are set in a regular pattern at the same spacing as the parking stall dimensions
- Double-head parking meters are set at the front of the parking stall in line with the parking stall centerline

Unlike B-1, all of the streetscape elements except the parking meters are shifted from alignment with the parking stall centerlines. Instead, elements in Concept B-2 are set 5' either side of the parking stall centerline. This still keeps the trees and light poles out of the door swing areas generated by parked cars.

In addition, the tree grates are set 1' away from the back of curb. This setback also

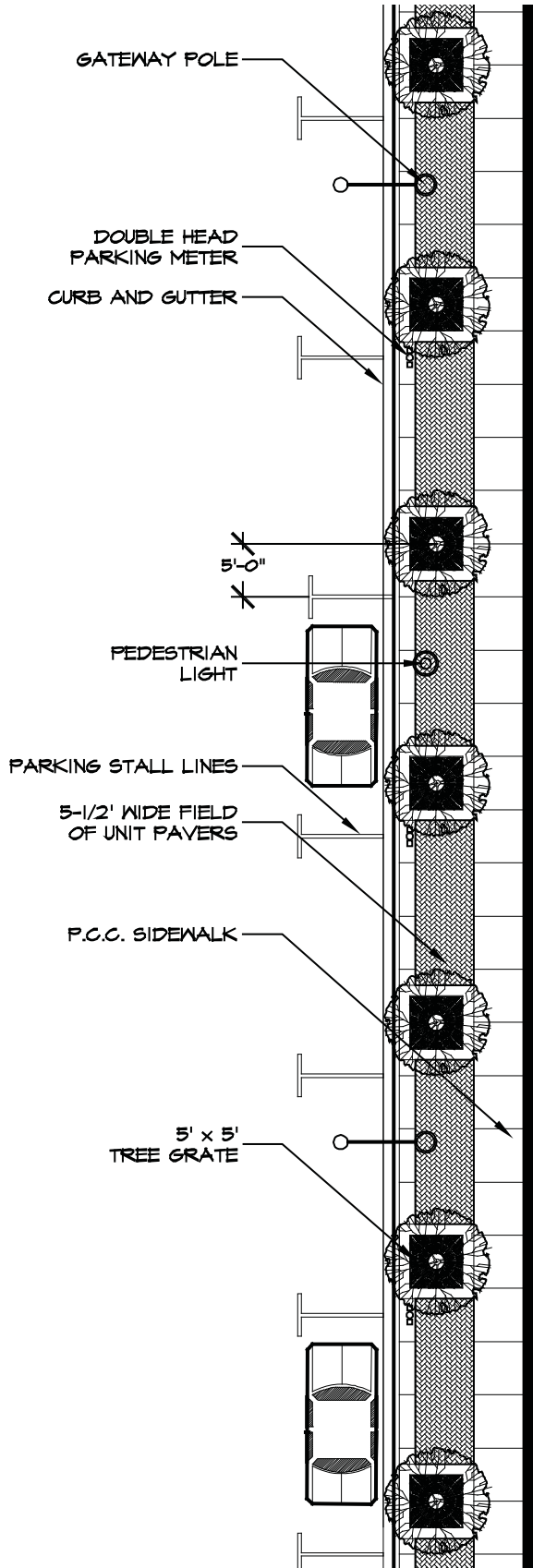

Figure 5-28: Plan of Concept B-3

helps to protect the trees from potential damage from car doors.

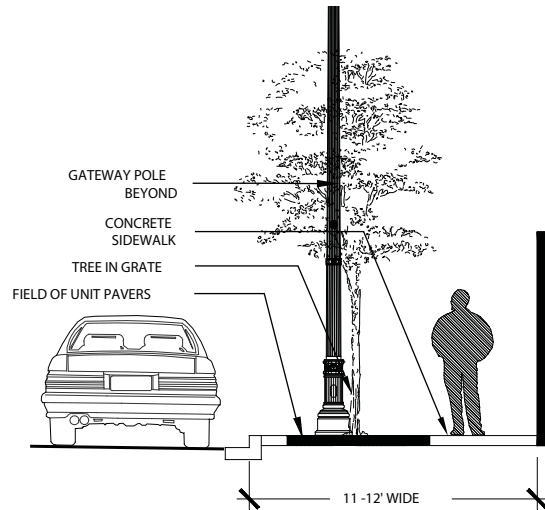

Figure 5-29: Section of Concept B-3

Concept B-3

Sidewalk Width: 11'-12' Wide

Concept B-3 illustrates a streetscape concept for 11'-12' wide sidewalks.

- 5' x 5' tree grates are set in a regular pattern 1' from the back of curb. A 1' wide concrete band surrounds the tree grate.
- Decorative pavement is included between the tree grates. There are many options for this decorative pavement, including precast concrete unit pavers, clay unit pavers, or special scored or stamped concrete pavement.

The spaces between tree grates provide more opportunities for amenities. These spaces



Figure 5-30: Irving Park Road



Figure 5-31: Clark Street

Streetscape Examples: Sidewalks 9'-12' Wide



Figure 5-32: 53rd Street



Figure 5-33: 53rd Street



Figure 5-34: Pre-existing conditions for the Grand Avenue streetscape



Figure 5-35: Pre-existing conditions for the Hegewisch neighborhood streetscape



Figure 5-36: Pre-existing conditions for the Hegewisch neighborhood streetscape

are out of the regular flow of pedestrians along the building face and can accommodate a variety of streetscape elements, such as kiosks, benches, trash receptacles, etc.

SIDEWALKS 12' WIDE OR GREATER

With the increase in overall sidewalk width comes the ability to increase the green space amenity in the streetscape. At an overall minimum sidewalk width of 12', raised planters are possible. This is based on the standard of a minimum overall planter width of 4', as measured from the inside of the planter curbs, and a preferred clear sidewalk width of 6'. Planters should not be installed immediately adjacent to the curb since the curbs would interfere with car door swings. A minimum setback of 12" is needed and with the added curb dimension of 6" a buffer of 18" is created.

In a number of streetscape corridors, the



Figure 5-37: Pre-existing conditions for the Howard Street streetscape

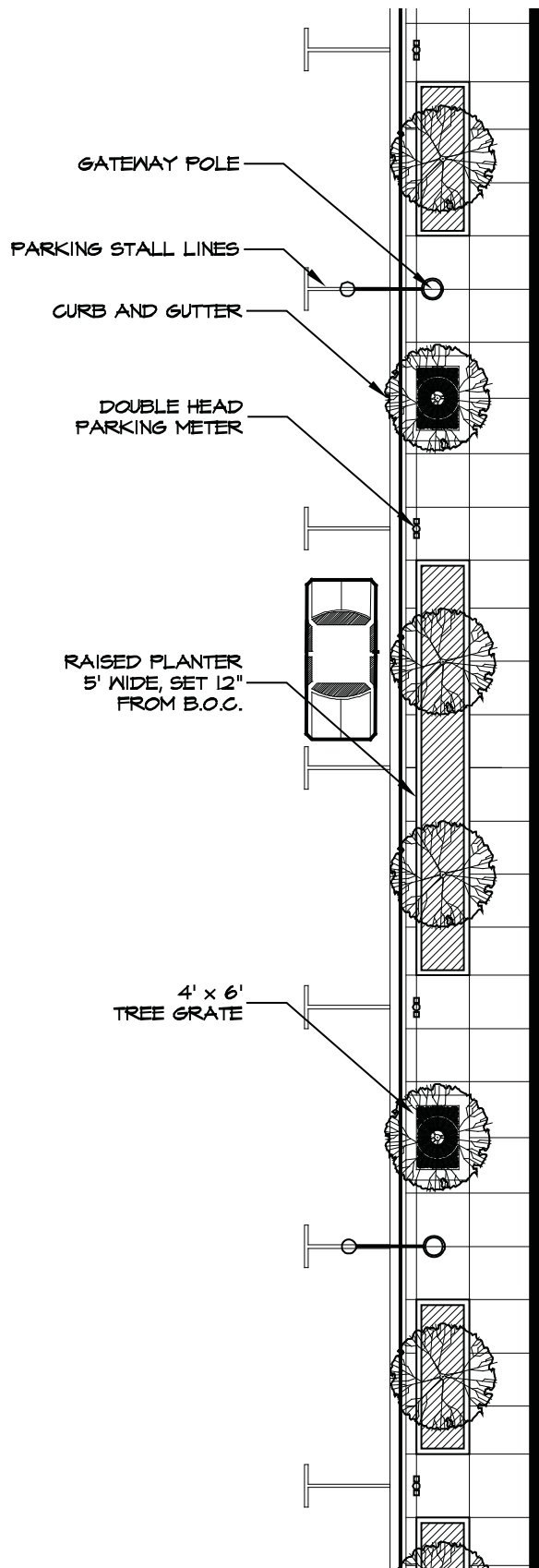

Figure 5-38: Plan of Concept C-1

sidewalk width is sufficient enough to generate substantial opportunities for amenities. The following concepts show a few of the

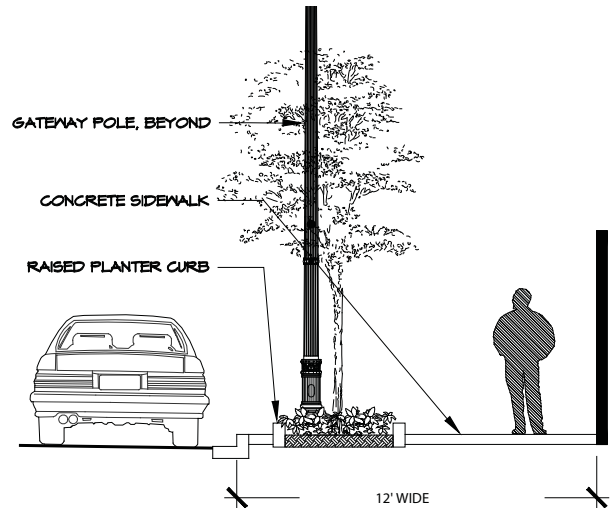

Figure 5-39: Section of Concept C-1

many options that could be used in wide sidewalk conditions.

Concept C-1

Sidewalk Width: 12' Wide

Concept C-1 illustrates a streetscape planter concept that includes Chicago Gateway 2000 poles and 5' wide raised planters interspersed with 4' x 6' tree grates. Parking meter posts and Chicago Gateway 2000 poles are set to align with parking stall centerlines. Planters are placed with overall gaps of 6' at the parking meters and 10' at the Chicago Gateway 2000 poles. These gaps provide access to the sidewalk for drivers leaving vehicles and feeding parking meters.

The planters in this concept could potentially vary in size from short to long. Longer planters would need to be carefully planned

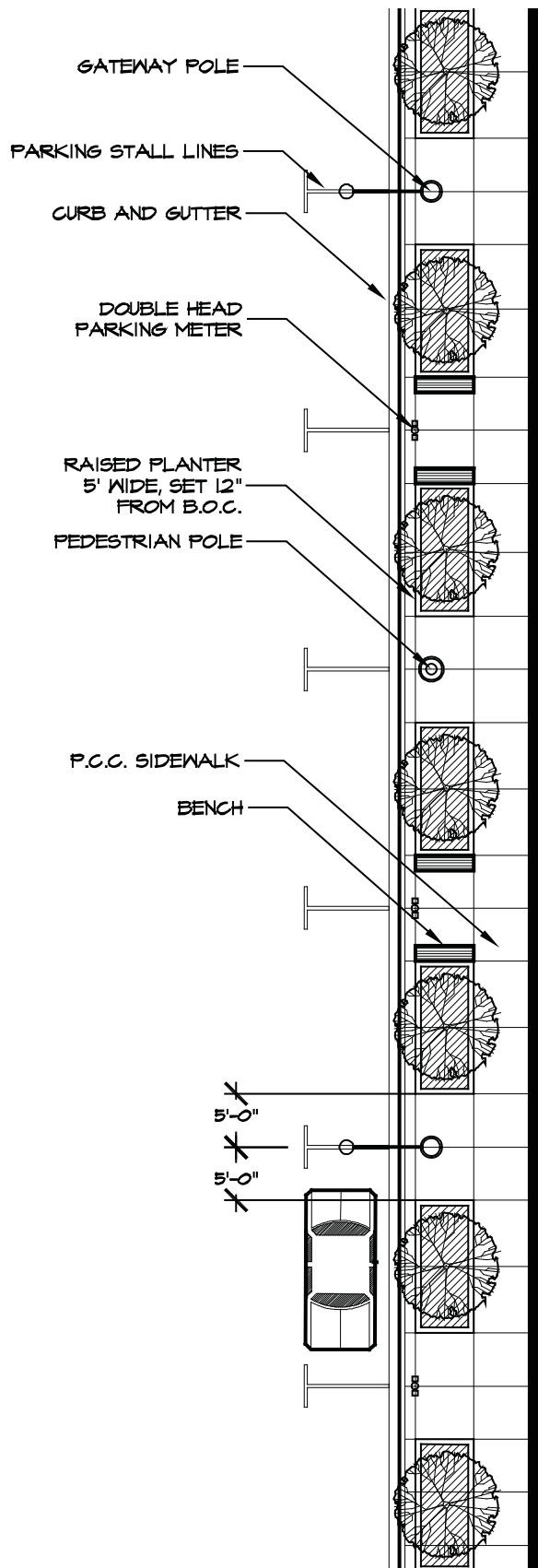

Figure 5-40: Plan of Concept C-2

in an actual streetscape since the long length could pose problems in areas with heavy pedestrian volumes. In areas of light-

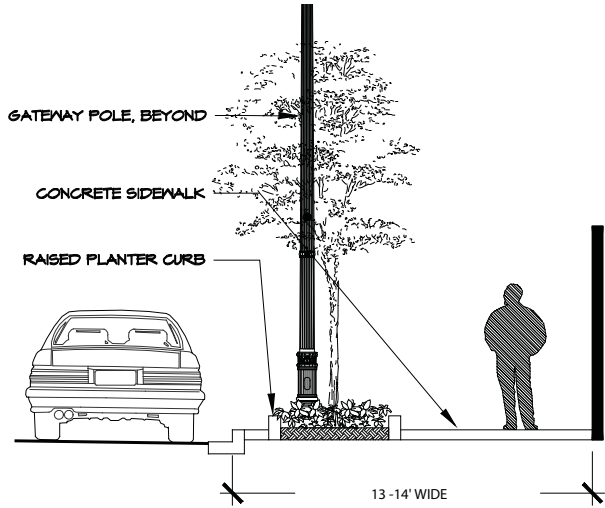

Figure 5-41: Section of Concept C-2

er pedestrian volumes, however, longer planters can increase green space opportunities.

Concept C-2

Sidewalk Width: 12' Wide

Concept C-2 builds on Concept C-1 by adding Single Acorn pedestrian poles between the Chicago Gateway 2000 poles.

Concept C-2 illustrates a streetscape planter concept that includes Chicago Gateway 2000 poles and 5' wide raised planters. Planters are placed with overall gaps of 10' at both the parking meters and at the Chicago Gateway 2000 poles. These gaps provide access to the sidewalk for drivers leaving their vehicles and feeding parking meters.

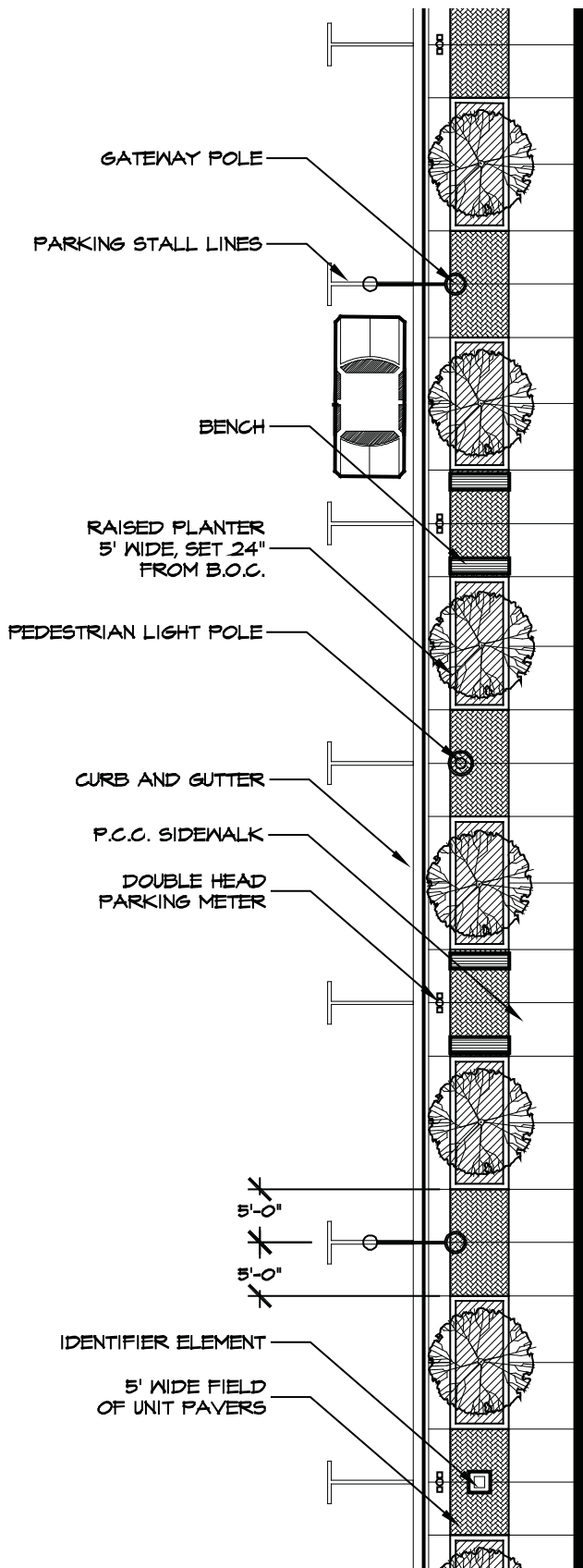

Figure 5-42: Plan of Concept C-3

The larger gaps between planters also create more opportunities for amenities. These spaces between the planters are out of the

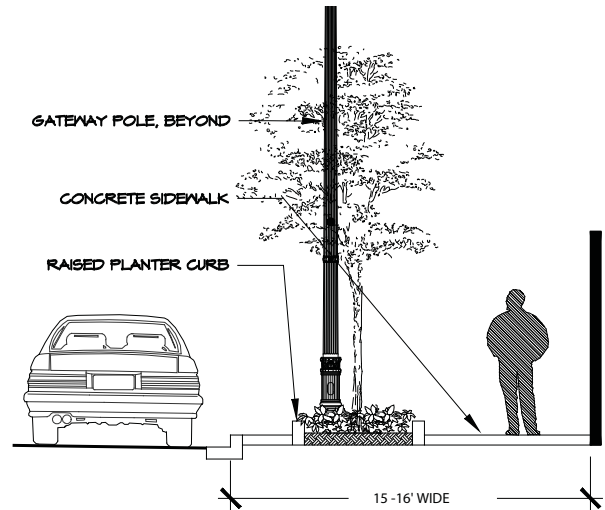

Figure 5-43: Section of Concept C-3

regular flow of pedestrians along the building face and can hold a number of streetscape elements, such as kiosks, benches, trash receptacles, etc.

Concept C-3

Sidewalk Width: 15'-16' Wide

Concept C-3 illustrates a streetscape concept in a sidewalk with an overall width of 15'-16'. It is similar in arrangement to Concept C-2 except that decorative pavers are included between the planters.

There are a variety of options available for this decorative band:

- Unit pavers - a decorative paver border

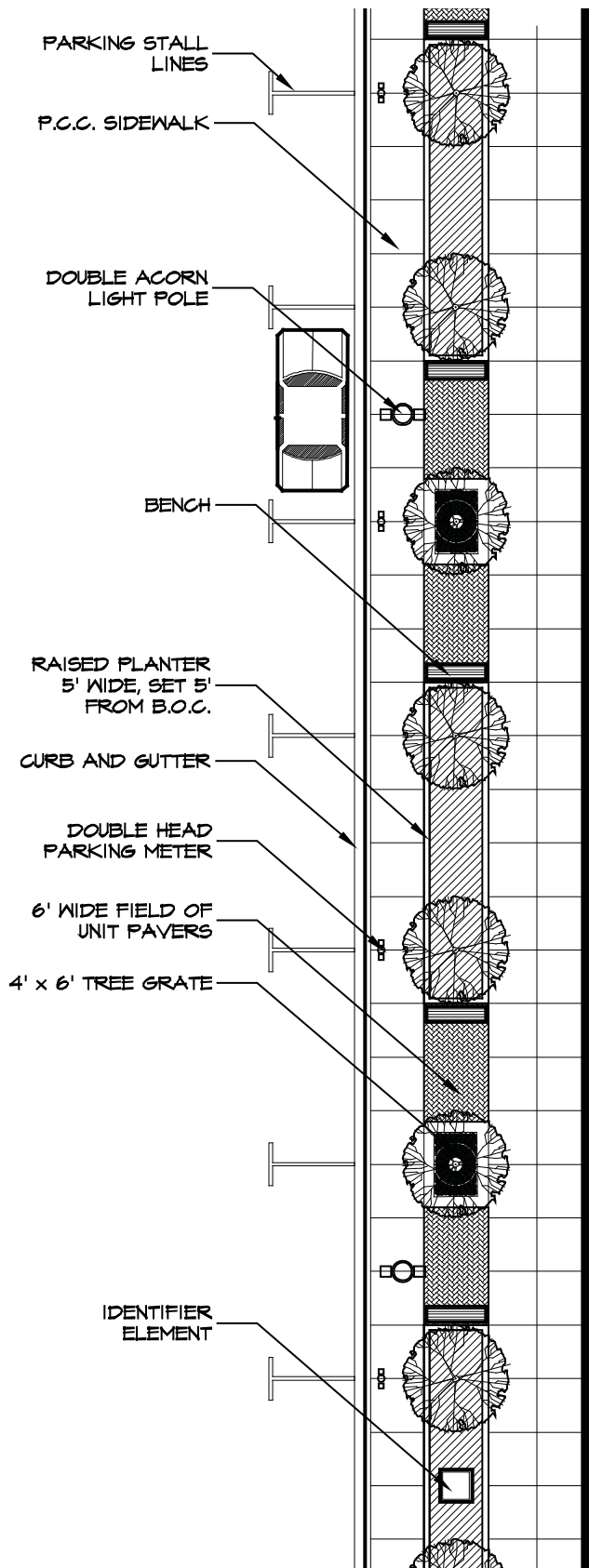

Figure 5-44: Plan of Concept C-4

- Special scored or stamped concrete paving

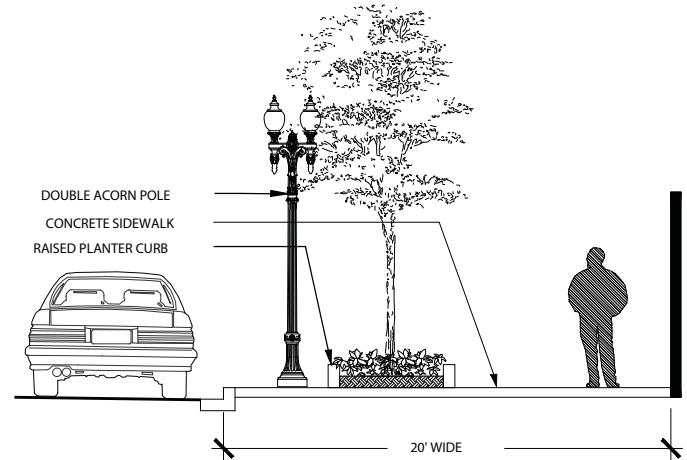

Figure 5-45: Section of Concept C-4

ment
 In addition, a vertical identifier element as well as seating areas are located in the spaces between planters not dedicated to light poles.

Concept C-4

Sidewalk Width: 20' Wide

In a number of limited areas in the City there are very wide sidewalks. In these instances the opportunity exists to combine multiple elements including trees in planters, trees in grates, a variety of lighting elements, benches, and identifier elements.

Concept C-4 illustrates a streetscape concept in a sidewalk width of 20'. It incorporates the following elements:

- Raised planters interspersed with tree grates
- Double Acorn pedestrian lights between planters and tree grates
- Seating areas between tree grates and planters

**Streetscape Examples:
Sidewalks 12' Wide or Greater**



Figure 5-46: Devon/Central streetscape



Figure 5-48: Lincoln Square streetscape



Figure 5-47: Hegewisch neighborhood streetscape



Figure 5-49: Grand Avenue streetscape



Figure 5-50: 47th Street streetscape

- Identifier element within one of the planters

While this concept uses Double Acorn lights along the length of the streetscape, Chicago Gateway 2000 light poles are necessary at street intersections where the photometrics need to be augmented. The larger gaps between planters create more opportunities for amenities. Benches are shown here, but a variety of elements could be used.

CONCLUSION

The successful design and construction of a streetscape project is a rewarding experience for the community in which it is built, as well as for the entire City of Chicago. Streetscapes help to define neighborhood character and enhance the urban fabric of the City. The ideas and standards presented throughout this guide are intended to help ensure this success. As current product installations are tested over time and new ideas and technologies are developed,



COMBINING STREETScape ELEMENTS

these guidelines will be updated to reflect new knowledge. Whatever the changes might be, the overall goal will remain the same: to make the City of Chicago a better place in which to live, work, and play.



COMPLETED STREETSAPES





When beginning a streetscape project it is often useful to visit projects that have already been completed. The following is a list of recently completed streetscapes:

- Lincoln Square and Giddings Plaza Renovation: Lincoln Avenue between Lawrence Avenue and Leland Avenue
- Clark Street Streetscape: Ainslie Street to Victoria Street
- Irving Park Road Streetscape: California Avenue to Kedzie Avenue
- Hegewisch Streetscape: Baltimore Avenue, 132nd Street to Brainard Avenue
- 47th Street Streetscape: St. Lawrence Avenue to Prairie Avenue
- 35th Street Streetscape: Ashland Avenue to Damen Avenue
- Devon Avenue Streetscape: Broadway to Clark Street
- Devon/Central Streetscape: Devon Avenue from Spokane Avenue to N. Lehigh Avenue; Central Avenue from N. Tahoma Avenue to Central Avenue
- Grand Avenue Streetscape: Harlem Avenue to Sayre Avenue
- Oak Street Streetscape: Michigan Avenue to Rush Street
- Lawrence Avenue Streetscape: Pulaski Road to Keeler Avenue
- 53rd Street Streetscape: Woodlawn Avenue to Hyde Park Boulevard
- 55th Street Streetscape: Lake Park Avenue to Hyde Park Boulevard
- Lincoln Avenue Streetscape: Grace Street to Montrose Avenue
- Howard Street Streetscape: N. Ridge Boulevard to N. Paulina Street
- 18th Street Streetscape: Throop Street to S. Paulina Street



COMMUNITY PARTICIPATION





Figure B-1: Community members participate in the streetscape design process

COMMUNITY PARTICIPATION

There are many ways that the private community can participate in streetscape improvements. A variety of programs and partnerships help bring both economic and physical community involvement in the maintenance of a streetscape. Programs range from City-sponsored programs such as the Façade Rebate Program and Special Service Area designations, as well as other local programs such as local chamber of commerce community maintenance programs, grants, and adopt-a-(planter, block, bench, etc.) programs.



Figure B-2: Community gardening effort



Figure B-3: The Facade Rebate Program provides rebates for storefront rehabilitation activities

FAÇADE REBATE PROGRAM

The Façade Rebate Program is designed to revitalize eligible neighborhood commercial and industrial areas in the City of Chicago. The program provides rebates for storefront rehabilitation activities, including complete façade renovation, exterior lighting, new signs, graphics, windows, doors, window displays, awnings, passive security systems, and energy conservation systems. Candidates apply through neighborhood business organizations or directly to the Chicago Department of Planning and Development.

Project Selection Criteria

Projects must meet at least one of the following Federal Community Development Block Grant requirements to be eligible for the Façade Rebate Program:

- Building is located in a low- or moderate-income census tract
- Building is located in a designated slum and blighted area (as designated by Chicago ordinance or Illinois statute)
- Project meets job creation requirements (applicant must create one permanent job for each \$10,000 of rebate)
- Project must be deemed necessary to prevent loss of low- or moderate-income jobs, or relocation of the business outside of the greater Chicago metropolitan area

Major funding sources are Federal Community Development Block Grants. For further information, contact the Chicago Department of Planning and Development, Landmarks Division, (312) 744-CITY.

SPECIAL SERVICE AREA PROGRAM

The Chicago Department of Planning and Development, working in cooperation with the Chicago Department of Law, can assist local commercial and industrial groups in establishing and administering a Special Service Area (SSA).

The SSA Program is an economic development tool that uses the levy of the real estate property tax in raising funds to provide special services for a targeted area. Property owners, within these targeted areas, choose to tax themselves in providing these services. Typically, only commercial and/or industrial parcels included in the SSA are subject to taxation. Religious, non-for-profit, and public facilities are excluded from the SSA tax.

The services funded through the SSA tax are in addition to services generally provided by the City. These services must predominantly benefit those properties located within the SSA that are subject to taxation. Examples of these services include: maintenance, sidewalk and street improvements, landscaping, parking management, security planning, advertising, promotion, business recruitment, and capital improvement financing. There are currently 18 active SSAs within Chicago: 17 of these are located in communities outside of the central business district, with one located in the Loop, on State Street.

Eligibility

Eligible applicants for participation in the SSA program include non-for-profit local development corporations, chambers of commerce, or other business/industrial groups operating within clearly defined commercial and/or industrial areas. Interested organizations are strongly encouraged to schedule a pre-application meeting with Chicago Department of Planning and Development



staff. This meeting will allow the interested organization to explore the SSA Program and identify the start-up costs and research involved in creating an SSA.

SSAs and Streetscape Projects

SSAs are a good complement to a streetscape project. If maintenance or capital dollars are incorporated in the budget of an SSA, there is more flexibility to include planters and/or community identifiers in a streetscape project. If a chamber of commerce is considering pursuing an SSA for their community, a great time to do this is during the design phase of a streetscape project.

For further information on the SSA Program, contact the Chicago Department of Planning and Development at 312-744-0705.



Figure B-4: Community maintenance is an important part of a successful streetscape

COMMUNITY MAINTENANCE AGREEMENT

In areas of streetscape improvements, the city requires community members to participate in the maintenance of certain streetscape elements and to sign an agreement stating their responsibility. As mentioned throughout this guide, the community is responsible for the maintenance of planters, planter pots, and hanging baskets in addition to parkways. A community's willingness to maintain streetscape improvements is ascertained prior to final streetscape design and implementation. It will also dictate the extent of streetscape improvements considered for that community. The Streetscape and Urban Design Program requires community members and groups who have agreed to take responsibility for planters to sign a form stating their intentions prior to construction.



COMMUNITY MAINTENANCE AGREEMENT



DATE: _____

Miguel d'Escoto
Commissioner
Department of Transportation
30 North La Salle Street
Chicago, Illinois 60602

Dear Commissioner Ware:

Please be advised that I would like to participate in the Department of Transportation's Bureau of Bridges and Transit's Streetscape project being built at _____ from _____ to _____.

My home/ business/ organization is located at _____ and I am willing to maintain the landscaping in the _____ planter(s) located at _____.

My responsibilities include: the removal of litter and debris, weeding, plant replacement and basic upkeep of the existing plants and watering if necessary. I will also report any damage or vandalism done to the planter to the City of Chicago for the scheduling of repairs or replacement.

Name/ Contact:

Organization:

Address:

Telephone:

E-mail:

Send to:

Janet Attarian
Project Director
Streetscape and Urban Design
Bureau of Bridges and Transit
Department of Transportation
30 North La Salle Street
Chicago, Illinois 60602

**STREETSCAPE DESIGN ELEMENTS
MAINTENANCE AND MANAGEMENT RESPONSIBILITIES**

STREETSCAPE ELEMENT	AGENCY RESPONSIBLE
Regulatory Signage, Directional Signs, Traffic Flow and Analysis, Street Traffic Direction, Traffic Signal Placement, and Timing	Chicago Department of Transportation, Bureau of Traffic
Roadway and Curb Marking, Sign Installation	Chicago Department Transportation, Bureau of Signs and Markings
Parking Meters, Driveway Permits, Building Sign Permits, and Vault Permits	Chicago Department of Revenue
Roadway Resurfacing and Reconstruction, Industrial Street Construction, Triangles, Roadway Median Planters, Irrigation	Chicago Department of Transportation, Bureau of Highways
Street Lighting, Viaduct Lighting	Chicago Department of Streets and Sanitation, Bureau of Electricity
Street Trees	Chicago Department of Streets and Sanitation, Bureau of Forestry
Bike Lanes and Racks	Chicago Department of Transportation, Bureau of Traffic
Park and Open Space Design	Chicago Park District, Chicago Department of Planning and Development
Economic Development, Tax Increment Financing, Special Service Areas, Facade Rebate Program	Chicago Department of Planning and Development
Capital Improvement Funding	Chicago Office of Budget and Management
Streetscaping as part of affordable housing	Chicago Department of Housing, Chicago Housing Authority
Large Kiosks, Pavillions, and Bus Shelters	Mayor’s Office, Infrastructure Liaison
Fountains	Chicago Department of Transportation, Bureau of Bridges and Transit
Sewer Mains and Services	Chicago Department of Water Management
Water Mains and Services	Chicago Department of Water Management
Emergency Communication Lines	Chicago Office of Emergency Management and Communications
Permits for work in the public right-of-way	Chicago Department of Transportation, Bureau of Inspections



LANDSCAPE RESOURCES





Figure C-1: Extensively planted streetscapes require hardy plant selection as well as a community commitment to ongoing maintenance

LANDSCAPE RESOURCES

A variety of codes and conditions must be accommodated when planning landscape improvements within the City of Chicago.

THE LANDSCAPE ORDINANCE

As the urban metropolis that started the City Beautiful movement, Chicago continues to be at the forefront of creating tree-lined streets and boulevards. The objective of the Chicago Landscape Ordinance is to establish minimum standards for size, placement, orientation, and preferred species for trees, shrubs, and other plantings in the public way. It also covers use of planters, structural soil, screening for parking lots and structures, ornamental fencing, and other enhancements. *Guide to the Chicago Landscape Ordinance* is a publication that summarizes and explains the requirements of the Chicago Landscape Ordinance. It is available from the Chicago Department of Planning and Development, located in City Hall.

URBAN-TOLERANT TREE SPECIES

The City of Chicago provides a variety of resources on trees that are successful in the urban environment. The Department of Environment currently maintains a website that provides a guide to urban trees that lists suggested tree species for parkway and sidewalk tree pits. These are urban hardy trees, capable of growing under the adverse conditions often experienced in a streetscape: extreme temperatures, pollution, road salt-spray, and roadway drainage runoff. The Bureau of Forestry and the Chicago Department of Transportation also offer landscape resources.

The Chicago Department of Environment website is: **www.ci.chi.il.us/Environment**

The Chicago Bureau of Forestry can be contacted at 312-747-2101.

The Chicago Department of Transportation can be contacted at 312-744-3600.



Figure C-2: Mature trees are a valuable asset that must be protected

LANDSCAPE QUARANTINE ZONES

With the incursion of Asian Long-horned Beetles in the City of Chicago, the Bureau of Forestry has established quarantine zones throughout the city and has specified certain tree species for these areas. Since the knowledge base about this infestation is constantly being updated, it is best to contact the Asian Longhorned Beetle Eradication Office for the most up-to-date information on host species and current quarantine zone boundaries.

The Asian Long-horned Beetle Eradication Office can be contacted at 312-742-3385.

PROTECTION OF TREES

In accordance with Municipal Code Title 10 Chapter 32, once planted in a parkway, a tree shall become and remain the property of the city and shall be subject to the provisions of that Chapter of the Municipal Code. This includes protection of trees during building operations. Injury to a public tree or shrub may result in fines. For more information, refer to the Municipal Code. For current policies and procedures regarding tree protection in the public way, and for copies of tree protection specifications, contact:

Department of Streets and Sanitation
Bureau of Forestry
3200 S. Kedzie Ave.
Chicago, IL 60623
312-747-2101

ACKNOWLEDGEMENTS

Chicago Department of Transportation

Miguel d'Escoto, Commissioner

Thomas Powers, Deputy Commissioner

Stan Lee Kaderbeck

Janet Attarian

Michelle Woods

Scott Waldinger

Irma Lara

Glibel Gomez

Simon Chan

Eniko Zonger

T.Y. Lin International

John LaPlante

Hayden Bulin Larson Design Group, Ltd.

Jennifer Bulin Larson

Richard C. Hayden

Deborah A. Samyn

Michael D. Snow

Ryan P. Scherner

Kristen Glass

Mary Gardocki

Joshua D. Anderson