



City of Chicago



O2019-6843

Office of the City Clerk

Document Tracking Sheet

Meeting Date:	9/18/2019
Sponsor(s):	Misc. Transmittal
Type:	Ordinance
Title:	Zoning Reclassification Map No. 2-I at 731-799 S Washtenaw Ave and 2609-2659 W Harrison St - App No. 20196
Committee(s) Assignment:	Committee on Zoning, Landmarks and Building Standards

#20196

INTRO DATE

SEPT 18, 2019

ORDINANCE

BE IT ORDAINED BY THE CITY COUNCIL OF THE CITY OF CHICAGO:

SECTION 1. Title 17 of the Municipal Code of Chicago, the Chicago Zoning Ordinance, is hereby amended by changing all of the M1-1 Limited Manufacturing/Business Park District and C1-2 Neighborhood Commercial District symbols and indications as shown on Map. No. 2-I in the area bounded by:

The centerline of West Harrison Street; the west boundary of the Union Pacific Railroad Right of Way; the centerline of West Polk Street; the west boundary of the Union Pacific Railroad right of way; the north line of West Taylor Street; a line that is parallel to and 19.50 feet east of the west line of vacated South Washtenaw Avenue; the south line of the first 16-foot east-west alley south of West Polk Street; the west line of vacated South Washtenaw Avenue; the centerline of West Polk Street; the centerline of South Washtenaw Avenue.

to those of a C3-1 Commercial, Manufacturing and Employment District then to an Institutional Planned Development which is hereby established in the area described.

SECTION 3. This ordinance takes effect after its passage and publication.

Address of Property: 731-799 South Washtenaw Ave./2605-59 West Harrison Street

**CHICAGO HOPE ACADEMY & CHICAGO LIONS CHARITABLE ASSOCIATION
PROPOSED INSTITUTIONAL PLANNED DEVELOPMENT
NARRATIVE**

I. Applicants

A. Chicago Lions Charitable Association

The Chicago Lions Charitable Association is a 501(c)3 not-for-profit association (the “CLCA”). CLCA fosters and promotes rugby sports competition more broadly among the general populations. Through this multi-generational charitable approach, CLCA can promote healthy physical activities in a competitive environment.

B. Chicago Hope Academy

Chicago Hope Academy is a 501(c)3 Illinois corporation (the “CHA”). CHA is a private Christian academy currently operating at 2189 West Bowler Street, the former home of St. Callistus school, located on the near west side of Chicago. Since 2015, CHA has provided College Prep curriculum with a commitment to small classrooms, as its average classroom size includes 12 students. CHA’s existing high school consists of 230 students, 20 teachers and 14 staff members. CHA’s plan for its high school campus CHA/CLCA’s plans for its athletic fields are detailed in III below.

II. Existing Site Conditions

The subject property is generally bounded by West Harrison Street on the north, West Taylor Street on the south, South Washtenaw Avenue on the west and the elevated portion of the Union Pacific Railroad on the east. The subject property consists of a net site area of 859,371 square feet and is partially improved with a) existing 2-story Quest gymnasium and an outdoor running track, b) west athletic field (projected completion August 2019) and c) 112 existing parking spaces. The remainder of the Subject Property is vacant.

The Subject Property is located within the M1-1 District and C3-1 Districts.

A. Western/Ogden Industrial Corridor

The Subject Property is located within the Western/Ogden Industrial Corridor. The portion of the site is in a geographically remote and isolated section of the Industrial Corridor, at its northern and most western point and is bordered by residential zoning and open space. The raised Union Pacific railroad is located to the east. The property south of West Taylor Street (and subject to the proposed Special Use), is a large parcel

occupied by a vacant industrial building. There is no active industrial use in this section of the Industrial Corridor or close to the Subject Property.

The paucity of industry in the area is reflected in employment numbers. The study of Industrial Corridors commissioned by the City's Department of Planning & Development in 2013 documented a 44.3% employment loss overall in the Western/Ogden Industrial Corridor between 2002 and 2011. The proposed school and community athletic fields complement the nearby homes and Altgeld Park. As such, they are very good land uses for transition from the commercial/manufacturing activities to the south and the residential uses on the west and north.

III. Proposed Institutional Planned Development

The Applicants, CLCA and CHA, are seeking a Planned Development in order to construct an interactive school campus, which will include a private high school, two community athletic fields, indoor/outdoor athletic facilities and accessory parking lot(s) for a total of 612 on-site parking spaces, of which 325 off-site accessory parking spaces will seek Special Use approval simultaneously with the proposed Planned Development. As the Subject Property exceeds 2 acres, a Mandatory Planned Development is required in order to establish the proposed school campus. (Section 17-8-0506 of Chicago Zoning Ordinance).

A. Proposed Athletic Fields

CLCA plans to develop two (2) artificial turf community athletic fields, a fieldhouse (consisting of 11,000 sq. ft.) and accessory parking. The athletic fields, containing a total of 352,052 square feet, will include seating for 6,120 people. Spectator and participant sports will be played on both the east and west athletic fields. Construction of the west athletic field is scheduled for completion in August 2019. Adequate lighting will be provided at both athletic fields for evening activities. CLCA also plans to possibly seasonally "dome" the eastern athletic field and establish a mid-block crosswalk between the athletic fields to CHA's proposed high school described below.

1) Use and Availability of Athletic Fields

CLCA intends that the athletic fields be utilized to the fullest extent possible, and will be utilized by both CHA and CLCA. It is envisioned that other entities, such as the Noble Charter schools, CPS schools (elementary, middle and high school) located within close proximity of the subject property will also be able to use the fields.

The athletic fields will also be available to neighborhood based and volunteer driven leagues, coordinated by the CLCA/CHA managers. Youth rugby and soccer leagues are also envisioned in conjunction with Rugby Illinois, Chicago Wapiti Rugby clubs, AYSO and other soccer organizations.

In addition to CHA sports, the founder of Chicago Hope, Bob Muzikowski, founded the Near West Little League (NWLL) in 1995, which has culminated into the largest urban Little League. NWLL has been continuously operating at Altgeld Park, Livingston Park (Park 510), Skinner Park, Sheridan Park and other west side parks. NWLL will have access to CHA/CLCA athletic fields, of which the eastern “domed” field will prove useful for practices during the prolonged Chicago winter season

In addition to actual players, the proposed athletic fields will bring in a large number of spectators. CLCA rugby matches will bring in 60 players and coaches, and approximately 500 spectators. However, the number of spectators will increase due to the growth of the Lions for Hope youth academy’s rugby events. CHA matches, as well as Noble and other youth matches, will include approximately 40-50 players and less than 50 spectators.

CHA/CLCA’s athletic fields could also “host” soccer or rugby festivals. For example, 8 teams playing on the fields throughout one day could generate up to 250 players and coaches, as well as 750-1000 spectators.

2) Days and Hours of Operation

The Applicant is finalizing its Spring, Summer and Fall schedules which will dictate the days and hours of operation specific to each user of its proposed athletic fields.

B. Community Amenities

CHA and CLCA plans to establish amenities for the neighborhood, as well as CHA students and CLCA rugby players and spectators can enjoy. Such amenities include the following:

Dog Park: 2,500 sq. ft.
Community Garden: 1,300 sq. ft.
Memorial, Flags & Donor Recognition Wall: 650 sq. ft.
Entry Gathering Terrace: 4,900 sq. ft.
Playground: 2,300 sq. ft.
Pickleball Courts: 5,700 sq. ft.
Tennis Court: 9,000 sq. ft.
Batting Cage: 1,800 sq. ft.

C. Chicago Hope Academy High School

To the north of the athletic fields, CHA proposes to construct a new building (consisting of 148,836 sq. ft.) which will serve as a private (reduced tuition) high school. With a pedestrian link between its proposed school building and Quest Multiplex (consisting of 55,794 sq. ft. and which will continue as a commercial facility), CHA's overall school facility will consist of a total of approximately 205,000 sq. ft., including indoor basketball courts among other athletic uses.

CHA has a projected student enrollment of approximately 600 students. The proposed school will include a gymnasium, existing football field and track, and 1,000 bleacher seats. Accessory parking will be provided for use by faculty and staff.

The high school's proposed hours of operation will be M-F 7:00 a.m. – 6:00 p.m., detailed as follows:

- School: 7:00 a.m. – 3:00 p.m.
- Athletics and After School activities: 3:30 p.m. – 5:30 p.m.
- Weekends and Summer: 8:00 a.m. – 4:00 p.m.

In terms of transportation, 60% of students will take public transportation, 25% of students will be dropped off at the school and 15% of the students will walk or ride bikes. CHA does not offer a bus system and it is against CHA policy for students to drive to school.

D. Proposed parking lot

CLCA and CHA are planning on purchasing the city owned property, consisting of 122,397 square feet, located directly south of West Taylor Street (2601 West Taylor). In addition, CLCA and CHA are in active discussions with American Tower, in regards to potential lease or sale of the area directly east of its cell tower in order to include such property in Applicants proposed development. Although the proposed parking lot is part of the Applicants' interactive school campus, this property south of West Taylor Street will be established as off-site accessory parking through Special Use approval.

E. Proposed PD uses

The proposed uses include the following:

- Sports and Recreation, Participant, Outdoor & Indoor
- Spectator Sports, Large Venue (1,000+ capacity)
- School
- Accessory Parking
- Community Centers, Recreation Buildings and Similar Assembly Use

F. CHA incubator

Chicago Hope Academy plans to operate a business incubator within the proposed interactive school campus. The business incubator program(s) will focus on providing services to individuals seeking to establish careers in vocational trades, including construction and automotive trades. CHA's proposed business incubator program will be offered not only CHA high school students, but participants in other programs (i.e. Chicago CRED).

G. Community outreach

A community meeting detailing CLCA & CHA's proposed project was hosted by Alderman Jason Ervin on January 17, 2018, and the Applicants have participated in subsequent meetings with Alderman Ervin.

H. City Funds or Incentives

No public incentives are being sought. Applicants are seeking to purchase City-owned property at 2601 West Taylor through the City's Negotiated Sales process.

I. Sustainable Development Policy

Applicants are aware of the City of Chicago's Sustainable Development Policy for Planned Development projects. The Applicants will identify the options from the Sustainable Strategies Menu that it will utilize during its proposed phases of development and submit prior to presentation of the proposed Planned Development before the Chicago Plan Commission.

J. MBE/WBE Hiring Strategy

The Applicants are aware of the City's MBE/WBE policy for Planned Development projects. The City has adopted employment goals of 26% MBE, 6% WBE, 50% City Residency, of which 10% includes residents from the 28th ward. The Applicants are aware of these goals as they apply not only due to the PD, but also due to its proposed acquisition of city-owned property (2601 West Taylor).

The Applicants will develop a strategic plan for marketing those jobs, and understands that it will be required to submit its plan to Department of Planning & Development prior to presentation of the proposed Planned Development to the Plan Commission.

STANDARD PLANNED DEVELOPMENT STATEMENTS

The Planned Development Statements describe the legal regulations and conditions that will control the development of the proposed project. The following statements shall be included in the ordinance; any proposed changes to these statements must be discussed and reviewed with the Chicago Department of Planning and Development.

1. The area delineated herein as Institutional Planned Development Number _____, (Planned Development) consists of a net site area of approximately 859,371 square feet of property which is depicted on the attached Planned Development Boundary and Property Line Map (Property) and is owned or controlled by the Applicants, Chicago Hope Academy and Chicago Lions Charitable Association.
2. The requirements, obligations and conditions contained within this Planned Development shall be binding upon the Applicant, its successors and assigns and, if different than the Applicant, the legal title holders and any ground lessors. All rights granted hereunder to the Applicant shall inure to the benefit of the Applicant's successors and assigns and, if different than the Applicant, the legal title holder and any ground lessors. Furthermore, pursuant to the requirements of Section 17-8-0400 of the Chicago Zoning Ordinance, the Property, at the time of application for amendments, modifications or changes (administrative, legislative or otherwise) to this Planned Development are made, shall be under single ownership or designated control. Single designated control is defined in Section 17-8-0400.
3. All applicable official reviews, approvals or permits are required to be obtained by the Applicant or its successors, assignees or grantees. Any dedication or vacation of streets or alleys or grants of easements or any adjustment of the right-of-way shall require a separate submittal to the Department of Transportation on behalf of the Applicant or its successors, assigns or grantees.

Any requests for grants of privilege, or any items encroaching on the public way, shall be in compliance with the Planned Development.

Ingress or egress shall be pursuant to the Planned Development and may be subject to the review and approval of the Departments of Planning and Development and Transportation. Closure of all or any public street or alley during demolition or construction shall be subject to the review and approval of the Department of Transportation.

Pursuant to a negotiated and executed Perimeter Restoration Agreement ("Agreement") by and between the Department of Transportation's Division of Infrastructure Management and the Applicant, the Applicant shall provide improvements and restoration of all public way adjacent to the property, which may include, but not be limited to, the following as shall be reviewed and determined by the Department of Transportation's Division of Infrastructure Management:

Applicants: Chicago Hope Academy/Chicago Lions Charitable Association
Address: 731-799 South Washtenaw/2605-59 West Harrison Street
Date of Introduction: September 18, 2019
Plan Commission

- Full width of streets
- Full width of alleys
- Curb and gutter
- Pavement markings
- Sidewalks
- ADA crosswalk ramps
- Parkway & landscaping

The Perimeter Restoration Agreement must be executed prior to any Department of Transportation and Planned Development Part II review permitting. The Agreement shall reflect that all work must comply with current Rules and Regulations and must be designed and constructed in accordance with the Department of Transportation's Construction Standards for work in the Public Way and in compliance with the Municipal Code of Chicago Chapter 10-20. Design of said improvements should follow the Department of Transportation's Rules and Regulations for Construction in the Public Way as well as The Street and Site Plan Design Guidelines. Any variation in scope or design of public way improvements and restoration must be approved by the Department of Transportation.

4. This Plan of Development consists of 17 Statements: a Bulk Regulations Table; an Existing Zoning Map; an Existing Land-Use Map; a Planned Development Boundary and Property Line Map; ; Overall Site Plan; Proposed Site Plan (North Half); Proposed Site Plan (South Half); Pedestrian and Vehicular Access Plan; Floor Plans; Landscape Plans and Building Elevations (North, South, East and West) prepared by Team A| Architecture and dated (date of Plan Commission presentation), submitted herein. Full-sized copies of the Site Plan, Landscape Plan and Building Elevations are on file with the Department of Planning and Development. In any instance where a provision of this Planned Development conflicts with the Chicago Building Code, the Building Code shall control. This Planned Development conforms to the intent and purpose of the Chicago Zoning Ordinance, and all requirements thereto, and satisfies the established criteria for approval as a Planned Development. In case of a conflict between the terms of this Planned Development Ordinance and the Chicago Zoning Ordinance, this Planned Development shall control.

5. The following uses are permitted in the area delineated herein as a Planned Development TBD: (list uses as they are defined in the Chicago Zoning Ordinance). .
 - Sports and Recreation, Participant, Outdoor & Indoor
 - Spectator Sports, Large Venue (1,000+ capacity)
 - School
 - Accessory Parking
 - Community Centers, Recreation Buildings and Similar Assembly Use

Applicants: Chicago Hope Academy/Chicago Lions Charitable Association
 Address: 731-799 South Washtenaw/2605-59 West Harrison Street
 Date of Introduction September 18, 2019
 Plan Commission

6. The existing 2-story building, in which Quest Multisport is located, will continue operating as a commercial facility. The Applicants' proposed Planned Development will not impede on Quest's ability to continue to rent its indoor basketball courts/athletic facilities for a fee to the general public.
7. The overall development will include a total of 612 parking spaces, including 287 on-site accessory parking spaces and 325 off-site accessory parking spaces. The proposed 325 off-site accessory parking spaces will be secured through Special Use approval.
8. On-Premise signs and temporary signs, such as construction and marketing signs, shall be permitted within the Planned Development, subject to the review and approval of the Department of Planning and Development. Off-Premise signs are prohibited within the boundary of the Planned Development.
9. For purposes of height measurement, the definitions in the Chicago Zoning Ordinance shall apply. The height of any building shall also be subject to height limitations, if any, established by the Federal Aviation Administration.
10. The maximum permitted floor area ratio (FAR) for the Property shall be in accordance with the attached Bulk Regulations and Data Table. For the purpose of FAR calculations and measurements, the definitions in the Zoning Ordinance shall apply. The permitted FAR identified in the Bulk Regulations and Data Table has been determined using a net site area of 859,371 square feet and a base FAR of 1.2.
11. Upon review and determination, Part II Review, pursuant to Section 17-13-0610, a Part II Review Fee shall be assessed by the Department of Planning and Development. The fee, as determined by staff at the time, is final and binding on the Applicant and must be paid to the Department of Revenue prior to the issuance of any Part II approval.
12. The Site and Landscape Plans shall be in substantial conformance with the Landscape Ordinance and any other corresponding regulations and guidelines, including Section 17-13-0800. Final landscape plan review and approval will be by the Department of Planning and Development. Any interim reviews associated with site plan review or Part II reviews, are conditional until final Part II approval.
13. The Applicant shall comply with Rules and Regulations for the Maintenance of Stockpiles promulgated by the Commissioners of the Departments of Streets and Sanitation, Fleet and Facility Management and Buildings, under Section 13-32-085, or any other provision of the Municipal Code of Chicago.

Applicants: Chicago Hope Academy/Chicago Lions Charitable Association
Address: 731-799 South Washtenaw/2605-59 West Harrison Street
Date of Introduction: September 18, 2019
Plan Commission:

14. The terms and conditions of development under this Planned Development ordinance may be modified administratively, pursuant to Section 17-13-0611-A, by the Zoning Administrator upon the application for such a modification by the Applicant, its successors and assigns and, if different than the Applicant, the legal title holders and any ground lessors.
15. The Applicant acknowledges that it is in the public interest to design, construct and maintain the project in a manner which promotes, enables and maximizes universal access throughout the Property. Plans for all buildings and improvements on the Property shall be reviewed and approved by the Mayor's Office for People with Disabilities to ensure compliance with all applicable laws and regulations related to access for persons with disabilities and to promote the highest standard of accessibility.
16. The Applicant acknowledges that it is in the public interest to design, construct, renovate and maintain all buildings in a manner that provides healthier indoor environments, reduces operating costs and conserves energy and natural resources. The Applicant shall obtain the number of points necessary to meet the requirements of the Chicago Sustainable Development Policy, in effect at the time the Part II review process is initiated for each improvement that is subject to the aforementioned Policy and must provide documentation verifying compliance.
17. The Applicant acknowledges that it is the policy of the City to maximize opportunities for Minority and Women-owned Business Enterprises ("M/WBEs") and city residents to compete for contracts and jobs on construction projects approved through the planned development process. To assist the city in promoting and tracking such M/WBE and city resident participation, an applicant for planned development approval shall provide information at three points in the city approval process. First, the applicant must submit to DPD, as part of its application for planned development approval, an M/WBE Participation Proposal. The M/WBE Participation Proposal must identify the applicant's goals for participation of certified M/WBE firms in the design, engineering and construction of the project, and of city residents in the construction work. The city encourages goals of (i) 26% MBE and 6% WBE participation (measured against the total construction budget for the project or any phase thereof), and (ii) 50% city resident hiring (measured against the total construction work hours for the project or any phase thereof). The M/WBE Participation Proposal must include a description of the Applicant's proposed outreach plan designed to inform M/WBEs and city residents of job and contracting opportunities. Second, at the time of the Applicant's submission for Part II permit review for the project or any phase thereof, the Applicant must submit to DPD (a) updates (if any) to the Applicant's preliminary outreach plan, (b) a description of the Applicant's outreach efforts and evidence of such outreach, including, without limitation, copies of certified letters to M/WBE contractor associations and the ward office of the alderman in which the project is located and receipts thereof; (c) responses to the Applicant's outreach efforts, and (d) updates (if any) to the applicant's M/WBE and city resident participation goals. Third, prior to issuance of a Certificate of Occupancy for the project or any phase thereof, the Applicant must provide

Applicants: Chicago Hope Academy/Chicago Lions Charitable Association
Address: 731-799 South Washtenaw/2605-59 West Harrison Street
Date of Introduction: September 18, 2019
Plan Commission.

DPD with the actual level of M/WBE and city resident participation in the project or any phase thereof, and evidence of such participation. In addition to the forgoing, DPD may request such additional information as the department determines may be necessary or useful in evaluating the extent to which M/WBEs and city residents are informed of and utilized in planned development projects. All such information will be provided in a form acceptable to the Zoning Administrator. DPD will report the data it collects regarding projected and actual employment of M/WBEs and city residents in planned development projects twice yearly to the Chicago Plan Commission and annually to the Chicago City Council and the Mayor.

18. This Planned Development shall be governed by Section 17-13-0612. Should this Planned Development ordinance lapse, the Zoning Administrator shall initiate a Zoning Map Amendment to rezone the property to C3-1 Community, Manufacturing and Employment District.

Applicants: Chicago Hope Academy/Chicago Lions Charitable Association
Address: 731-799 South Washtenaw/2605-59 West Harrison Street
Date of Introduction: September 18, 2019
Plan Commission

INSTITUTIONAL PLANNED DEVELOPMENT NO. _____
 BULK REGULATIONS AND DATA TABLE

Gross Site Area:	958,340 sq. ft.
Area of Public Right of Way:	98,969 sq. ft.
Net Site Area:	859,371 sq. ft.
Maximum Floor Area Ratio:	1.2
Allowed Uses:	All uses identified in Statement Number 5
Athletic Field Occupancy:	6,120 bleacher seats
No. of Off-street Parking Spaces:	612 spaces (as further defined below)
	Per PD approval (on-site):
	<ul style="list-style-type: none"> • Quest Lot (West) 50 Spaces • Quest Lot (East) 62 Spaces • Hope Lot (South) 91 Spaces • CLCA Lot (North-West) 75 Spaces • CLCA Lot (North-East) <u>9 Spaces</u> Total: 287 Spaces
	Per Special Use approval (off-site)
	<ul style="list-style-type: none"> • CLCA Lot (Apron City) 225 Spaces • CLCA Lot (Apron West) <u>100 Spaces</u> Total: 325 Spaces
Bicycle Parking:	1 per 10 auto spaces
No. of Loading Berths	1 (school)
Maximum Building Height:	54' (proposed school) 42' (proposed field house)
Minimum Setbacks:	In accordance with plans

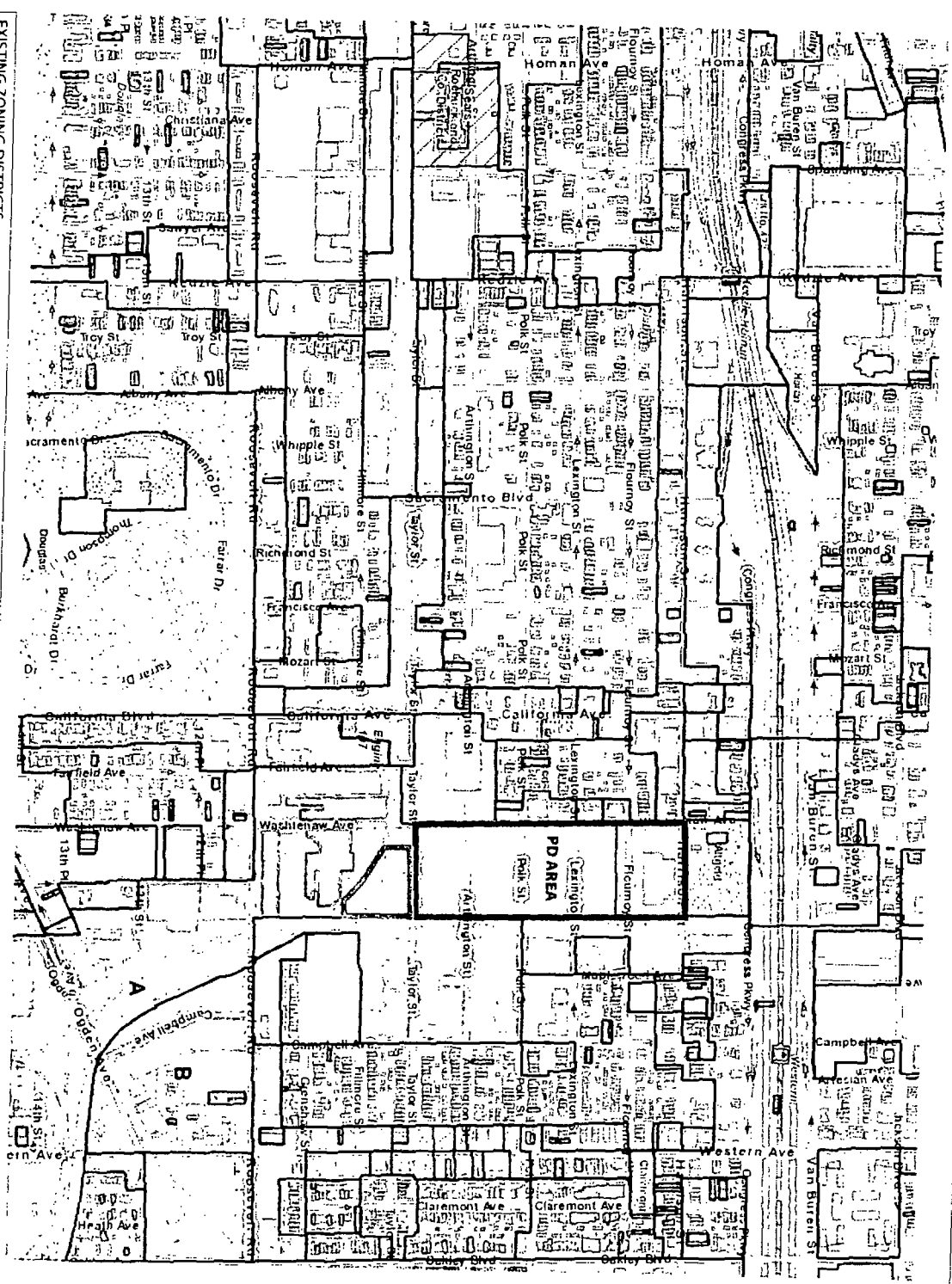

EXISTING ZONING DISTRICTS

MANUFACTURING

BUSINESS

RESIDENTIAL

PLANNED MANUFACTURING

COMMERCIAL

PARKS & OPEN SPACE

PD BOUNDARY

SPECIAL USE (SEPARATE APPLICATION)

G008

CHICAGO HOPE ACADEMY + CHICAGO LIONS CHARITABLE ASSOCIATION

731-799 S Washlennaw Ave.,
Chicago, IL 60612

DATE: 11/11/11
 DRAWN BY: J. B. ...
 CHECKED BY: ...
 APPROVED BY: ...

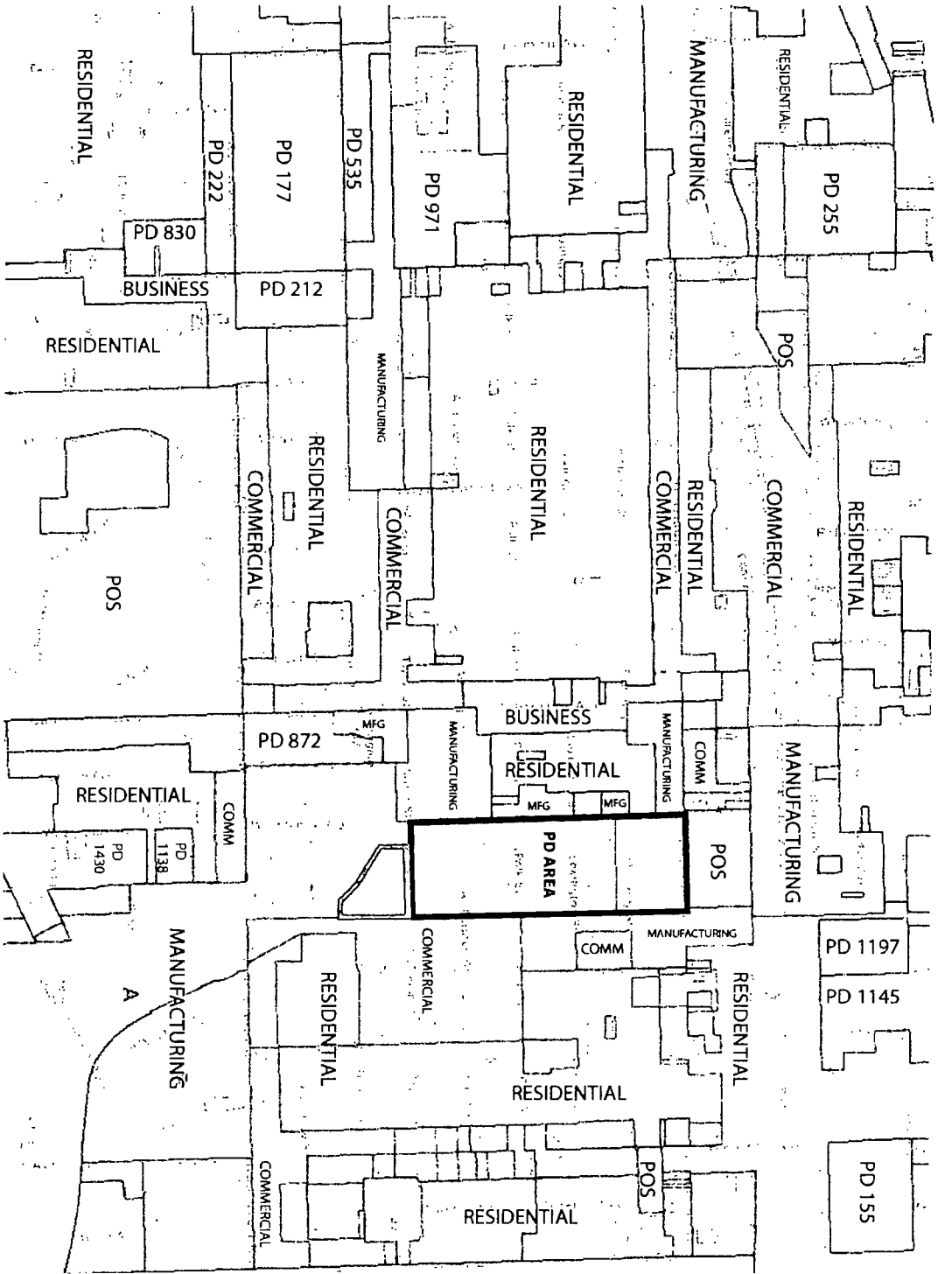

- PD BOUNDARY
- SPECIAL USE
(SEPARATE APPLICATION)

EXISTING LAND USE
G009

731-799 S Washburn Ave.
Chicago, IL 60612

CHICAGO HOPE ACADEMY + CHICAGO LIONS CHARITABLE ASSOCIATION

NO.	DESCRIPTION	DATE
1	PRELIMINARY	12/15/11
2	REVISED	01/10/12
3	REVISED	02/01/12
4	REVISED	02/01/12
5	REVISED	02/01/12
6	REVISED	02/01/12
7	REVISED	02/01/12
8	REVISED	02/01/12
9	REVISED	02/01/12
10	REVISED	02/01/12
11	REVISED	02/01/12
12	REVISED	02/01/12
13	REVISED	02/01/12
14	REVISED	02/01/12
15	REVISED	02/01/12
16	REVISED	02/01/12
17	REVISED	02/01/12
18	REVISED	02/01/12
19	REVISED	02/01/12
20	REVISED	02/01/12

NO.	DESCRIPTION	DATE
1	PRELIMINARY	12/15/11
2	REVISED	01/10/12
3	REVISED	02/01/12
4	REVISED	02/01/12
5	REVISED	02/01/12
6	REVISED	02/01/12
7	REVISED	02/01/12
8	REVISED	02/01/12
9	REVISED	02/01/12
10	REVISED	02/01/12
11	REVISED	02/01/12
12	REVISED	02/01/12
13	REVISED	02/01/12
14	REVISED	02/01/12
15	REVISED	02/01/12
16	REVISED	02/01/12
17	REVISED	02/01/12
18	REVISED	02/01/12
19	REVISED	02/01/12
20	REVISED	02/01/12

7

W 1/2 SE 1/4 SEC. 13-39-13

PD BOUNDARY

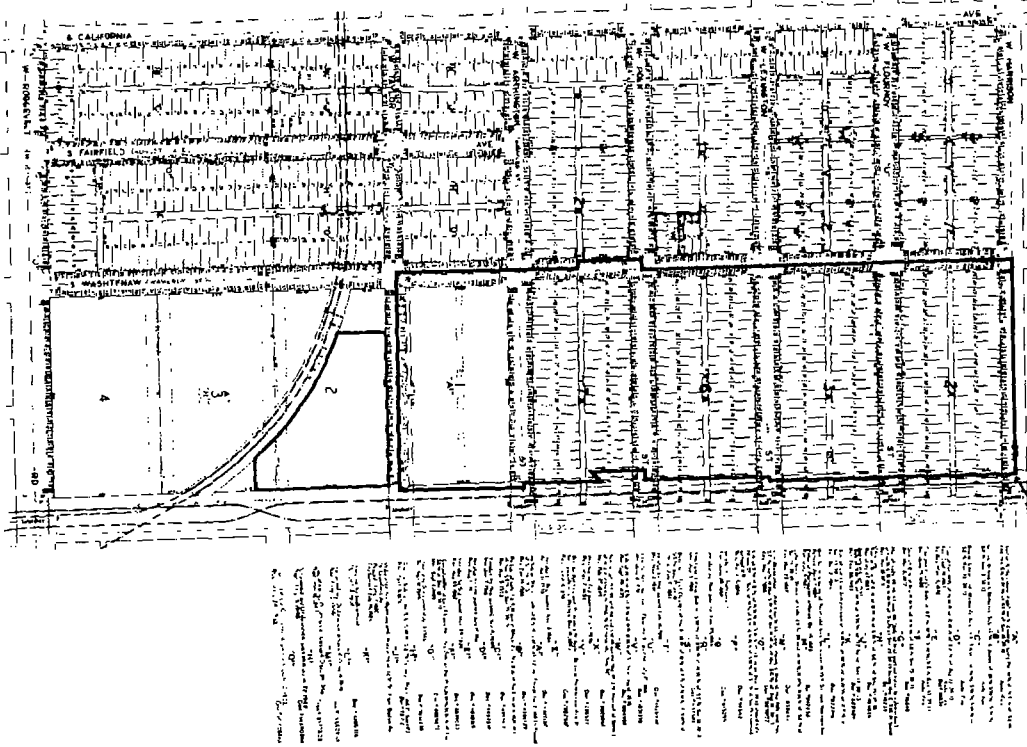

PLAT OF SURVEY

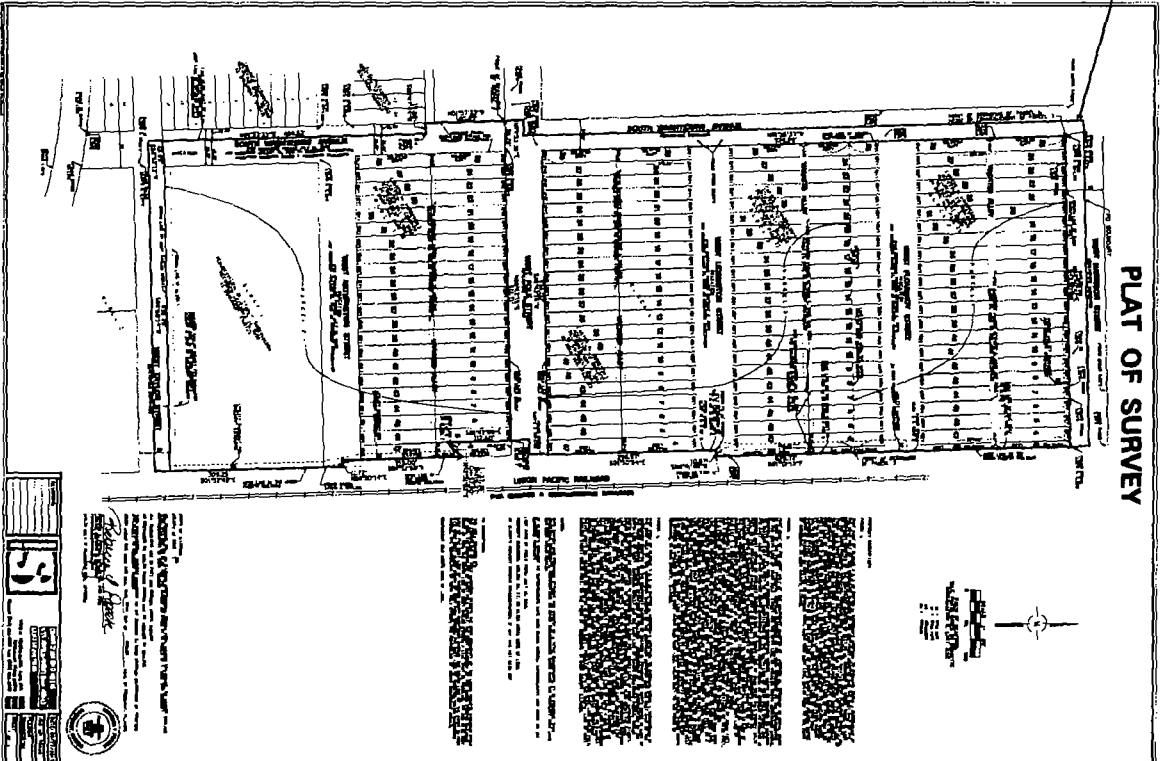

- PD BOUNDARY
- SPECIAL USE (SEPARATE APPLICATION)

PLANNED DEVELOPMENT
BOUNDARY

G010

CHICAGO HOPE ACADEMY + CHICAGO LIONS CHARITABLE ASSOCIATION
731-799 S Washtienaw Avb.
Chicago, IL 60612

CHICAGO PLANNED DEVELOPMENT

PLANNED DEVELOPMENT

CHICAGO PLANNED DEVELOPMENT

CHICAGO PLANNED DEVELOPMENT

DATE: 11/11/2011

PROJECT: CHICAGO HOPE ACADEMY + CHICAGO LIONS CHARITABLE ASSOCIATION

FILE NO: 11111111

SCALE: 1" = 100'

DATE: 11/11/2011

PROJECT: CHICAGO HOPE ACADEMY + CHICAGO LIONS CHARITABLE ASSOCIATION

FILE NO: 11111111

SCALE: 1" = 100'

PROJECT INFORMATION		DATE	
PROJECT NAME	CHICAGO HOPE ACADEMY + CHICAGO LIONS CHARITABLE ASSOCIATION	DATE	11/15/2011
PROJECT ADDRESS	731-799 S WASHINGTON AVE., CHICAGO, IL 60612	DATE	11/15/2011
PROJECT TYPE	RENOVATION	DATE	11/15/2011
PROJECT OWNER	CHICAGO HOPE ACADEMY + CHICAGO LIONS CHARITABLE ASSOCIATION	DATE	11/15/2011
PROJECT ARCHITECT	ARCHITECTURE	DATE	11/15/2011
PROJECT ENGINEER	ENGINEERING	DATE	11/15/2011
PROJECT CONTRACTOR	CONSTRUCTION	DATE	11/15/2011
PROJECT PERMITTING	PERMITTING	DATE	11/15/2011
PROJECT CONSULTANTS	CONSULTANTS	DATE	11/15/2011
PROJECT NOTES	NOTES	DATE	11/15/2011

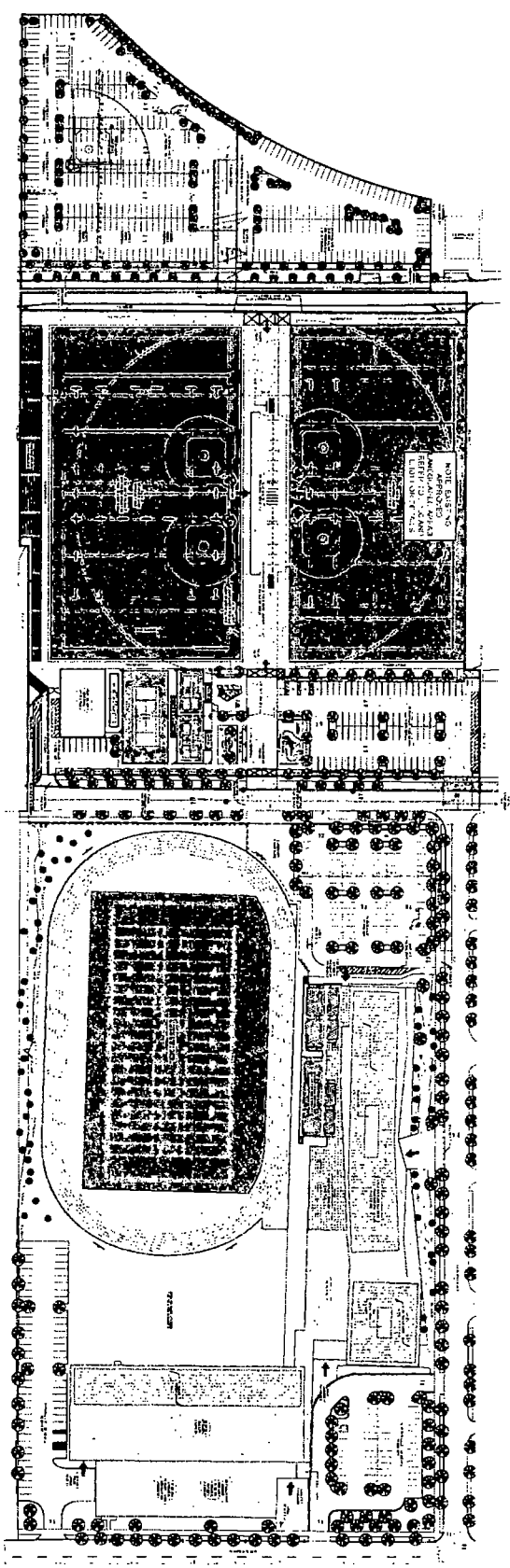

PROPOSED OVERALL SITE PLAN AND ELEVATION

A100

CHICAGO HOPE ACADEMY + CHICAGO LIONS CHARITABLE ASSOCIATION
 731-799 S WASHINGTON AVE.,
 Chicago, IL 60612

NO.	REVISION	DATE
1	ISSUED FOR PERMITTING	11/15/2011
2	ISSUED FOR PERMITTING	11/15/2011
3	ISSUED FOR PERMITTING	11/15/2011
4	ISSUED FOR PERMITTING	11/15/2011
5	ISSUED FOR PERMITTING	11/15/2011
6	ISSUED FOR PERMITTING	11/15/2011
7	ISSUED FOR PERMITTING	11/15/2011
8	ISSUED FOR PERMITTING	11/15/2011
9	ISSUED FOR PERMITTING	11/15/2011
10	ISSUED FOR PERMITTING	11/15/2011

PROPOSED SITE PLAN NORTH
 (HAZ) A101

DATE	11/11/11
BY	...
REVISION	...

CHICAGO HOPE ACADEMY + CHICAGO LIONS CHARITABLE ASSOCIATION
 731-799 S Washnaw Ave.
 Chicago, IL 60612

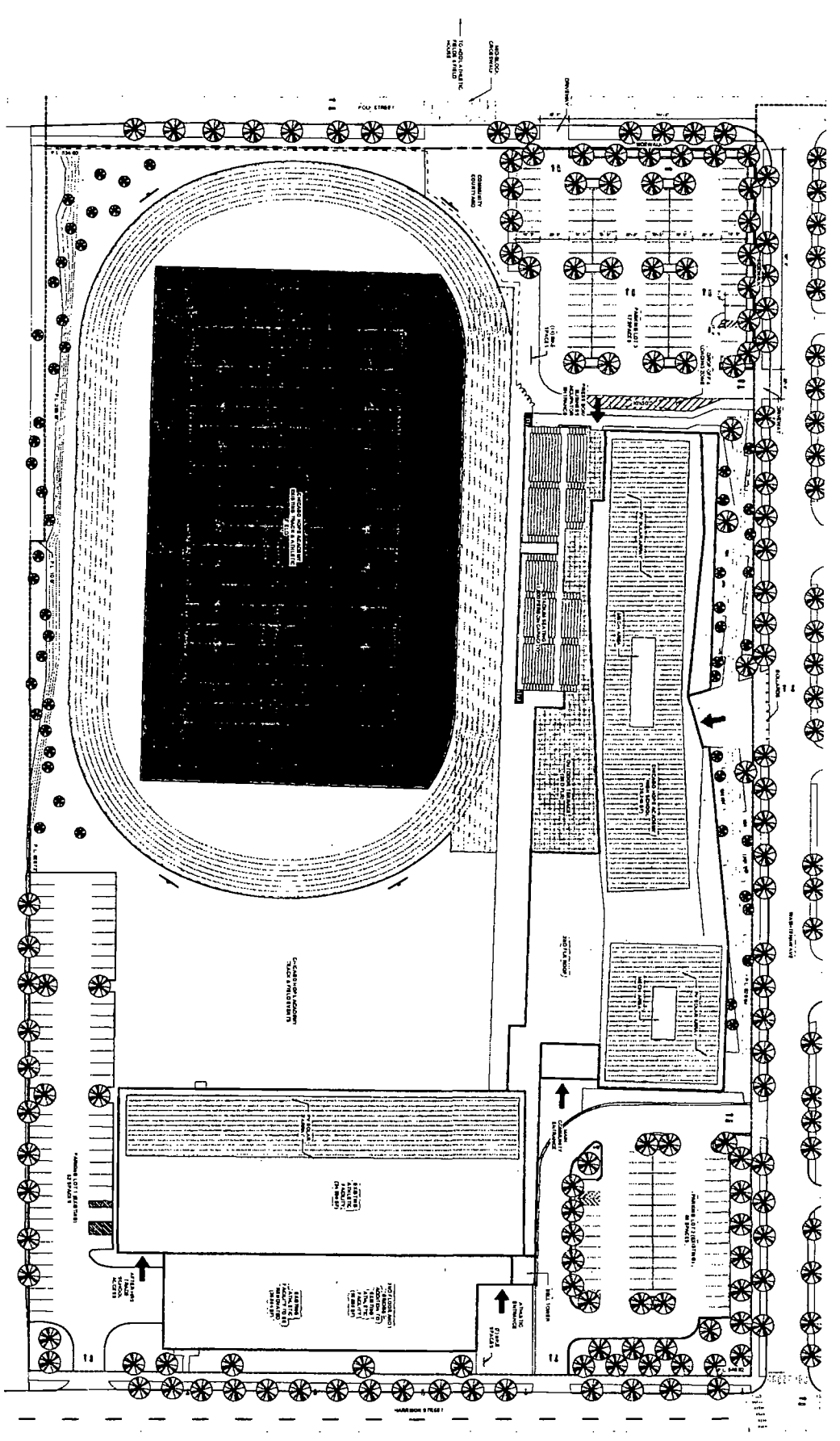

LANDSCAPING NOTES
 ALL LANDSCAPING TO BE INSTALLED BY THE CONTRACTOR. THE CONTRACTOR SHALL BE RESPONSIBLE FOR OBTAINING ALL NECESSARY PERMITS AND APPROVALS FROM THE CITY OF CHICAGO AND THE ILLINOIS DEPARTMENT OF TRANSPORTATION. THE CONTRACTOR SHALL BE RESPONSIBLE FOR OBTAINING ALL NECESSARY PERMITS AND APPROVALS FROM THE CITY OF CHICAGO AND THE ILLINOIS DEPARTMENT OF TRANSPORTATION. THE CONTRACTOR SHALL BE RESPONSIBLE FOR OBTAINING ALL NECESSARY PERMITS AND APPROVALS FROM THE CITY OF CHICAGO AND THE ILLINOIS DEPARTMENT OF TRANSPORTATION.

ITEM	DESCRIPTION	QUANTITY	UNIT
1
2
3

ITEM	DESCRIPTION	QUANTITY	UNIT
4
5
6

ITEM	DESCRIPTION	QUANTITY	UNIT
7
8
9

CHICAGO HOPE ACADEMY + CHICAGO LIONS CHARITABLE ASSOCIATION
 731-799 S Washnaw Ave.
 Chicago, IL 60612

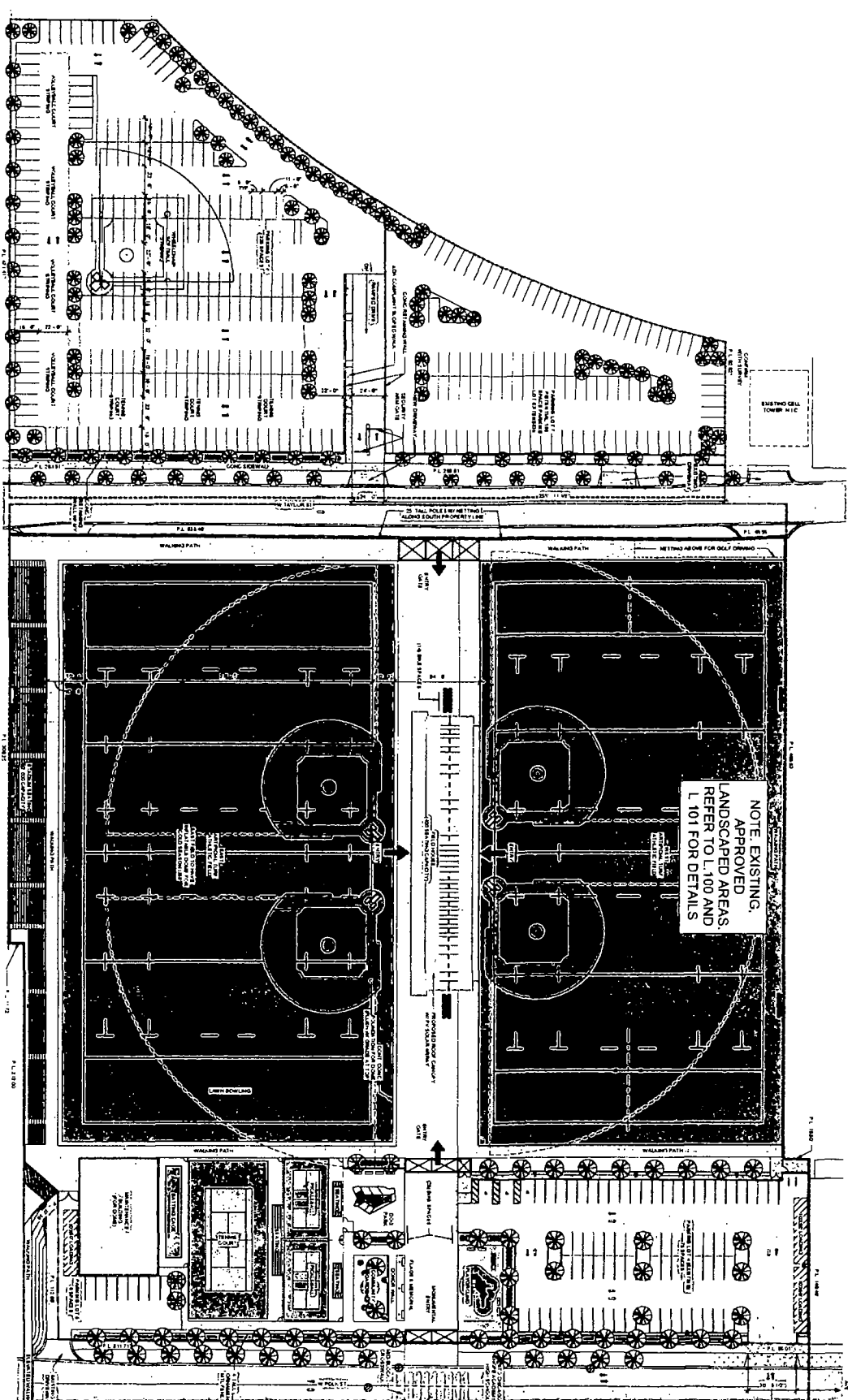

PROPOSED SITE PLAN (SOUTH HALF)

LANDSCAPING NOTES

1. ALL LANDSCAPING SHALL BE IN ACCORDANCE WITH THE CITY OF CHICAGO'S LANDSCAPING ORDINANCES AND THE CITY OF CHICAGO'S LANDSCAPING DESIGN MANUAL.

2. ALL TREES SHALL BE PLANTED AT THE PROPER SPACING AND DEPTH TO GROW TOGETHER WITH THE EXISTING TREES.

3. ALL TREES SHALL BE PLANTED AT THE PROPER SPACING AND DEPTH TO GROW TOGETHER WITH THE EXISTING TREES.

4. ALL TREES SHALL BE PLANTED AT THE PROPER SPACING AND DEPTH TO GROW TOGETHER WITH THE EXISTING TREES.

INTERIOR FINISHING AND CORE REQUIREMENTS

FINISH	REQUIREMENTS	FINISH	REQUIREMENTS
1. FLOOR	1. POLISHED CONCRETE	1. FLOOR	1. POLISHED CONCRETE
2. WALLS	2. GYPSONUM BOARD	2. WALLS	2. GYPSONUM BOARD
3. CEILING	3. GYPSONUM BOARD	3. CEILING	3. GYPSONUM BOARD
4. DOORS	4. 1 1/2" MIN. THICK	4. DOORS	4. 1 1/2" MIN. THICK
5. WINDOWS	5. 1 1/2" MIN. THICK	5. WINDOWS	5. 1 1/2" MIN. THICK
6. PARTITION WALLS	6. 1 1/2" MIN. THICK	6. PARTITION WALLS	6. 1 1/2" MIN. THICK
7. CORE	7. 1 1/2" MIN. THICK	7. CORE	7. 1 1/2" MIN. THICK
8. CORE	8. 1 1/2" MIN. THICK	8. CORE	8. 1 1/2" MIN. THICK

LEGEND

SYMBOL	DESCRIPTION
[Symbol]	EXISTING TREES
[Symbol]	PROPOSED TREES
[Symbol]	PROPOSED LANDSCAPING
[Symbol]	PROPOSED PATHS
[Symbol]	PROPOSED WALLS
[Symbol]	PROPOSED DOORS
[Symbol]	PROPOSED WINDOWS
[Symbol]	PROPOSED CORE

PROPOSED SITE PLAN (SOUTH HALF)
 A102

CHICAGO HOPE ACADEMY + CHICAGO LIONS CHARITABLE ASSOCIATION

2637 W Polk Street
 Chicago, IL 60612

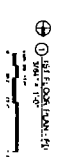

FLOOR PLANS - CHICAGO HOPE ACADEMY

A104

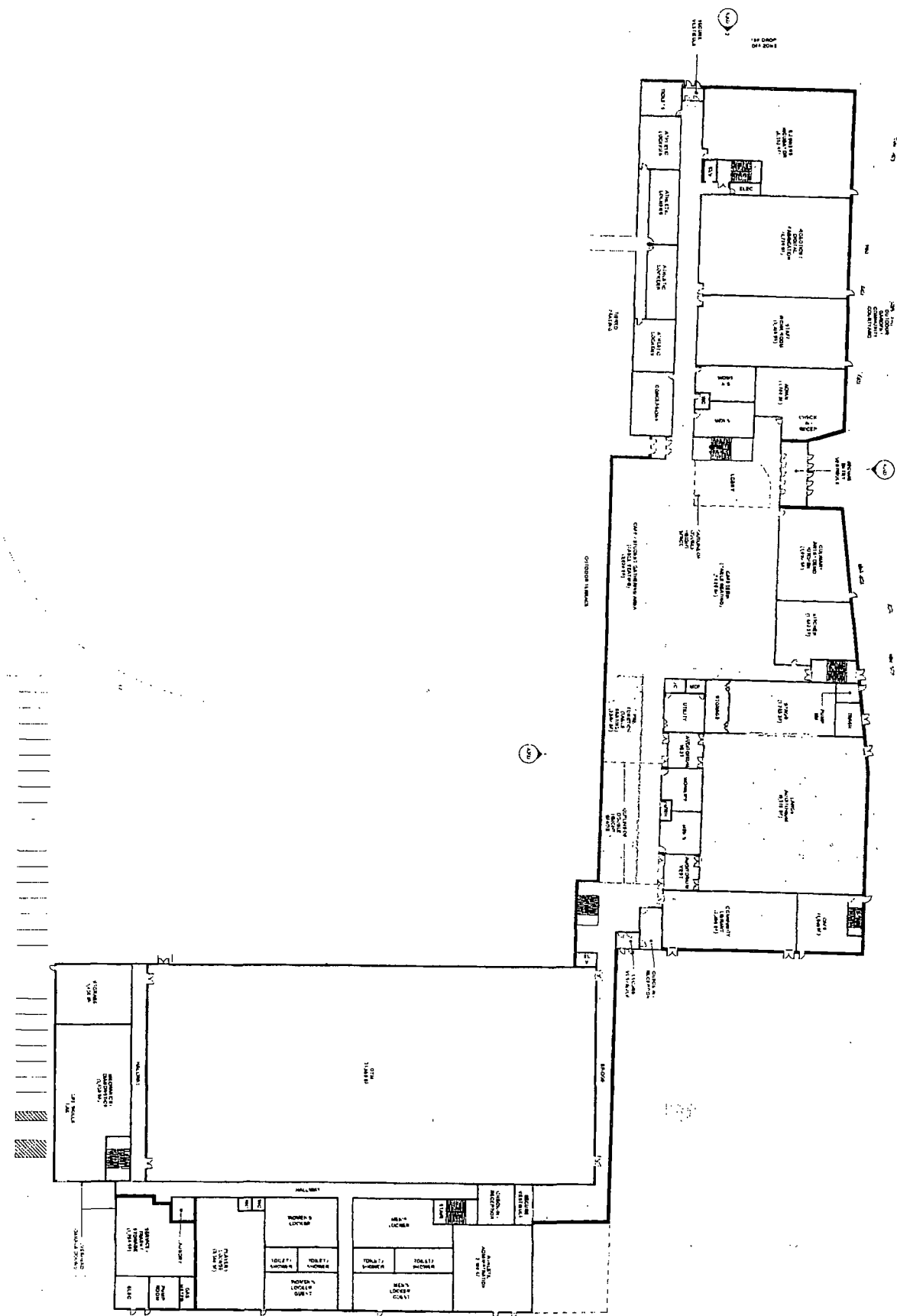

NO.	DESCRIPTION	DATE
1	AS BUILT	11/14/03
2	REVISION	11/14/03
3	REVISION	11/14/03
4	REVISION	11/14/03
5	REVISION	11/14/03
6	REVISION	11/14/03
7	REVISION	11/14/03
8	REVISION	11/14/03
9	REVISION	11/14/03
10	REVISION	11/14/03

CHICAGO HOPE ACADEMY + CHICAGO LIONS CHARITABLE ASSOCIATION
 731-799 S Washenaw Ave.
 Chicago, IL 60612

NO.	DESCRIPTION	DATE
1	AS BUILT	11/14/03
2	REVISION	11/14/03
3	REVISION	11/14/03
4	REVISION	11/14/03
5	REVISION	11/14/03
6	REVISION	11/14/03
7	REVISION	11/14/03
8	REVISION	11/14/03
9	REVISION	11/14/03
10	REVISION	11/14/03

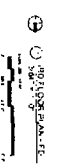
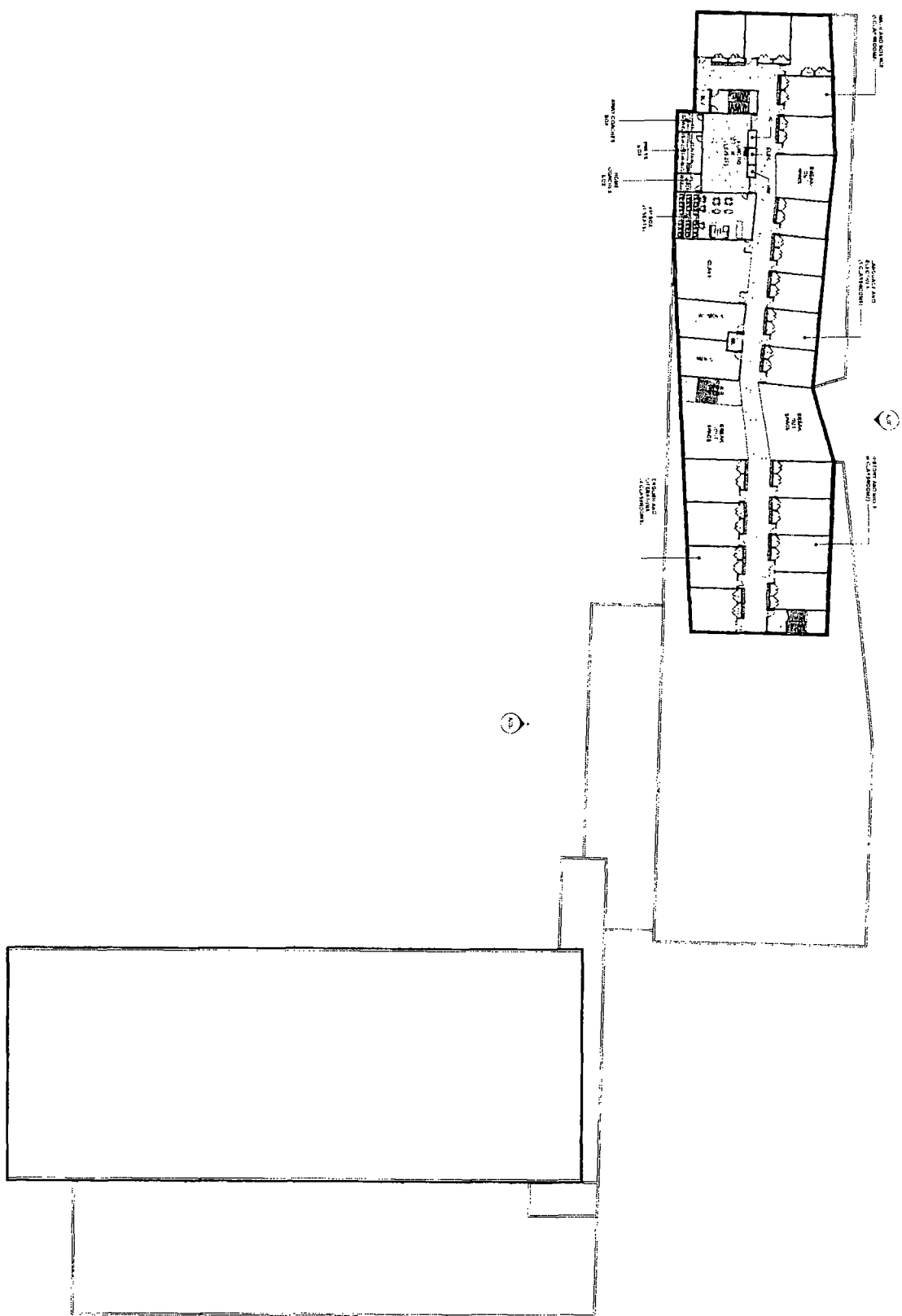

FLOOR PLANS - CHICAGO HOPE
ACADEMY

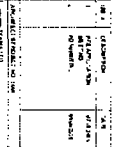

CHICAGO HOPE ACADEMY + CHICAGO LIONS CHARITABLE ASSOCIATION
731-799 S Washburn Ave.,
Chicago, IL 60612

OWNER: CHICAGO HOPE ACADEMY + CHICAGO LIONS CHARITABLE ASSOCIATION
ARCHITECT: [Faint text]
DATE: [Faint text]

FLOOR PLANS - CHICAGO HOPE
ACADEMY

NO.	DESCRIPTION	DATE
1	REVISIONS	
2	REVISIONS	
3	REVISIONS	
4	REVISIONS	
5	REVISIONS	
6	REVISIONS	
7	REVISIONS	
8	REVISIONS	
9	REVISIONS	
10	REVISIONS	

CHICAGO HOPE ACADEMY + CHICAGO LIONS CHARITABLE ASSOCIATION
731-799 S Washburn Ave.,
Chicago, IL 60612

DATE: 11/17/2011
PROJECT: CHICAGO HOPE ACADEMY + CHICAGO LIONS CHARITABLE ASSOCIATION
DRAWN BY: [Name]
CHECKED BY: [Name]
SCALE: 1/8" = 1'-0"

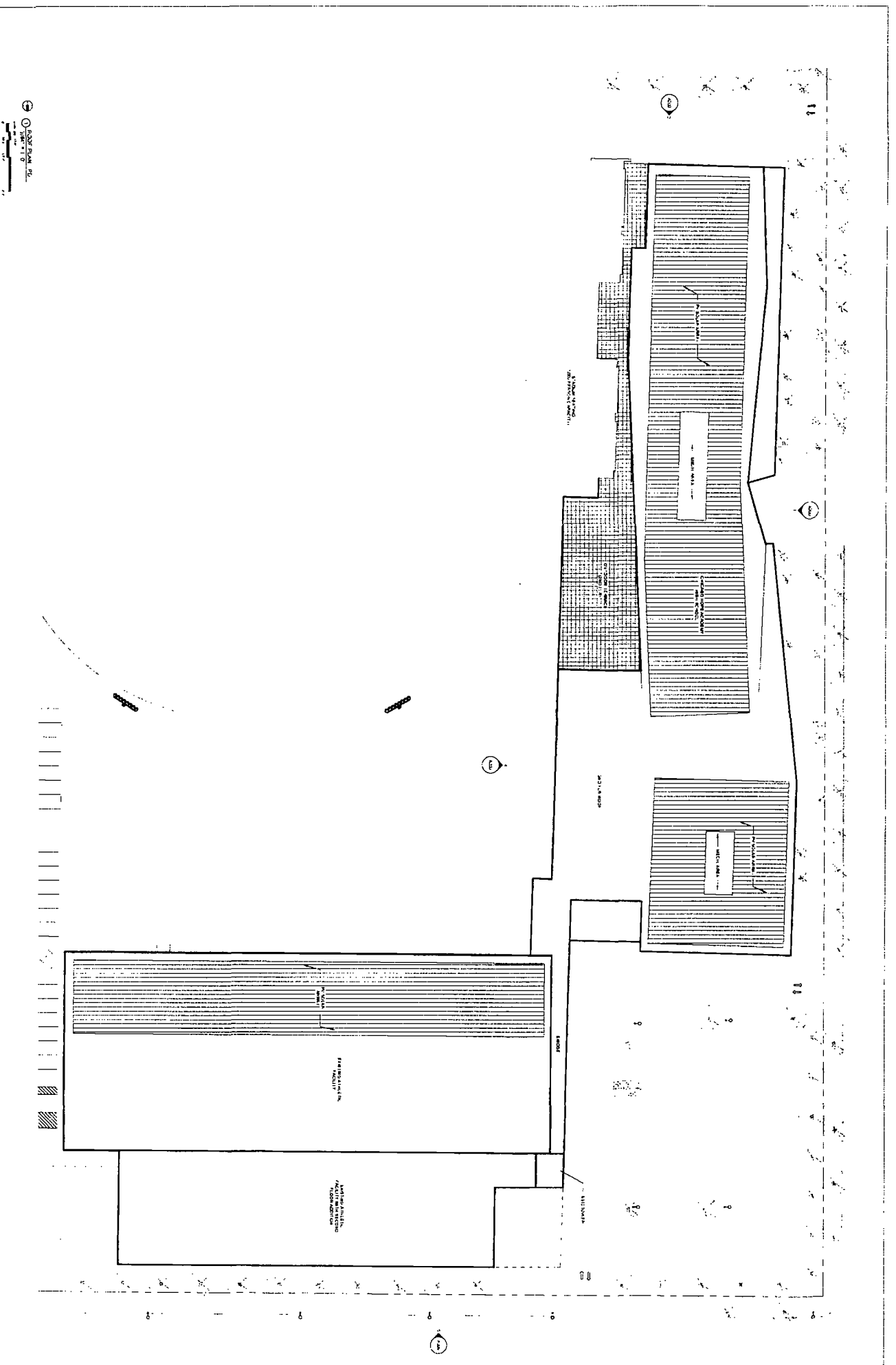

FLOOR PLANS - CLCA
FIELDHOUSE
A108

NO.	DESCRIPTION	DATE
1	PRELIMINARY	11/24/87
2	REVISED	12/15/87
3	REVISED	1/15/88
4	REVISED	2/15/88
5	REVISED	3/15/88
6	REVISED	4/15/88
7	REVISED	5/15/88
8	REVISED	6/15/88
9	REVISED	7/15/88
10	REVISED	8/15/88
11	REVISED	9/15/88
12	REVISED	10/15/88
13	REVISED	11/15/88
14	REVISED	12/15/88
15	REVISED	1/15/89
16	REVISED	2/15/89
17	REVISED	3/15/89
18	REVISED	4/15/89
19	REVISED	5/15/89
20	REVISED	6/15/89
21	REVISED	7/15/89
22	REVISED	8/15/89
23	REVISED	9/15/89
24	REVISED	10/15/89
25	REVISED	11/15/89
26	REVISED	12/15/89
27	REVISED	1/15/90
28	REVISED	2/15/90
29	REVISED	3/15/90
30	REVISED	4/15/90
31	REVISED	5/15/90
32	REVISED	6/15/90
33	REVISED	7/15/90
34	REVISED	8/15/90
35	REVISED	9/15/90
36	REVISED	10/15/90
37	REVISED	11/15/90
38	REVISED	12/15/90
39	REVISED	1/15/91
40	REVISED	2/15/91
41	REVISED	3/15/91
42	REVISED	4/15/91
43	REVISED	5/15/91
44	REVISED	6/15/91
45	REVISED	7/15/91
46	REVISED	8/15/91
47	REVISED	9/15/91
48	REVISED	10/15/91
49	REVISED	11/15/91
50	REVISED	12/15/91
51	REVISED	1/15/92
52	REVISED	2/15/92
53	REVISED	3/15/92
54	REVISED	4/15/92
55	REVISED	5/15/92
56	REVISED	6/15/92
57	REVISED	7/15/92
58	REVISED	8/15/92
59	REVISED	9/15/92
60	REVISED	10/15/92
61	REVISED	11/15/92
62	REVISED	12/15/92
63	REVISED	1/15/93
64	REVISED	2/15/93
65	REVISED	3/15/93
66	REVISED	4/15/93
67	REVISED	5/15/93
68	REVISED	6/15/93
69	REVISED	7/15/93
70	REVISED	8/15/93
71	REVISED	9/15/93
72	REVISED	10/15/93
73	REVISED	11/15/93
74	REVISED	12/15/93
75	REVISED	1/15/94
76	REVISED	2/15/94
77	REVISED	3/15/94
78	REVISED	4/15/94
79	REVISED	5/15/94
80	REVISED	6/15/94
81	REVISED	7/15/94
82	REVISED	8/15/94
83	REVISED	9/15/94
84	REVISED	10/15/94
85	REVISED	11/15/94
86	REVISED	12/15/94
87	REVISED	1/15/95
88	REVISED	2/15/95
89	REVISED	3/15/95
90	REVISED	4/15/95
91	REVISED	5/15/95
92	REVISED	6/15/95
93	REVISED	7/15/95
94	REVISED	8/15/95
95	REVISED	9/15/95
96	REVISED	10/15/95
97	REVISED	11/15/95
98	REVISED	12/15/95
99	REVISED	1/15/96
100	REVISED	2/15/96
101	REVISED	3/15/96
102	REVISED	4/15/96
103	REVISED	5/15/96
104	REVISED	6/15/96
105	REVISED	7/15/96
106	REVISED	8/15/96
107	REVISED	9/15/96
108	REVISED	10/15/96
109	REVISED	11/15/96
110	REVISED	12/15/96
111	REVISED	1/15/97
112	REVISED	2/15/97
113	REVISED	3/15/97
114	REVISED	4/15/97
115	REVISED	5/15/97
116	REVISED	6/15/97
117	REVISED	7/15/97
118	REVISED	8/15/97
119	REVISED	9/15/97
120	REVISED	10/15/97
121	REVISED	11/15/97
122	REVISED	12/15/97
123	REVISED	1/15/98
124	REVISED	2/15/98
125	REVISED	3/15/98
126	REVISED	4/15/98
127	REVISED	5/15/98
128	REVISED	6/15/98
129	REVISED	7/15/98
130	REVISED	8/15/98
131	REVISED	9/15/98
132	REVISED	10/15/98
133	REVISED	11/15/98
134	REVISED	12/15/98
135	REVISED	1/15/99
136	REVISED	2/15/99
137	REVISED	3/15/99
138	REVISED	4/15/99
139	REVISED	5/15/99
140	REVISED	6/15/99
141	REVISED	7/15/99
142	REVISED	8/15/99
143	REVISED	9/15/99
144	REVISED	10/15/99
145	REVISED	11/15/99
146	REVISED	12/15/99
147	REVISED	1/15/00
148	REVISED	2/15/00
149	REVISED	3/15/00
150	REVISED	4/15/00
151	REVISED	5/15/00
152	REVISED	6/15/00
153	REVISED	7/15/00
154	REVISED	8/15/00
155	REVISED	9/15/00
156	REVISED	10/15/00
157	REVISED	11/15/00
158	REVISED	12/15/00
159	REVISED	1/15/01
160	REVISED	2/15/01
161	REVISED	3/15/01
162	REVISED	4/15/01
163	REVISED	5/15/01
164	REVISED	6/15/01
165	REVISED	7/15/01
166	REVISED	8/15/01
167	REVISED	9/15/01
168	REVISED	10/15/01
169	REVISED	11/15/01
170	REVISED	12/15/01
171	REVISED	1/15/02
172	REVISED	2/15/02
173	REVISED	3/15/02
174	REVISED	4/15/02
175	REVISED	5/15/02
176	REVISED	6/15/02
177	REVISED	7/15/02
178	REVISED	8/15/02
179	REVISED	9/15/02
180	REVISED	10/15/02
181	REVISED	11/15/02
182	REVISED	12/15/02
183	REVISED	1/15/03
184	REVISED	2/15/03
185	REVISED	3/15/03
186	REVISED	4/15/03
187	REVISED	5/15/03
188	REVISED	6/15/03
189	REVISED	7/15/03
190	REVISED	8/15/03
191	REVISED	9/15/03
192	REVISED	10/15/03
193	REVISED	11/15/03
194	REVISED	12/15/03
195	REVISED	1/15/04
196	REVISED	2/15/04
197	REVISED	3/15/04
198	REVISED	4/15/04
199	REVISED	5/15/04
200	REVISED	6/15/04
201	REVISED	7/15/04
202	REVISED	8/15/04
203	REVISED	9/15/04
204	REVISED	10/15/04
205	REVISED	11/15/04
206	REVISED	12/15/04
207	REVISED	1/15/05
208	REVISED	2/15/05
209	REVISED	3/15/05
210	REVISED	4/15/05
211	REVISED	5/15/05
212	REVISED	6/15/05
213	REVISED	7/15/05
214	REVISED	8/15/05
215	REVISED	9/15/05
216	REVISED	10/15/05
217	REVISED	11/15/05
218	REVISED	12/15/05
219	REVISED	1/15/06
220	REVISED	2/15/06
221	REVISED	3/15/06
222	REVISED	4/15/06
223	REVISED	5/15/06
224	REVISED	6/15/06
225	REVISED	7/15/06
226	REVISED	8/15/06
227	REVISED	9/15/06
228	REVISED	10/15/06
229	REVISED	11/15/06
230	REVISED	12/15/06
231	REVISED	1/15/07
232	REVISED	2/15/07
233	REVISED	3/15/07
234	REVISED	4/15/07
235	REVISED	5/15/07
236	REVISED	6/15/07
237	REVISED	7/15/07
238	REVISED	8/15/07
239	REVISED	9/15/07
240	REVISED	10/15/07
241	REVISED	11/15/07
242	REVISED	12/15/07
243	REVISED	1/15/08
244	REVISED	2/15/08
245	REVISED	3/15/08
246	REVISED	4/15/08
247	REVISED	5/15/08
248	REVISED	6/15/08
249	REVISED	7/15/08
250	REVISED	8/15/08
251	REVISED	9/15/08
252	REVISED	10/15/08
253	REVISED	11/15/08
254	REVISED	12/15/08
255	REVISED	1/15/09
256	REVISED	2/15/09
257	REVISED	3/15/09
258	REVISED	4/15/09
259	REVISED	5/15/09
260	REVISED	6/15/09
261	REVISED	7/15/09
262	REVISED	8/15/09
263	REVISED	9/15/09
264	REVISED	10/15/09
265	REVISED	11/15/09
266	REVISED	12/15/09
267	REVISED	1/15/10
268	REVISED	2/15/10
269	REVISED	3/15/10
270	REVISED	4/15/10
271	REVISED	5/15/10
272	REVISED	6/15/10
273	REVISED	7/15/10
274	REVISED	8/15/10
275	REVISED	9/15/10
276	REVISED	10/15/10
277	REVISED	11/15/10
278	REVISED	12/15/10
279	REVISED	1/15/11
280	REVISED	2/15/11
281	REVISED	3/15/11
282	REVISED	4/15/11
283	REVISED	5/15/11
284	REVISED	6/15/11
285	REVISED	7/15/11
286	REVISED	8/15/11
287	REVISED	9/15/11
288	REVISED	10/15/11
289	REVISED	11/15/11
290	REVISED	12/15/11
291	REVISED	1/15/12
292	REVISED	2/15/12
293	REVISED	3/15/12
294	REVISED	4/15/12
295	REVISED	5/15/12
296	REVISED	6/15/12
297	REVISED	7/15/12
298	REVISED	8/15/12
299	REVISED	9/15/12
300	REVISED	10/15/12
301	REVISED	11/15/12
302	REVISED	12/15/12
303	REVISED	1/15/13
304	REVISED	2/15/13
305	REVISED	3/15/13
306	REVISED	4/15/13
307	REVISED	5/15/13
308	REVISED	6/15/13
309	REVISED	7/15/13
310	REVISED	8/15/13
311	REVISED	9/15/13
312	REVISED	10/15/13
313	REVISED	11/15/13
314	REVISED	12/15/13
315	REVISED	1/15/14
316	REVISED	2/15/14
317	REVISED	3/15/14
318	REVISED	4/15/14
319	REVISED	5/15/14
320	REVISED	6/15/14
321	REVISED	7/15/14
322	REVISED	8/15/14
323	REVISED	9/15/14
324	REVISED	10/15/14
325	REVISED	11/15/14
326	REVISED	12/15/14
327	REVISED	1/15/15
328	REVISED	2/15/15
329	REVISED	3/15/15
330	REVISED	4/15/15
331	REVISED	5/15/15
332	REVISED	6/15/15</

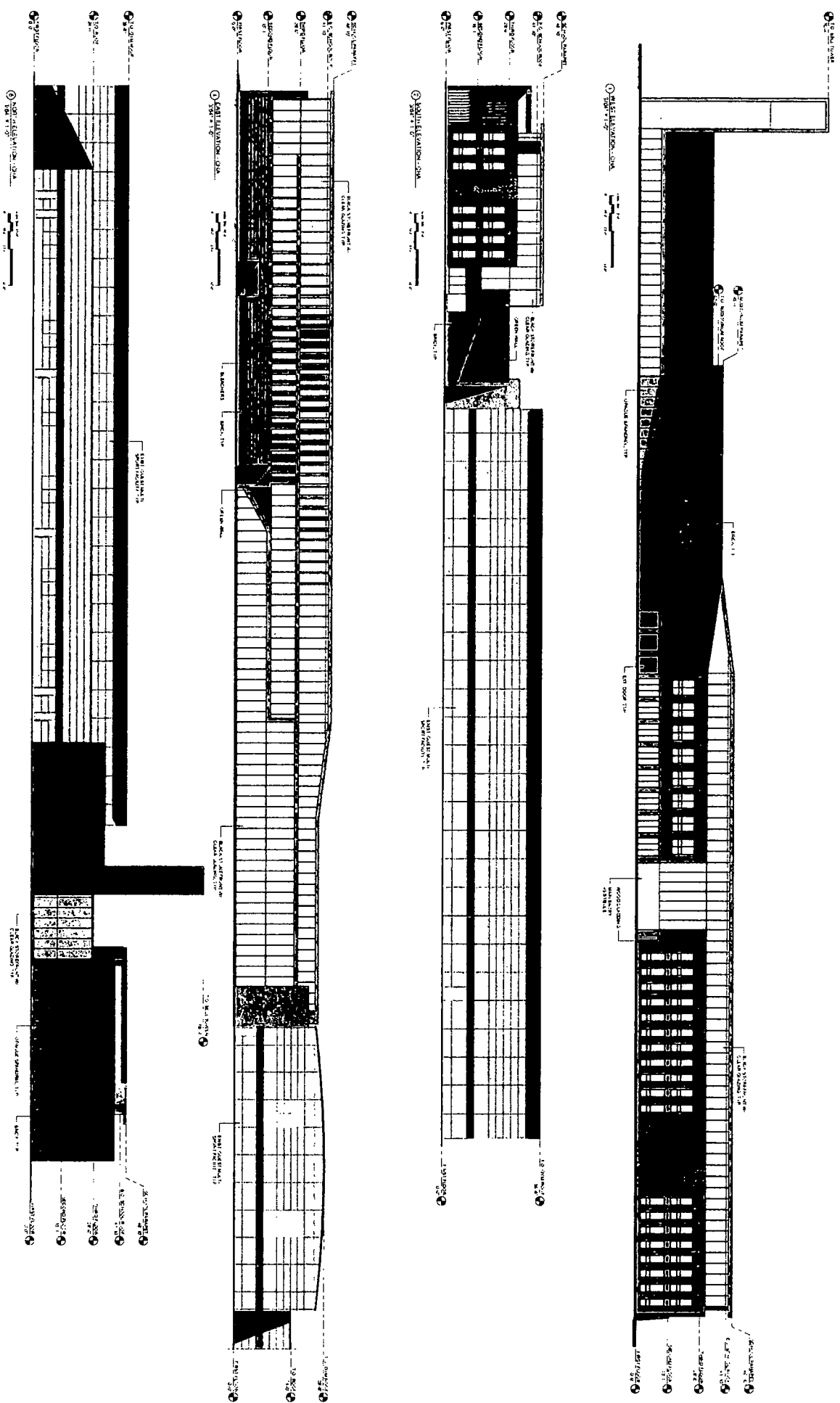

ELEVATIONS - CHICAGO HOPE ACADEMY

A200

NO.	DATE	DESCRIPTION	BY
1	10/15/11	FOR PERMIT	MM
2	11/15/11	FOR PERMIT	MM
3	12/15/11	FOR PERMIT	MM

CHICAGO HOPE ACADEMY + CHICAGO LIONS CHARITABLE ASSOCIATION
 731-799 S Washenaw Ave.,
 Chicago, IL 60612

NO.	DATE	DESCRIPTION	BY
1	10/15/11	FOR PERMIT	MM
2	11/15/11	FOR PERMIT	MM
3	12/15/11	FOR PERMIT	MM

ELEVATIONS - CLCA
 FIELDHOUSE
A201

NO. 1	DATE	DESCRIPTION	BY
1	12/1/14	REVISED PER COMMENTS	MM
2	12/1/14	REVISED PER COMMENTS	MM
3	12/1/14	REVISED PER COMMENTS	MM
4	12/1/14	REVISED PER COMMENTS	MM
5	12/1/14	REVISED PER COMMENTS	MM
6	12/1/14	REVISED PER COMMENTS <td>MM</td>	MM

CHICAGO HOPE ACADEMY + CHICAGO LIONS CHARITABLE ASSOCIATION
 2637 W Polk Street
 Chicago, IL 60612

DATE	DESCRIPTION	BY
12/1/14	REVISED PER COMMENTS	MM
12/1/14	REVISED PER COMMENTS	MM
12/1/14	REVISED PER COMMENTS	MM
12/1/14	REVISED PER COMMENTS	MM
12/1/14	REVISED PER COMMENTS	MM
12/1/14	REVISED PER COMMENTS	MM
12/1/14	REVISED PER COMMENTS	MM
12/1/14	REVISED PER COMMENTS	MM
12/1/14	REVISED PER COMMENTS	MM
12/1/14	REVISED PER COMMENTS	MM

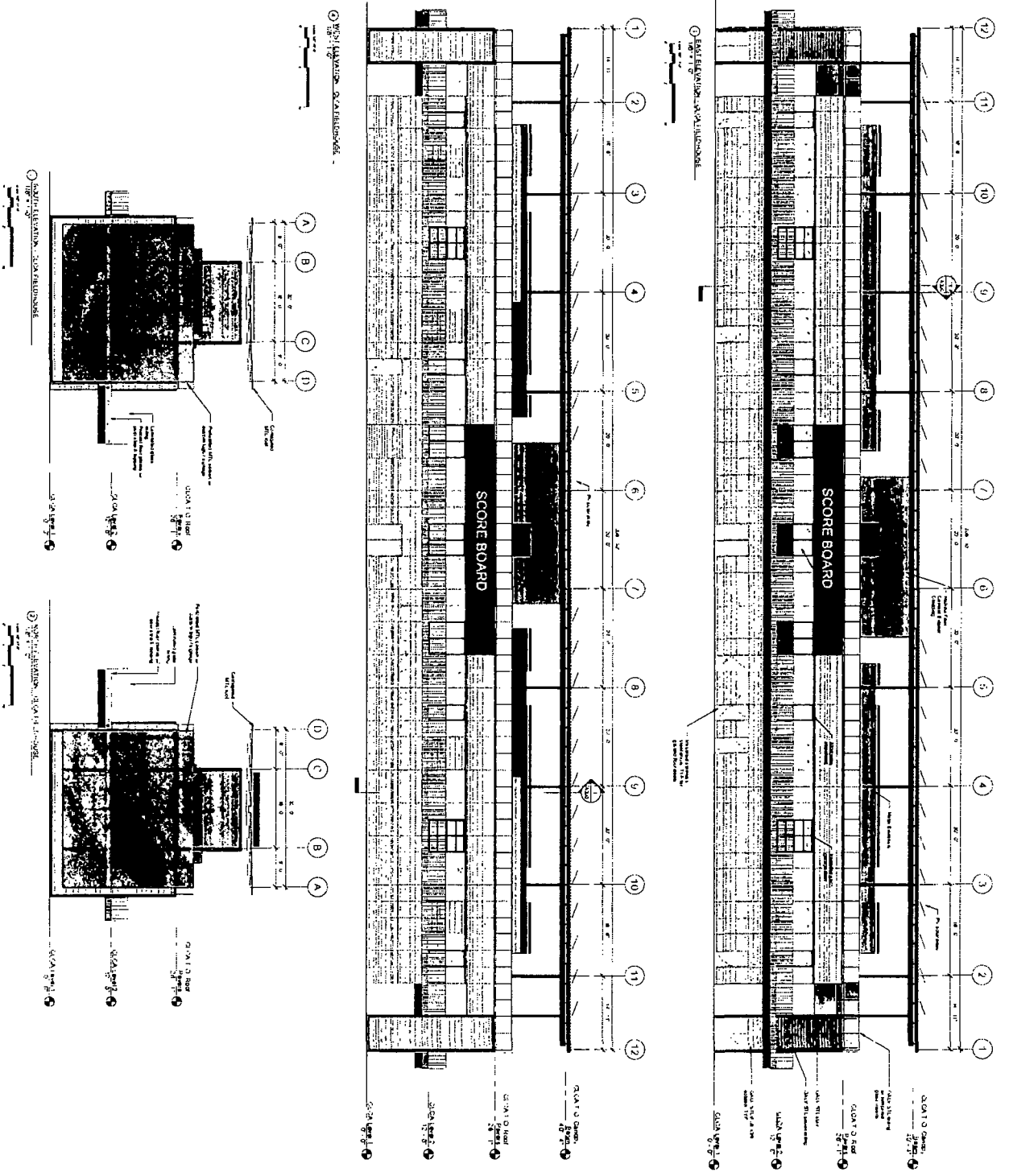

CHICAGO HOPE ACADEMY + CHICAGO LIONS CHARITABLE ASSOCIATION
 2637 W Polk Street
 Chicago, IL 60612

BUILDING SECTION - Q.C.A.
 FIELDHOUSE
A202

NO.	DESCRIPTION	DATE
1	ISSUED FOR PERMITS	11/11/11
2	ISSUED FOR PERMITS	11/11/11
3	ISSUED FOR PERMITS	11/11/11
4	ISSUED FOR PERMITS	11/11/11
5	ISSUED FOR PERMITS	11/11/11
6	ISSUED FOR PERMITS	11/11/11
7	ISSUED FOR PERMITS	11/11/11
8	ISSUED FOR PERMITS	11/11/11
9	ISSUED FOR PERMITS	11/11/11
10	ISSUED FOR PERMITS	11/11/11

CHICAGO HOPE ACADEMY + CHICAGO LIONS CHARITABLE ASSOCIATION
 2637 W Polk Street
 Chicago, IL 60612

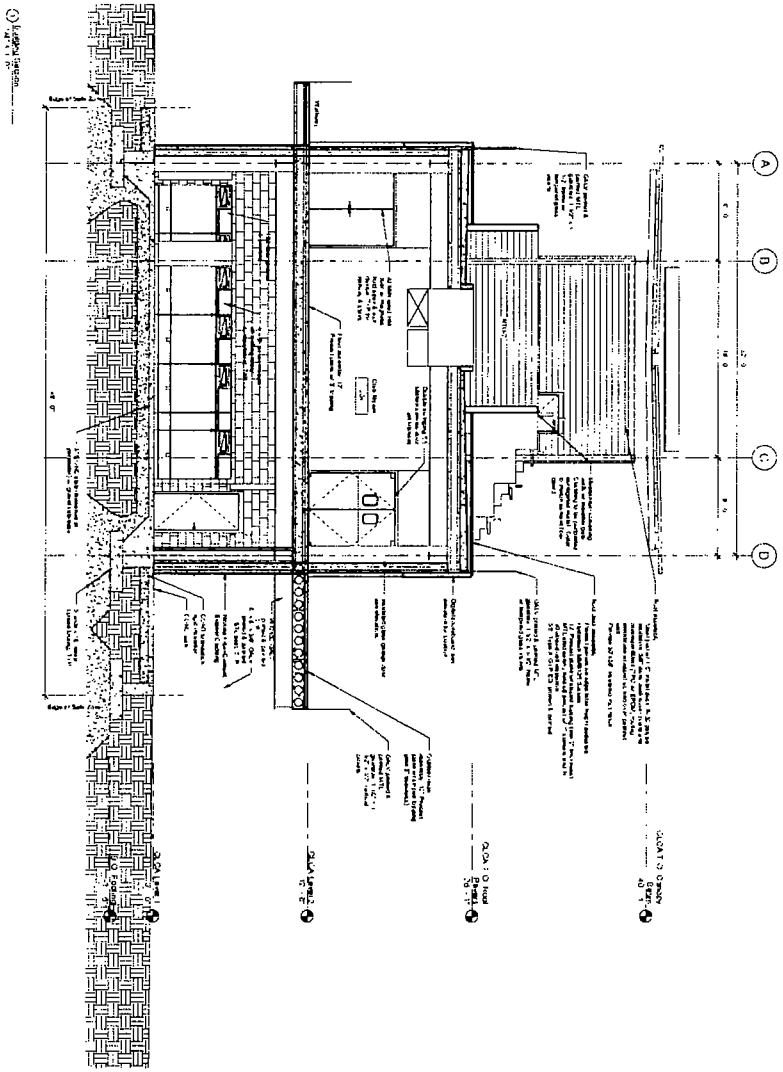

NO.	DESCRIPTION	DATE
1	ISSUED FOR PERMITS	11/11/11
2	ISSUED FOR PERMITS	11/11/11
3	ISSUED FOR PERMITS	11/11/11
4	ISSUED FOR PERMITS	11/11/11
5	ISSUED FOR PERMITS	11/11/11
6	ISSUED FOR PERMITS	11/11/11
7	ISSUED FOR PERMITS	11/11/11
8	ISSUED FOR PERMITS	11/11/11
9	ISSUED FOR PERMITS	11/11/11
10	ISSUED FOR PERMITS	11/11/11

General Landscape Notes

1. ALL PLANTINGS SHALL BE INSTALLED AND MAINTAINED IN ACCORDANCE WITH THE ILLINOIS LANDSCAPE CONTRACTING BOARD'S (ILLCB) STANDARD PRACTICES AND SPECIFICATIONS.
2. ALL PLANTINGS SHALL BE INSTALLED AND MAINTAINED IN ACCORDANCE WITH THE ILLINOIS LANDSCAPE CONTRACTING BOARD'S (ILLCB) STANDARD PRACTICES AND SPECIFICATIONS.
3. ALL PLANTINGS SHALL BE INSTALLED AND MAINTAINED IN ACCORDANCE WITH THE ILLINOIS LANDSCAPE CONTRACTING BOARD'S (ILLCB) STANDARD PRACTICES AND SPECIFICATIONS.
4. ALL PLANTINGS SHALL BE INSTALLED AND MAINTAINED IN ACCORDANCE WITH THE ILLINOIS LANDSCAPE CONTRACTING BOARD'S (ILLCB) STANDARD PRACTICES AND SPECIFICATIONS.
5. ALL PLANTINGS SHALL BE INSTALLED AND MAINTAINED IN ACCORDANCE WITH THE ILLINOIS LANDSCAPE CONTRACTING BOARD'S (ILLCB) STANDARD PRACTICES AND SPECIFICATIONS.
6. ALL PLANTINGS SHALL BE INSTALLED AND MAINTAINED IN ACCORDANCE WITH THE ILLINOIS LANDSCAPE CONTRACTING BOARD'S (ILLCB) STANDARD PRACTICES AND SPECIFICATIONS.
7. ALL PLANTINGS SHALL BE INSTALLED AND MAINTAINED IN ACCORDANCE WITH THE ILLINOIS LANDSCAPE CONTRACTING BOARD'S (ILLCB) STANDARD PRACTICES AND SPECIFICATIONS.
8. ALL PLANTINGS SHALL BE INSTALLED AND MAINTAINED IN ACCORDANCE WITH THE ILLINOIS LANDSCAPE CONTRACTING BOARD'S (ILLCB) STANDARD PRACTICES AND SPECIFICATIONS.
9. ALL PLANTINGS SHALL BE INSTALLED AND MAINTAINED IN ACCORDANCE WITH THE ILLINOIS LANDSCAPE CONTRACTING BOARD'S (ILLCB) STANDARD PRACTICES AND SPECIFICATIONS.

Ground Median Notes

1. THE GROUND MEDIAN SHALL BE INSTALLED IN ACCORDANCE WITH THE ILLINOIS LANDSCAPE CONTRACTING BOARD'S (ILLCB) STANDARD PRACTICES AND SPECIFICATIONS.
2. THE GROUND MEDIAN SHALL BE INSTALLED IN ACCORDANCE WITH THE ILLINOIS LANDSCAPE CONTRACTING BOARD'S (ILLCB) STANDARD PRACTICES AND SPECIFICATIONS.
3. THE GROUND MEDIAN SHALL BE INSTALLED IN ACCORDANCE WITH THE ILLINOIS LANDSCAPE CONTRACTING BOARD'S (ILLCB) STANDARD PRACTICES AND SPECIFICATIONS.
4. THE GROUND MEDIAN SHALL BE INSTALLED IN ACCORDANCE WITH THE ILLINOIS LANDSCAPE CONTRACTING BOARD'S (ILLCB) STANDARD PRACTICES AND SPECIFICATIONS.
5. THE GROUND MEDIAN SHALL BE INSTALLED IN ACCORDANCE WITH THE ILLINOIS LANDSCAPE CONTRACTING BOARD'S (ILLCB) STANDARD PRACTICES AND SPECIFICATIONS.
6. THE GROUND MEDIAN SHALL BE INSTALLED IN ACCORDANCE WITH THE ILLINOIS LANDSCAPE CONTRACTING BOARD'S (ILLCB) STANDARD PRACTICES AND SPECIFICATIONS.
7. THE GROUND MEDIAN SHALL BE INSTALLED IN ACCORDANCE WITH THE ILLINOIS LANDSCAPE CONTRACTING BOARD'S (ILLCB) STANDARD PRACTICES AND SPECIFICATIONS.
8. THE GROUND MEDIAN SHALL BE INSTALLED IN ACCORDANCE WITH THE ILLINOIS LANDSCAPE CONTRACTING BOARD'S (ILLCB) STANDARD PRACTICES AND SPECIFICATIONS.
9. THE GROUND MEDIAN SHALL BE INSTALLED IN ACCORDANCE WITH THE ILLINOIS LANDSCAPE CONTRACTING BOARD'S (ILLCB) STANDARD PRACTICES AND SPECIFICATIONS.
10. THE GROUND MEDIAN SHALL BE INSTALLED IN ACCORDANCE WITH THE ILLINOIS LANDSCAPE CONTRACTING BOARD'S (ILLCB) STANDARD PRACTICES AND SPECIFICATIONS.

Maintenance

1. THE MAINTENANCE SHALL BE INSTALLED IN ACCORDANCE WITH THE ILLINOIS LANDSCAPE CONTRACTING BOARD'S (ILLCB) STANDARD PRACTICES AND SPECIFICATIONS.
2. THE MAINTENANCE SHALL BE INSTALLED IN ACCORDANCE WITH THE ILLINOIS LANDSCAPE CONTRACTING BOARD'S (ILLCB) STANDARD PRACTICES AND SPECIFICATIONS.
3. THE MAINTENANCE SHALL BE INSTALLED IN ACCORDANCE WITH THE ILLINOIS LANDSCAPE CONTRACTING BOARD'S (ILLCB) STANDARD PRACTICES AND SPECIFICATIONS.
4. THE MAINTENANCE SHALL BE INSTALLED IN ACCORDANCE WITH THE ILLINOIS LANDSCAPE CONTRACTING BOARD'S (ILLCB) STANDARD PRACTICES AND SPECIFICATIONS.
5. THE MAINTENANCE SHALL BE INSTALLED IN ACCORDANCE WITH THE ILLINOIS LANDSCAPE CONTRACTING BOARD'S (ILLCB) STANDARD PRACTICES AND SPECIFICATIONS.
6. THE MAINTENANCE SHALL BE INSTALLED IN ACCORDANCE WITH THE ILLINOIS LANDSCAPE CONTRACTING BOARD'S (ILLCB) STANDARD PRACTICES AND SPECIFICATIONS.
7. THE MAINTENANCE SHALL BE INSTALLED IN ACCORDANCE WITH THE ILLINOIS LANDSCAPE CONTRACTING BOARD'S (ILLCB) STANDARD PRACTICES AND SPECIFICATIONS.
8. THE MAINTENANCE SHALL BE INSTALLED IN ACCORDANCE WITH THE ILLINOIS LANDSCAPE CONTRACTING BOARD'S (ILLCB) STANDARD PRACTICES AND SPECIFICATIONS.
9. THE MAINTENANCE SHALL BE INSTALLED IN ACCORDANCE WITH THE ILLINOIS LANDSCAPE CONTRACTING BOARD'S (ILLCB) STANDARD PRACTICES AND SPECIFICATIONS.
10. THE MAINTENANCE SHALL BE INSTALLED IN ACCORDANCE WITH THE ILLINOIS LANDSCAPE CONTRACTING BOARD'S (ILLCB) STANDARD PRACTICES AND SPECIFICATIONS.

Owner Statement of Compliance

STATE OF ILLINOIS
COUNTY OF COOK

DATE: 08/23/18

BY: [Signature]

Landscape Statement of Compliance

DATE: 08/23/18

BY: [Signature]

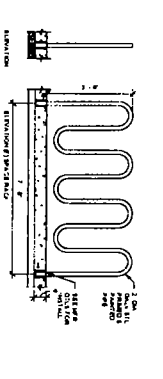
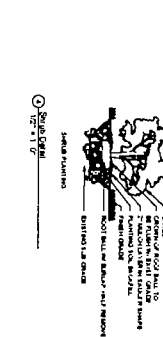
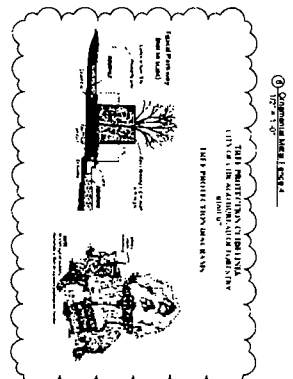
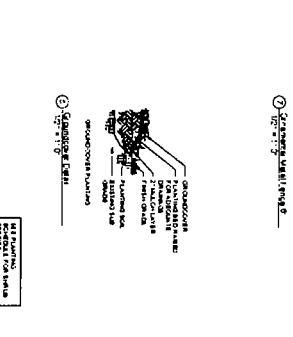
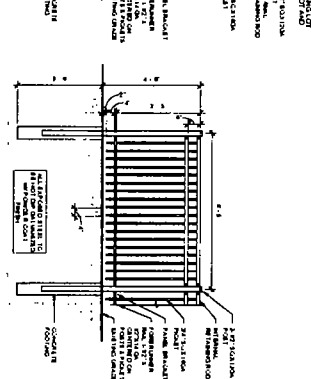
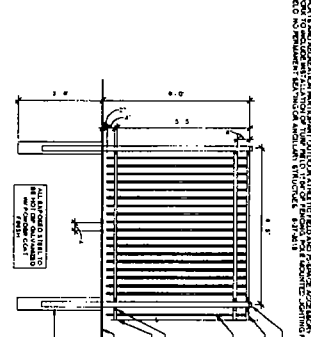
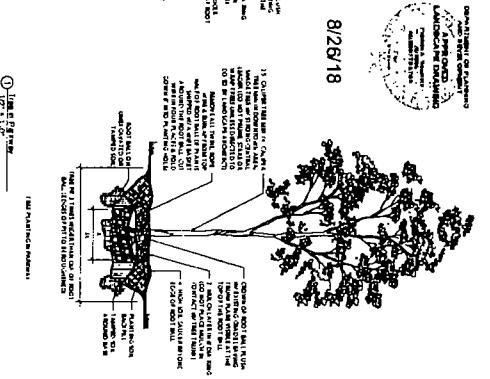
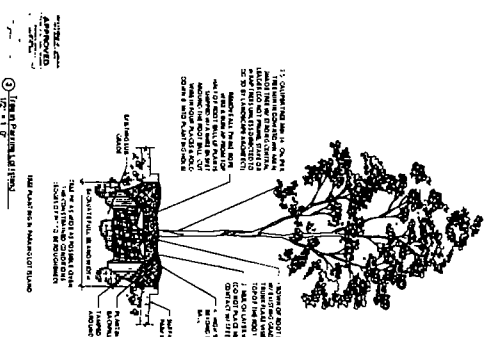
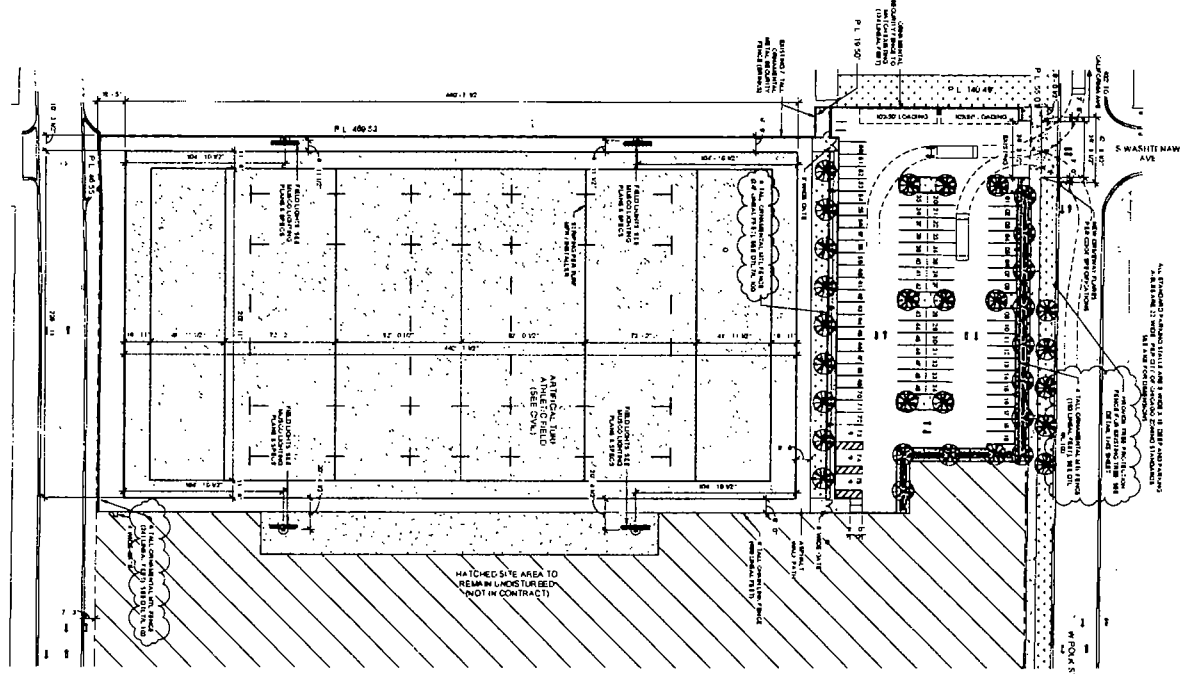

CLCA ATHLETIC FIELD & PARKING LOT

2637 W POLK STREET
CHICAGO, IL 60612

APPROVED
[Signature]

L.100

LANDSCAPE DETAILS
DATE: 08/23/18

Landscape Statement of Compliance

This landscape plan complies with the requirements of the City of Chicago, Illinois, Ordinance 23-111, which requires that all new construction projects include a landscape plan that meets the following criteria:

- 1. The landscape plan must be prepared by a licensed landscape architect or a landscape architect in training who is registered with the State of Illinois.
- 2. The landscape plan must be prepared in accordance with the standards and practices of the landscape architecture profession.
- 3. The landscape plan must be prepared in accordance with the standards and practices of the landscape architecture profession.

DATE: 08/26/18
 DRAWN BY: [Signature]
 CHECKED BY: [Signature]

Owner Statement of Compliance

I, the undersigned, hereby certify that the information provided in this statement is true and correct to the best of my knowledge and belief.

DATE: 08/26/18
 SIGNATURE: [Signature]

Plant Legend

Symbol	Plant Name	Quantity
(Symbol)	Plant Name	Quantity
(Symbol)	Plant Name	Quantity

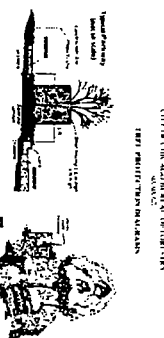

Plant Schedule

Plant Name	Quantity	Notes
Plant Name	Quantity	Notes
Plant Name	Quantity	Notes

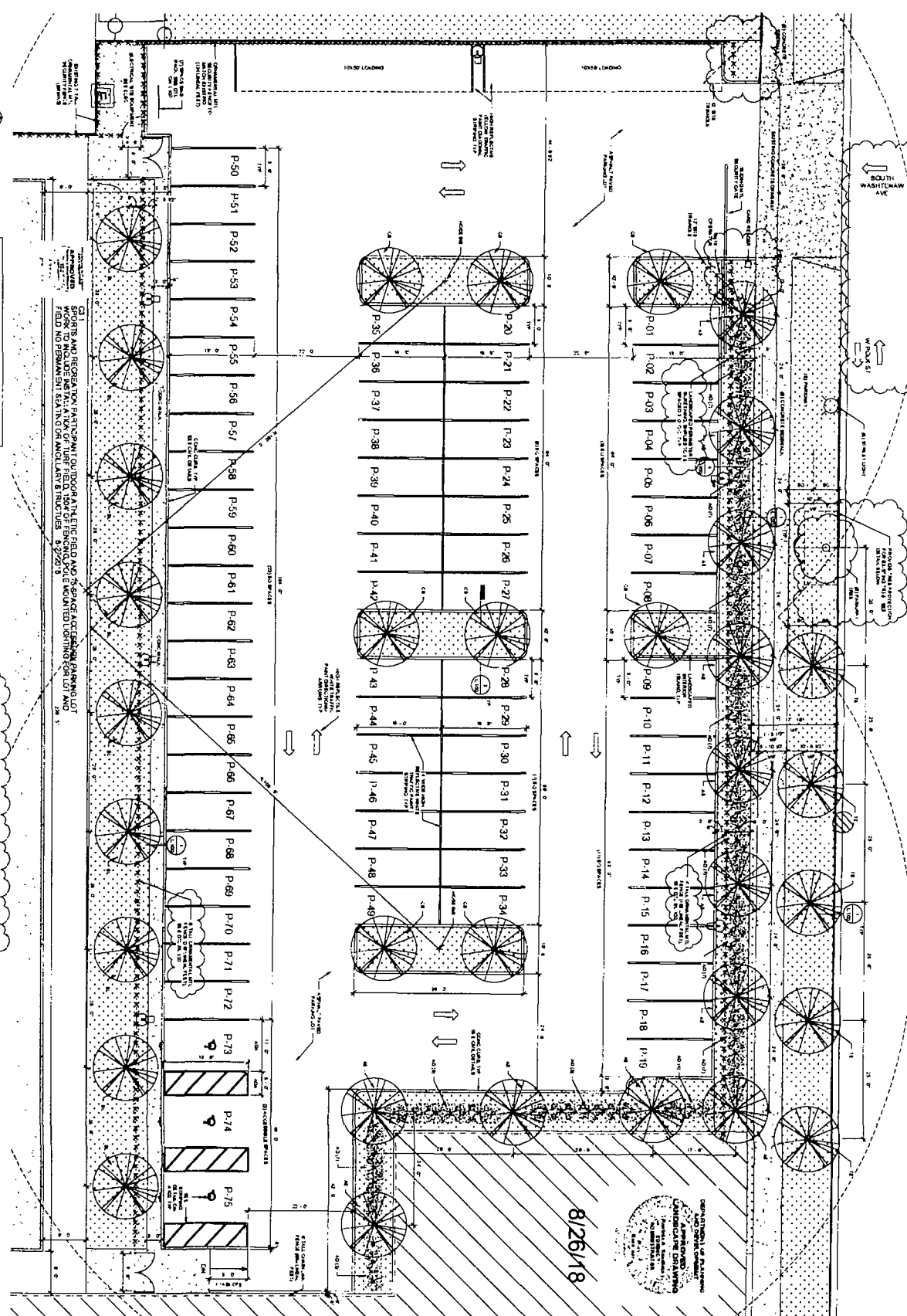

CLCA ATHLETIC FIELD & PARKING LOT

2637 W POLK STREET
 CHICAGO, IL 60612

L.101

APPROVED

Professional seal and signature of the landscape architect.

DATE: 8/26/18

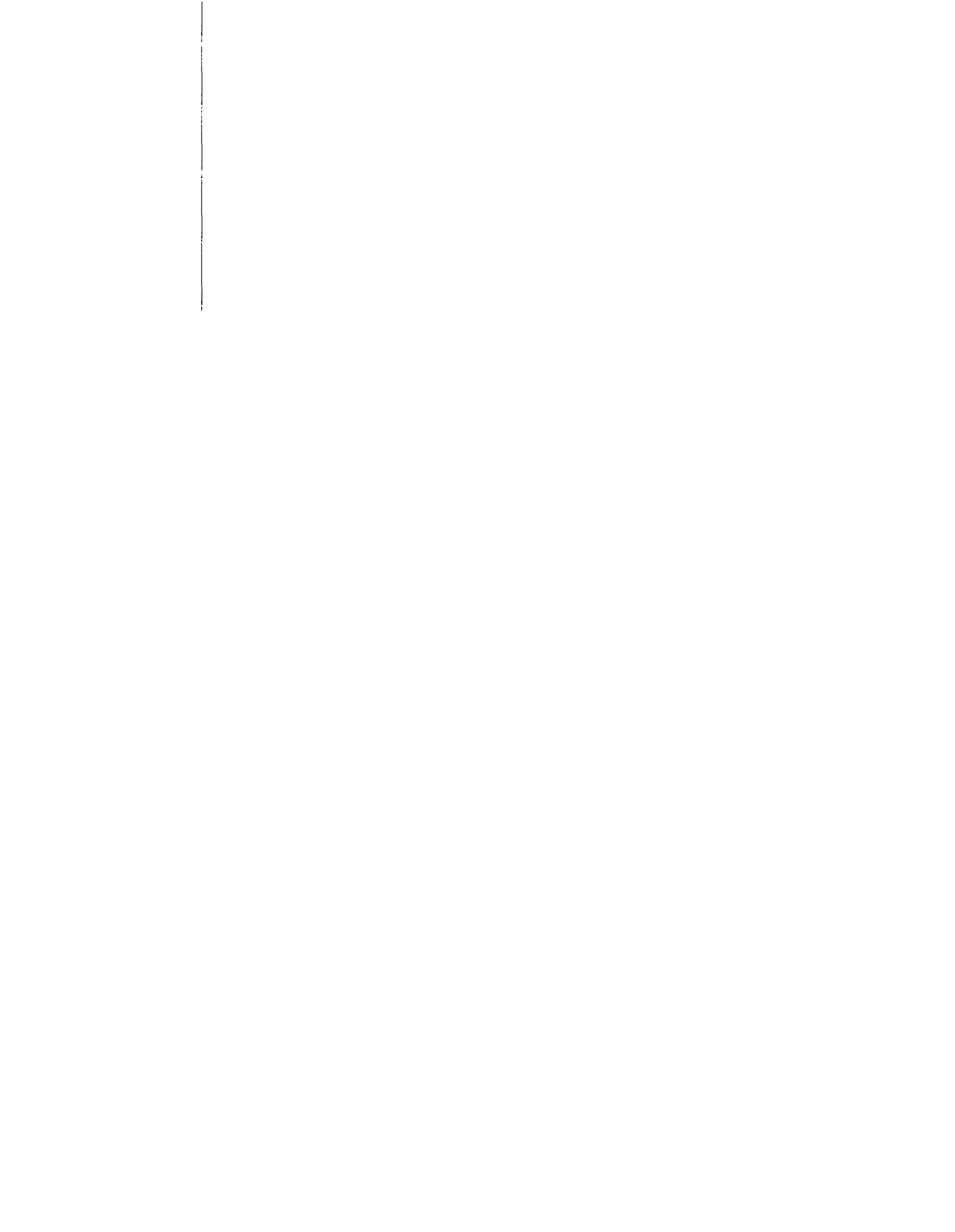

"WRITTEN NOTICE"
FORM OF AFFIDAVIT
(Section 17-13-0107)

September 9, 2019

Honorable Thomas M. Tunney
Chairman, Committee on Zoning
121 North LaSalle Street
Room 304, City Hall
Chicago, Illinois 60602

The undersigned, being first duly sworn on oath deposes and states the following:

The undersigned certifies that he has complied with the requirements of Section 17-13-0107 of the Chicago Zoning Ordinance, by sending revised written notice to such property owners who appear to be the owners of the property within the subject area not solely owned by the applicant, and to the owners of all property within 250 feet in each direction of the lot line of the subject property, exclusive of public roads, streets, alleys and other public ways, or a total distance limited to 400 feet. Said revised "written notice" was sent by First Class U.S. Mail, no more than 30 days before filing the application.

The undersigned certifies that the notice contained the address of the property sought to be rezoned; a statement of the intended use of the property; the name and address of the applicant; the name and address of the owner; and a statement that the applicant intends to file the amended application for a change in zoning on approximately September 9, 2019.

The undersigned certifies that the applicant has made a bona fide effort to determine the addresses of the parties to be notified under Section 17-13-0107 of the Chicago Zoning Ordinance, and that the accompanying list of names and addresses of surrounding property owners within 250 feet of the subject site is a complete list containing the names and addresses of the people required to be served.

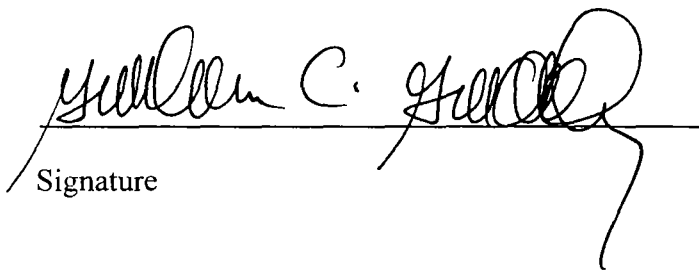
Signature

Subscribed and Sworn to before me this
9th day of September, 20 19.

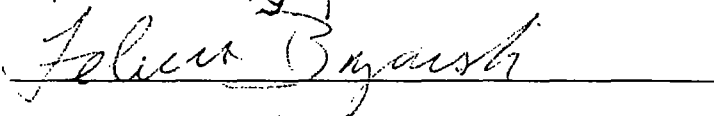
Notary Public



Via USPS First Class Mail

September 9, 2019

Dear Property Owner:

In accordance with the requirements for an Amendment to the Chicago Zoning Ordinance, specifically Section 17-13-0107, please be informed that on or about September 9, 2019, the undersigned will file an application for a change in zoning from M1-1 Limited Manufacturing District and C3-1 Commercial, Manufacturing and Employment District to a C3-1 Commercial, Manufacturing and Employment District then to a Institutional Planned Development on behalf of Chicago Hope Academy and Chicago Lions Charitable Association (“Applicants”) for the property located at 731-799 South Washtenaw Avenue/2605-59 West Harrison St.in Chicago, Illinois (refer to attached map) (“Subject Property”). The Applicants and Ringgold Capital IV, LLC collectively own the Subject Property.

The Applicants plan to develop the Subject Property into an interactive community and school campus which will include a) new 3-story school building (148,836 sq. ft.) with an indoor gymnasium and will operate as a private (reduced tuition) high school; b) existing 2-story building (consisting of 55,794 sq. ft., and operating as Quest Multisport), which includes indoor basketball courts/athletic facilities which will be made available for use by students and community residents and will also continue to operate as a commercial facility; c) pedestrian link connecting the proposed 3-story school building and existing 2-story building d) existing multi-sport, field and track facilities; d) two (2) community athletic fields, totaling 352,052 sq. ft., and seating for approximately 6,120 people; and e) a new 2-story fieldhouse (11,000 sq. ft.). The Applicants’ interactive school campus will include a total of 612 parking spaces of which 287 parking spaces will be provided onsite and the remaining 325 parking spaces will be located within the adjacent property located directly south of West Taylor Street. The height of the proposed 3-story school building and fieldhouse are 54 feet and 42 feet, respectively.

Chicago Hope Academy is located at 2189 West Bowler Street Chicago, IL.

Chicago Lions Charitable Association is located at PO Box 532 Northbrook, IL.

Ringgold Capital IV LLC is located at 1045 First Avenue, Suite 120 King of Prussia, PA.

Please note that the Applicants are not seeking to rezone or purchase your property. The Applicants are required by law to send this notice because you own property within 250 feet of the property to be rezoned.

Any questions regarding this notice may be directed to the undersigned, Applicant’s attorney, at Taft, Stettinius & Hollister, 111 East Wacker Drive, Suite 2800, Chicago, IL 60601, (312) 836-4036.

Very truly yours,

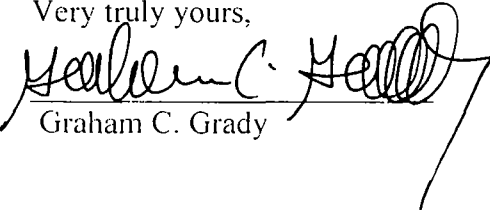
Graham C. Grady

CHICAGO HOPE ACADEMY/CHICAGO LIONS CHARITABLE ASSOCIATION

EXHIBIT A

I. Applicants

Chicago Hope Academy (“CHA”)
2189 West Bowler Street
Chicago, IL 60612
Telephone no.: 312-491-1600
Email: bobmuzikowski@chicagohopeacademy.com
Contact Person: Robert Muzikowski

Chicago Lions Charitable Association (“CLCA”)
PO Box 532
Northbrook, IL 60065
Telephone no.: 847-921-0872
Email: clca@chicagolions.com
Contact Person: Jeff Simon

II. Property Owners

A. Chicago Hope Academy

Owner (100%) of property located at 2608-60 W. Lexington Ave; 2661 W. Lexington Ave.; 919 S. Fairfield Avenue; 2659 W. Flournoy (identified as Parcel B on attached map) (Acquired 9/2012)

Owner (50% Tenants in Common) of the property located at 2611-61 W. Polk Street; 2611-30 West Arthington St.; 2646 West Arthington St.; 2636 West Taylor St. (identified as Parcel C on attached map). (Acquired 4/2015)

B. Chicago Hope Academy/Chicago Lions Charitable Association

Owner (50% Tenants in Common) of the property located at 2611-61 W. Polk Street; 2611-30 West Arthington St.; 2646 West Arthington St.; 2636 West Taylor St. (identified as Parcel C on attached map).

C. Ringgold Capital IV, LLC

Owner of property located at 2641 West Harrison Street
Ringgold Capital IV, LLC
1045 First Avenue, Suite 120
King of Prussia, PA 19406
Contact Person: Robert Fedoris

CHICAGO HOPE ACADEMY/CHICAGO LIONS CHARITABLE ASSOCIATION

EXHIBIT B

In addition to the description provided in #13 of the Zoning Amendment Application form, Applicant's interactive community and school campus will include a total of 612 parking spaces of which 287 parking spaces will be provided onsite and the remaining 325 parking spaces will be located within the adjacent property located directly south of West Taylor Street.

The height of the proposed 3-story school building and fieldhouse are 54 feet and 42 feet, respectively.

September 5, 2019

Chairman, Committee on Zoning
Room 304 – City Hall
Chicago, Illinois 60602

Department of Planning & Development
Room 905 – City Hall
Chicago, IL 60602

To Whom It May Concern:

I, Robert Muzikowski, President of Chicago Hope Academy, understands that Graham C. Grady of Taft, Stettinius and Hollister LLP has filed a sworn affidavit identifying Chicago Hope Academy as a) the Applicant of the property bounded by West Harrison Street on the north; South Washtenaw Avenue on the west; West Taylor Street on the south and the elevated portion of the Union Pacific Railroad on the east (identified as Parcel A on attached map) and b) Owner of the property located at 2608-60 W. Lexington Ave; 2661 W. Lexington Ave.; 919 S. Fairfield Avenue; 2659 W. Flornoy (identified as Parcel B on attached map) and c) Owner (50% Tenants in Common) of the property located at 2611-61 W. Polk Street; 2611-30 West Arthington St.;2646 West Arthington St.;2636 West Taylor St. (identified as Parcel C on attached map).

Chicago Hope Academy is seeking an amendment of the zoning for the property bounded by West Harrison Street on the north; South Washtenaw Avenue on the west; West Taylor Street on the south and the elevated portion of the Union Pacific Railroad on the east (identified as Parcel A on attached map) to be changed from the existing C3-1 Commercial, Manufacturing and Employment District and M1-1 Limited Manufacturing/Business Park District to a C3-1 Commercial, Manufacturing and Employment District then to an Institutional Planned Development.

I authorize Graham C. Grady and the law firm of Taft, Stettinius & Hollister LLP to file the Planned Development application.

I, Robert Muzikowski, President of Chicago Hope Academy, being first duly sworn on oath, depose and say that Chicago Hope Academy holds ownership interest in 2608-60 W. Lexington Ave; 2661 W. Lexington Ave.; 919 S. Fairfield Avenue; 2659 W. Flornoy (identified as Parcel B on attached map) and 2611-61 W. Polk Street; 2611-30 West Arthington St.;2646 West Arthington St.;2636 West Taylor St. (identified as Parcel C on attached map) on behalf of itself and no other person, association, or member.

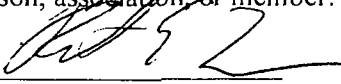

Robert Muzikowski
President
Chicago Hope Academy

SUBSCRIBED AND SWORN to before me this
9 day of 9 2019



NOTARY PUBLIC

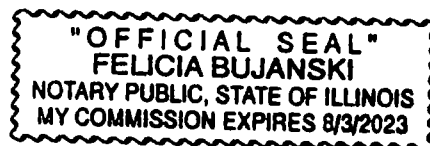

September 5, 2019

Chairman, Committee on Zoning
Room 304 – City Hall
Chicago, Illinois 60602

Department of Planning and Development
Room 905 – City Hall
Chicago, Illinois 60602

To Whom It May Concern:

I, Jeff Simon, President of Chicago Lions Charitable Association, understands that Graham C. Grady of Taft, Stettinius and Hollister LLP has filed a sworn affidavit identifying Chicago Lions Charitable Association as a) the Applicant of the property bounded by West Harrison Street on the north; South Washtenaw Avenue on the west; West Taylor Street on the south and the elevated portion of the Union Pacific Railroad on the east (identified as Parcel A on attached map) and b) Owner (50% Tenants in Common) of the property located at 2611-61 W. Polk Street; 2611-30 West Arthington St.; 2646 West Arthington St.; 2636 West Taylor St. (identified as Parcel C on attached map).

Chicago Lions Charitable Association is seeking an amendment of the zoning for the property bounded by West Harrison Street on the north; South Washtenaw Avenue on the west; West Taylor Street on the south and the elevated portion of the Union Pacific Railroad on the east (identified as Parcel A on attached map) to be changed from the existing C3-1 Commercial, Manufacturing and Employment District & M1-1 Limited Manufacturing/Business Park District to a C3-1 Commercial, Manufacturing and Employment District then to an Institutional Planned Development.

I authorize Graham C. Grady and the law firm of Taft, Stettinius & Hollister LLP to file the Planned Development application.

I, Jeff Simon, President of Chicago Lions Charitable Association, being first duly sworn on oath, depose and say that Chicago Lions Charitable Association holds ownership interest in 2611-61 W. Polk Street; 2611-30 West Arthington St.; 2646 West Arthington St.; 2636 West Taylor St. (identified as Parcel C on attached map).

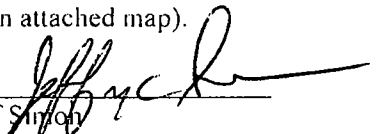

Jeff Simon
President
Chicago Lions Charitable Association

SUBSCRIBED AND SWORN to before me this

9 day of 9 2019



NOTARY PUBLIC



AFFIDAVIT

Re: Quest Multisport
2641 W. Harrison St., Chicago, Illinois

To Whom It May Concern at the City of Chicago:

This affidavit is to inform that Ringgold Capital IV, LLC, owner of the Quest Multisport and property located at 2641 W. Harrison St., Chicago, Illinois, authorizes attorneys of the law firm of Taft, Stettinius & Hollister, LLP, to file an application for a zoning map amendment to change the zoning district of the subject property for inclusion of the subject property in a Planned Development.

Robert Fedoris 09/09/2019
Robert Fedoris Date
Manager
Ringgold Capital IV, LLC
1045 First Avenue, Suite 120
King of Prussia, PA 19406

Notary:
State of Illinois
County of Cook
Signed (or attested) before me on September 9th, 2019 (date)
by Robert Fedoris (name(s) of individual(s)).
Signature of notarial officer Brooke H Schlichtman
Stamp
Title of office Notary Public
My commission expires: July 12, 2022

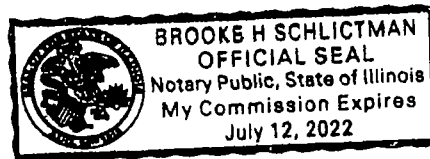

#20196
INTRO DATE
SEPT 18, 2019

CITY OF CHICAGO

APPLICATION FOR AN AMENDMENT TO
THE CHICAGO ZONING ORDINANCE

1. ADDRESS of the property Applicant is seeking to rezone:
731-799 South Washtenaw Ave./2605-59 West Harrison St (see attached Parcel A)

2. Ward Number that property is located in: 28

3. APPLICANT Chicago Hope Academy/Chicago Lions Charitable Organization

ADDRESS 2189 West Bowler Street CITY Chicago

STATE IL ZIP CODE 60612 PHONE 312-491-1600

EMAIL bmuzikowski@chicagohopeacademy.org CONTACT PERSON Robert Muzikowski
(Please note Exhibit A for complete list of Applicants/Property Owners)

4. Is the applicant the owner of the property? YES X NO
If the applicant is not the owner of the property, please provide the following information regarding the owner and attach written authorization from the owner allowing the application to proceed.

OWNER Chicago Hope Academy

ADDRESS 2189 West Bowler Street CITY Chicago

STATE IL ZIP CODE 60612 PHONE 312-491-1600

EMAIL bobmuzikowski@chicagohopeacademy.com CONTACT PERSON Robert Muzikowski

5. If the Applicant/Owner of the property has obtained a lawyer as their representative for the rezoning, please provide the following information:

ATTORNEY Graham C Grady c/o Taft, Stettinius & Hollister LLP

ADDRESS 111 East Wacker Drive Suite 2800

CITY Chicago STATE IL ZIP CODE 60601

PHONE 312-836-4036 FAX EMAIL ggrady@taftlaw.com

6. If the applicant is a legal entity (Corporation, LLC, Partnership, etc.) please provide the names of all owners as disclosed on the Economic Disclosure Statements.

Applicants include Chicago Hope Academy and Chicago Lions Charitable Association and are 501(c)(3)

not-for-profit corporations

7. On what date did the owner acquire legal title to the subject property? Refer to Exhibit A

8. Has the present owner previously rezoned this property? If yes, when?

No

9. Present Zoning District M1-1 Limited Manufacturing District & C3-1 Commercial, Manufacturing and Employment District Proposed Zoning District C3-1 Commercial, Manufacturing and Employment District then to Institutional Planned Development

10. Lot size in square feet (or dimensions) 958,320 sq. ft. (22 acres)

11. Current Use of the property The subject property is partially improved with an existing 2-story gymnasium, operated by Quest Multisport, outdoor running track, athletic field (located on the westren portion of the subject property) and 112 existing parking spaces. The remainder of the subject property is vacant and unimproved

12. Reason for rezoning the property The Applicants plan to develop the property with an interactive community and school campus, which will include a new 3-story school building with indoor gymnasium, two (2) community athletic fields, a 2-story fieldhouse, existing multi-sport, field and track facilities and the existing 2-story building, which will continue to operate as Quest Multisport. As the property exceeds 2 acres in size, a mandatory Planned Development is required in order to permit the proposed school campus

13. Describe the proposed use of the property after the rezoning. Indicate the number of dwelling units; number of parking spaces; approximate square footage of any commercial space; and height of the proposed building. (BE SPECIFIC)

The subject property will be developed with an interactive community and school campus which will include a) new 3-story school building (148,836 sq ft) with an indoor gymnasium and operate as a private (reduced tuition) high school, b) existing 2-story building consisting of 55,794 sq. ft. which will continue to operate as Quest Multisport, which includes indoor basketball courts/ athletic facilities and will be made available for use by students and community residents and continue as a commercial facility. c) a pedestrian link connecting the proposed 3-story school building and existing 2-story Quest Multisport building, d) existing multi-sport, track and field facilities, d) two (2) community athletic fields containing a total of 352,052 sq ft , with seating for 6,120 people and e) a new 2-story fieldhouse (11,000 sq feet) (Refer to Exhibit B for continued description of proposed use of property)

14. The Affordable Requirements Ordinance (ARO) requires on-site affordable housing units and/or a financial contribution for residential housing projects with ten or more units that receive a zoning change which, among other triggers, increases the allowable floor area, or, for existing Planned Developments, increases the number of units (see attached fact sheet or visit www.cityofchicago.org/ARO for more information). Is this project subject to the ARO?

YES _____ NO X _____

COUNTY OF COOK
STATE OF ILLINOIS

I, Robert Muzikowski, as President and on behalf of Chicago Hope Academy being first duly sworn on oath, states that all of the above statements and the statements contained in the documents submitted herewith are true and correct.

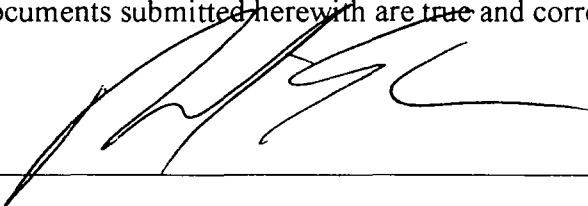

Signature of Applicant

Subscribed and Sworn to before me this
9 day of September, 2019.

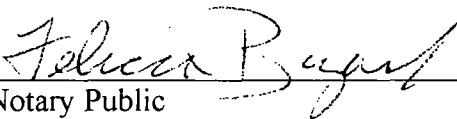

Notary Public



For Office Use Only

Date of Introduction: _____

File Number: _____

Ward: _____

**CITY OF CHICAGO
ECONOMIC DISCLOSURE STATEMENT
AND AFFIDAVIT**

SECTION I -- GENERAL INFORMATION

A. Legal name of the Disclosing Party submitting this EDS. Include d/b/a/ if applicable:

Chicago Hope Academy

Check ONE of the following three boxes:

Indicate whether the Disclosing Party submitting this EDS is:

1. the Applicant

OR

2. a legal entity currently holding, or anticipated to hold within six months after City action on the contract, transaction or other undertaking to which this EDS pertains (referred to below as the "Matter"), a direct or indirect interest in excess of 7.5% in the Applicant. State the Applicant's legal name: _____

OR

3. a legal entity with a direct or indirect right of control of the Applicant (see Section II(B)(1))
State the legal name of the entity in which the Disclosing Party holds a right of control:

B. Business address of the Disclosing Party: 2189 W Bowler Street

Chicago, IL 60612

C. Telephone: 312-491-1600 Fax: 312-491-1616 Email: bmuzikowski@chicagohopeacademy.org

D. Name of contact person: Robert Muzikowski

E. Federal Employer Identification No. (if you have one): _____

F. Brief description of the Matter to which this EDS pertains. (Include project number and location of property, if applicable):

~~Planned Development application for the property bounded by West Harrison Street on the north, South Washtenaw Avenue on the east, West Taylor Street on the south and the elevated portion of the Union Pacific Railroad on the east (identified as Parcel A on attached map)~~

G. Which City agency or department is requesting this EDS? Department of Planning & Development

If the Matter is a contract being handled by the City's Department of Procurement Services, please complete the following:

Specification # _____ and Contract # _____

SECTION II -- DISCLOSURE OF OWNERSHIP INTERESTS

A. NATURE OF THE DISCLOSING PARTY

1. Indicate the nature of the Disclosing Party:

- | | |
|---|---|
| <input type="checkbox"/> Person | <input type="checkbox"/> Limited liability company |
| <input type="checkbox"/> Publicly registered business corporation | <input type="checkbox"/> Limited liability partnership |
| <input type="checkbox"/> Privately held business corporation | <input type="checkbox"/> Joint venture |
| <input type="checkbox"/> Sole proprietorship | <input checked="" type="checkbox"/> Not-for-profit corporation |
| <input type="checkbox"/> General partnership | (Is the not-for-profit corporation also a 501(c)(3))? |
| <input type="checkbox"/> Limited partnership | <input checked="" type="checkbox"/> Yes <input type="checkbox"/> No |
| <input type="checkbox"/> Trust | <input type="checkbox"/> Other (please specify) |
-

2. For legal entities, the state (or foreign country) of incorporation or organization, if applicable:

Illinois

3. For legal entities not organized in the State of Illinois: Has the organization registered to do business in the State of Illinois as a foreign entity?

- Yes No Organized in Illinois

B. IF THE DISCLOSING PARTY IS A LEGAL ENTITY:

1. List below the full names and titles, if applicable, of: (i) all executive officers and all directors of the entity; (ii) **for not-for-profit corporations**, all members, if any, which are legal entities (if there are no such members, write "no members which are legal entities"); (iii) **for trusts, estates or other similar entities**, the trustee, executor, administrator, or similarly situated party; (iv) **for general or limited partnerships, limited liability companies, limited liability partnerships or joint ventures**, each general partner, managing member, manager or any other person or legal entity that directly or indirectly controls the day-to-day management of the Applicant.

NOTE: Each legal entity listed below must submit an EDS on its own behalf.

Name	Title
------	-------

See attached list of officers and directors (none are legal entities)

2. Please provide the following information concerning each person or legal entity having a direct or indirect, current or prospective (i.e. within 6 months after City action) beneficial interest (including ownership) in excess of 7.5% of the Applicant. Examples of such an interest include shares in a corporation, partnership interest in a partnership or joint venture, interest of a member or manager in a

Chicago Hope Academy

BOARD MEMBERS

NAME	POSITION	COMPANY	YEARS ON BOARD
Robert E. Muzikowski	Founder and President	Chicago Hope Academy	13 years
Jim Sharman	Board Secretary	COO of Coyote Logistics	9 years
Curtis Hart	Member	Founding Partner, Manna Capital	6 years
Alex Moore	Member	Managing Director at Loop Capital Markets, LLC	5 years
Simon Blanks	Member	Sales Director – The Enterprise Cloud Company	6 years
Gregg E. Vann	Member	Tax and Investment Consultant at James T. Borello & Co	6 years
Rev. BJ Weber	Member	Head Pastor at New York Fellowship Church	13 years
Peter Giersch	Member	The Giersch Group	2 years
David Lewis, Atty.	Member	Darrell & Bailee	1 year
Joshua Cauhorn, Atty.*	Member	Burke, Warren, MacKay & Serritella	1 year

*taught at Hope 3 years prior to Law school

limited liability company, or interest of a beneficiary of a trust, estate or other similar entity. If none, state "None."

NOTE: Each legal entity listed below may be required to submit an EDS on its own behalf.

Name	Business Address	Percentage Interest in the Applicant
None		

SECTION III -- INCOME OR COMPENSATION TO, OR OWNERSHIP BY, CITY ELECTED OFFICIALS

Has the Disclosing Party provided any income or compensation to any City elected official during the 12-month period preceding the date of this EDS? Yes No

Does the Disclosing Party reasonably expect to provide any income or compensation to any City elected official during the 12-month period following the date of this EDS? Yes No

If "yes" to either of the above, please identify below the name(s) of such City elected official(s) and describe such income or compensation:

Does any City elected official or, to the best of the Disclosing Party's knowledge after reasonable inquiry, any City elected official's spouse or domestic partner, have a financial interest (as defined in Chapter 2-156 of the Municipal Code of Chicago ("MCC")) in the Disclosing Party?

Yes No

If "yes," please identify below the name(s) of such City elected official(s) and/or spouse(s)/domestic partner(s) and describe the financial interest(s).

SECTION IV -- DISCLOSURE OF SUBCONTRACTORS AND OTHER RETAINED PARTIES

The Disclosing Party must disclose the name and business address of each subcontractor, attorney, lobbyist (as defined in MCC Chapter 2-156), accountant, consultant and any other person or entity whom the Disclosing Party has retained or expects to retain in connection with the Matter, as well as the nature of the relationship, and the total amount of the fees paid or estimated to be paid. The Disclosing Party is not required to disclose employees who are paid solely through the Disclosing Party's regular payroll. If the Disclosing Party is uncertain whether a disclosure is required under this Section, the Disclosing Party must either ask the City whether disclosure is required or make the disclosure.

Name (indicate whether retained or anticipated to be retained)	Business Address	Relationship to Disclosing Party (subcontractor, attorney, lobbyist, etc.)	Fees (<u>indicate whether paid or estimated.</u>) NOTE: "hourly rate" or "t.b.d." is not an acceptable response.
--	------------------	--	---

Taft, Stettinius & Hollister (retained)	111 East Wacker Drive Chicago, IL 60601	Attorney	\$35,000 (estimated)
Team A Architecture (retained)	405 West Superior St Chicago, IL 60654	Architect	\$25,000 (estimated)

(Add sheets if necessary)

Check here if the Disclosing Party has not retained, nor expects to retain, any such persons or entities.

SECTION V -- CERTIFICATIONS

A. COURT-ORDERED CHILD SUPPORT COMPLIANCE

Under MCC Section 2-92-415, substantial owners of business entities that contract with the City must remain in compliance with their child support obligations throughout the contract's term.

Has any person who directly or indirectly owns 10% or more of the Disclosing Party been declared in arrearage on any child support obligations by any Illinois court of competent jurisdiction?

Yes No No person directly or indirectly owns 10% or more of the Disclosing Party.

If "Yes," has the person entered into a court-approved agreement for payment of all support owed and is the person in compliance with that agreement?

Yes No

B. FURTHER CERTIFICATIONS

1. [This paragraph 1 applies only if the Matter is a contract being handled by the City's Department of Procurement Services.] In the 5-year period preceding the date of this EDS, neither the Disclosing Party nor any Affiliated Entity [see definition in (5) below] has engaged, in connection with the performance of any public contract, the services of an integrity monitor, independent private sector inspector general, or integrity compliance consultant (i.e., an individual or entity with legal, auditing, investigative, or other similar skills, designated by a public agency to help the agency monitor the activity of specified agency vendors as well as help the vendors reform their business practices so they can be considered for agency contracts in the future, or continue with a contract in progress).

2. The Disclosing Party and its Affiliated Entities are not delinquent in the payment of any fine, fee, tax or other source of indebtedness owed to the City of Chicago, including, but not limited to, water and sewer charges, license fees, parking tickets, property taxes and sales taxes, nor is the Disclosing Party delinquent in the payment of any tax administered by the Illinois Department of Revenue.

3. The Disclosing Party and, if the Disclosing Party is a legal entity, all of those persons or entities identified in Section II(B)(1) of this EDS:

- a. are not presently debarred, suspended, proposed for debarment, declared ineligible or voluntarily excluded from any transactions by any federal, state or local unit of government;
- b. have not, during the 5 years before the date of this EDS, been convicted of a criminal offense, adjudged guilty, or had a civil judgment rendered against them in connection with: obtaining, attempting to obtain, or performing a public (federal, state or local) transaction or contract under a public transaction; a violation of federal or state antitrust statutes; fraud; embezzlement; theft; forgery; bribery; falsification or destruction of records; making false statements; or receiving stolen property;
- c. are not presently indicted for, or criminally or civilly charged by, a governmental entity (federal, state or local) with committing any of the offenses set forth in subparagraph (b) above;
- d. have not, during the 5 years before the date of this EDS, had one or more public transactions (federal, state or local) terminated for cause or default; and
- e. have not, during the 5 years before the date of this EDS, been convicted, adjudged guilty, or found liable in a civil proceeding, or in any criminal or civil action, including actions concerning environmental violations, instituted by the City or by the federal government, any state, or any other unit of local government.

4. The Disclosing Party understands and shall comply with the applicable requirements of MCC Chapters 2-56 (Inspector General) and 2-156 (Governmental Ethics).

5. Certifications (5), (6) and (7) concern:

- the Disclosing Party;
- any "Contractor" (meaning any contractor or subcontractor used by the Disclosing Party in connection with the Matter, including but not limited to all persons or legal entities disclosed under Section IV, "Disclosure of Subcontractors and Other Retained Parties");
- any "Affiliated Entity" (meaning a person or entity that, directly or indirectly: controls the Disclosing Party, is controlled by the Disclosing Party, or is, with the Disclosing Party, under common control of another person or entity). Indicia of control include, without limitation: interlocking management or ownership; identity of interests among family members, shared facilities and equipment; common use of employees; or organization of a business entity following the ineligibility of a business entity to do business with federal or state or local government, including the City, using substantially the same management, ownership, or principals as the ineligible entity. With respect to Contractors, the term Affiliated Entity means a person or entity that directly or indirectly controls the Contractor, is controlled by it, or, with the Contractor, is under common control of another person or entity;
- any responsible official of the Disclosing Party, any Contractor or any Affiliated Entity or any other official, agent or employee of the Disclosing Party, any Contractor or any Affiliated Entity, acting pursuant to the direction or authorization of a responsible official of the Disclosing Party, any Contractor or any Affiliated Entity (collectively "Agents").

Neither the Disclosing Party, nor any Contractor, nor any Affiliated Entity of either the Disclosing Party or any Contractor, nor any Agents have, during the 5 years before the date of this EDS, or, with respect to a Contractor, an Affiliated Entity, or an Affiliated Entity of a Contractor during the 5 years before the date of such Contractor's or Affiliated Entity's contract or engagement in connection with the Matter:

- a. bribed or attempted to bribe, or been convicted or adjudged guilty of bribery or attempting to bribe, a public officer or employee of the City, the State of Illinois, or any agency of the federal government or of any state or local government in the United States of America, in that officer's or employee's official capacity;
- b. agreed or colluded with other bidders or prospective bidders, or been a party to any such agreement, or been convicted or adjudged guilty of agreement or collusion among bidders or prospective bidders, in restraint of freedom of competition by agreement to bid a fixed price or otherwise; or
- c. made an admission of such conduct described in subparagraph (a) or (b) above that is a matter of record, but have not been prosecuted for such conduct; or
- d. violated the provisions referenced in MCC Subsection 2-92-320(a)(4)(Contracts Requiring a Base Wage); (a)(5)(Debarment Regulations); or (a)(6)(Minimum Wage Ordinance).

6. Neither the Disclosing Party, nor any Affiliated Entity or Contractor, or any of their employees, officials, agents or partners, is barred from contracting with any unit of state or local government as a result of engaging in or being convicted of (1) bid-rigging in violation of 720 ILCS 5/33E-3; (2) bid-rotating in violation of 720 ILCS 5/33E-4; or (3) any similar offense of any state or of the United States of America that contains the same elements as the offense of bid-rigging or bid-rotating.

7. Neither the Disclosing Party nor any Affiliated Entity is listed on a Sanctions List maintained by the United States Department of Commerce, State, or Treasury, or any successor federal agency.

8. [FOR APPLICANT ONLY] (i) Neither the Applicant nor any "controlling person" [see MCC Chapter 1-23, Article I for applicability and defined terms] of the Applicant is currently indicted or charged with, or has admitted guilt of, or has ever been convicted of, or placed under supervision for, any criminal offense involving actual, attempted, or conspiracy to commit bribery, theft, fraud, forgery, perjury, dishonesty or deceit against an officer or employee of the City or any "sister agency"; and (ii) the Applicant understands and acknowledges that compliance with Article I is a continuing requirement for doing business with the City. NOTE: If MCC Chapter 1-23, Article I applies to the Applicant, that Article's permanent compliance timeframe supersedes 5-year compliance timeframes in this Section V.

9. [FOR APPLICANT ONLY] The Applicant and its Affiliated Entities will not use, nor permit their subcontractors to use, any facility listed as having an active exclusion by the U.S. EPA on the federal System for Award Management ("SAM").

10. [FOR APPLICANT ONLY] The Applicant will obtain from any contractors/subcontractors hired or to be hired in connection with the Matter certifications equal in form and substance to those in Certifications (2) and (9) above and will not, without the prior written consent of the City, use any such

contractor/subcontractor that does not provide such certifications or that the Applicant has reason to believe has not provided or cannot provide truthful certifications.

11. If the Disclosing Party is unable to certify to any of the above statements in this Part B (Further Certifications), the Disclosing Party must explain below:

NA

If the letters "NA," the word "None," or no response appears on the lines above, it will be conclusively presumed that the Disclosing Party certified to the above statements.

12. To the best of the Disclosing Party's knowledge after reasonable inquiry, the following is a complete list of all current employees of the Disclosing Party who were, at any time during the 12-month period preceding the date of this EDS, an employee, or elected or appointed official, of the City of Chicago (if none, indicate with "N/A" or "none").

NA

13. To the best of the Disclosing Party's knowledge after reasonable inquiry, the following is a complete list of all gifts that the Disclosing Party has given or caused to be given, at any time during the 12-month period preceding the execution date of this EDS, to an employee, or elected or appointed official, of the City of Chicago. For purposes of this statement, a "gift" does not include: (i) anything made generally available to City employees or to the general public, or (ii) food or drink provided in the course of official City business and having a retail value of less than \$25 per recipient, or (iii) a political contribution otherwise duly reported as required by law (if none, indicate with "N/A" or "none"). As to any gift listed below, please also list the name of the City recipient.

NA

C. CERTIFICATION OF STATUS AS FINANCIAL INSTITUTION

1. The Disclosing Party certifies that the Disclosing Party (check one)

is is not

a "financial institution" as defined in MCC Section 2-32-455(b).

2. If the Disclosing Party IS a financial institution, then the Disclosing Party pledges:

"We are not and will not become a predatory lender as defined in MCC Chapter 2-32. We further pledge that none of our affiliates is, and none of them will become, a predatory lender as defined in MCC Chapter 2-32. We understand that becoming a predatory lender or becoming an affiliate of a predatory lender may result in the loss of the privilege of doing business with the City."

If the Disclosing Party is unable to make this pledge because it or any of its affiliates (as defined in MCC Section 2-32-455(b)) is a predatory lender within the meaning of MCC Chapter 2-32, explain here (attach additional pages if necessary):

If the letters "NA," the word "None," or no response appears on the lines above, it will be conclusively presumed that the Disclosing Party certified to the above statements.

D. CERTIFICATION REGARDING FINANCIAL INTEREST IN CITY BUSINESS

Any words or terms defined in MCC Chapter 2-156 have the same meanings if used in this Part D.

1. In accordance with MCC Section 2-156-110: To the best of the Disclosing Party's knowledge after reasonable inquiry, does any official or employee of the City have a financial interest in his or her own name or in the name of any other person or entity in the Matter?

Yes No

NOTE: If you checked "Yes" to Item D(1), proceed to Items D(2) and D(3). If you checked "No" to Item D(1), skip Items D(2) and D(3) and proceed to Part E.

2. Unless sold pursuant to a process of competitive bidding, or otherwise permitted, no City elected official or employee shall have a financial interest in his or her own name or in the name of any other person or entity in the purchase of any property that (i) belongs to the City, or (ii) is sold for taxes or assessments, or (iii) is sold by virtue of legal process at the suit of the City (collectively, "City Property Sale"). Compensation for property taken pursuant to the City's eminent domain power does not constitute a financial interest within the meaning of this Part D.

Does the Matter involve a City Property Sale?

Yes No

3. If you checked "Yes" to Item D(1), provide the names and business addresses of the City officials or employees having such financial interest and identify the nature of the financial interest:

Name	Business Address	Nature of Financial Interest
------	------------------	------------------------------

4. The Disclosing Party further certifies that no prohibited financial interest in the Matter will be acquired by any City official or employee.

E. CERTIFICATION REGARDING SLAVERY ERA BUSINESS

Please check either (1) or (2) below. If the Disclosing Party checks (2), the Disclosing Party must disclose below or in an attachment to this EDS all information required by (2). Failure to comply with these disclosure requirements may make any contract entered into with the City in connection with the Matter voidable by the City.

 x 1. The Disclosing Party verifies that the Disclosing Party has searched any and all records of the Disclosing Party and any and all predecessor entities regarding records of investments or profits from slavery or slaveholder insurance policies during the slavery era (including insurance policies issued to slaveholders that provided coverage for damage to or injury or death of their slaves), and the Disclosing Party has found no such records.

 2. The Disclosing Party verifies that, as a result of conducting the search in step (1) above, the Disclosing Party has found records of investments or profits from slavery or slaveholder insurance policies. The Disclosing Party verifies that the following constitutes full disclosure of all such records, including the names of any and all slaves or slaveholders described in those records:

SECTION VI -- CERTIFICATIONS FOR FEDERALLY FUNDED MATTERS

NOTE: If the Matter is federally funded, complete this Section VI. **If the Matter is not federally funded**, proceed to Section VII. For purposes of this Section VI, tax credits allocated by the City and proceeds of debt obligations of the City are not federal funding.

A. CERTIFICATION REGARDING LOBBYING

1. List below the names of all persons or entities registered under the federal Lobbying Disclosure Act of 1995, as amended, who have made lobbying contacts on behalf of the Disclosing Party with respect to the Matter: (Add sheets if necessary):

(If no explanation appears or begins on the lines above, or if the letters "NA" or if the word "None" appear, it will be conclusively presumed that the Disclosing Party means that NO persons or entities registered under the Lobbying Disclosure Act of 1995, as amended, have made lobbying contacts on behalf of the Disclosing Party with respect to the Matter.)

2. The Disclosing Party has not spent and will not expend any federally appropriated funds to pay any person or entity listed in paragraph A(1) above for his or her lobbying activities or to pay any person or entity to influence or attempt to influence an officer or employee of any agency, as defined by applicable federal law, a member of Congress, an officer or employee of Congress, or an employee

of a member of Congress, in connection with the award of any federally funded contract, making any federally funded grant or loan, entering into any cooperative agreement, or to extend, continue, renew, amend, or modify any federally funded contract, grant, loan, or cooperative agreement.

3. The Disclosing Party will submit an updated certification at the end of each calendar quarter in which there occurs any event that materially affects the accuracy of the statements and information set forth in paragraphs A(1) and A(2) above.

4. The Disclosing Party certifies that either: (i) it is not an organization described in section 501(c)(4) of the Internal Revenue Code of 1986; or (ii) it is an organization described in section 501(c)(4) of the Internal Revenue Code of 1986 but has not engaged and will not engage in "Lobbying Activities," as that term is defined in the Lobbying Disclosure Act of 1995, as amended.

5. If the Disclosing Party is the Applicant, the Disclosing Party must obtain certifications equal in form and substance to paragraphs A(1) through A(4) above from all subcontractors before it awards any subcontract and the Disclosing Party must maintain all such subcontractors' certifications for the duration of the Matter and must make such certifications promptly available to the City upon request.

B. CERTIFICATION REGARDING EQUAL EMPLOYMENT OPPORTUNITY

If the Matter is federally funded, federal regulations require the Applicant and all proposed subcontractors to submit the following information with their bids or in writing at the outset of negotiations.

Is the Disclosing Party the Applicant?

Yes

No

If "Yes," answer the three questions below:

1. Have you developed and do you have on file affirmative action programs pursuant to applicable federal regulations? (See 41 CFR Part 60-2.)

Yes

No

2. Have you filed with the Joint Reporting Committee, the Director of the Office of Federal Contract Compliance Programs, or the Equal Employment Opportunity Commission all reports due under the applicable filing requirements?

Yes

No

Reports not required

3. Have you participated in any previous contracts or subcontracts subject to the equal opportunity clause?

Yes

No

If you checked "No" to question (1) or (2) above, please provide an explanation:

SECTION VII -- FURTHER ACKNOWLEDGMENTS AND CERTIFICATION

The Disclosing Party understands and agrees that:

A. The certifications, disclosures, and acknowledgments contained in this EDS will become part of any contract or other agreement between the Applicant and the City in connection with the Matter, whether procurement, City assistance, or other City action, and are material inducements to the City's execution of any contract or taking other action with respect to the Matter. The Disclosing Party understands that it must comply with all statutes, ordinances, and regulations on which this EDS is based.

B. The City's Governmental Ethics Ordinance, MCC Chapter 2-156, imposes certain duties and obligations on persons or entities seeking City contracts, work, business, or transactions. The full text of this ordinance and a training program is available on line at www.cityofchicago.org/Ethics, and may also be obtained from the City's Board of Ethics, 740 N. Sedgwick St., Suite 500, Chicago, IL 60610, (312) 744-9660. The Disclosing Party must comply fully with this ordinance.

C. If the City determines that any information provided in this EDS is false, incomplete or inaccurate, any contract or other agreement in connection with which it is submitted may be rescinded or be void or voidable, and the City may pursue any remedies under the contract or agreement (if not rescinded or void), at law, or in equity, including terminating the Disclosing Party's participation in the Matter and/or declining to allow the Disclosing Party to participate in other City transactions. Remedies at law for a false statement of material fact may include incarceration and an award to the City of treble damages.

D. It is the City's policy to make this document available to the public on its Internet site and/or upon request. Some or all of the information provided in, and appended to, this EDS may be made publicly available on the Internet, in response to a Freedom of Information Act request, or otherwise. By completing and signing this EDS, the Disclosing Party waives and releases any possible rights or claims which it may have against the City in connection with the public release of information contained in this EDS and also authorizes the City to verify the accuracy of any information submitted in this EDS.

E. The information provided in this EDS must be kept current. In the event of changes, the Disclosing Party must supplement this EDS up to the time the City takes action on the Matter. If the Matter is a contract being handled by the City's Department of Procurement Services, the Disclosing Party must update this EDS as the contract requires. **NOTE:** With respect to Matters subject to MCC Chapter 1-23, Article I (imposing **PERMANENT INELIGIBILITY** for certain specified offenses), the information provided herein regarding eligibility must be kept current for a longer period, as required by MCC Chapter 1-23 and Section 2-154-020.

CERTIFICATION

Under penalty of perjury, the person signing below: (1) warrants that he/she is authorized to execute this EDS, and all applicable Appendices, on behalf of the Disclosing Party, and (2) warrants that all certifications and statements contained in this EDS, and all applicable Appendices, are true, accurate and complete as of the date furnished to the City.

Chicago Hope Academy

Chicago Hope Academy
(Print or type exact legal name of Disclosing Party)

By: [Signature]
(Sign here)

Robert Muzikowski

Robert Muzikowski
(Print or type name of person signing)

President

President
(Print or type title of person signing)

Signed and sworn to before me on (date) 9-9-2019,

at Cook County, Illinois (state).

[Signature]
Notary Public

Commission expires: 8/3/2023

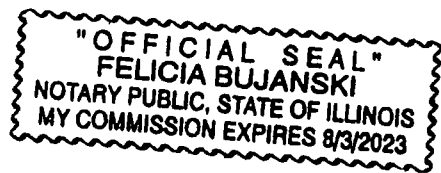

**CITY OF CHICAGO
ECONOMIC DISCLOSURE STATEMENT AND AFFIDAVIT
APPENDIX A**

**FAMILIAL RELATIONSHIPS WITH ELECTED CITY OFFICIALS
AND DEPARTMENT HEADS**

This Appendix is to be completed only by (a) the Applicant, and (b) any legal entity which has a direct ownership interest in the Applicant exceeding 7.5%. It is not to be completed by any legal entity which has only an indirect ownership interest in the Applicant.

Under MCC Section 2-154-015, the Disclosing Party must disclose whether such Disclosing Party or any "Applicable Party" or any Spouse or Domestic Partner thereof currently has a "familial relationship" with any elected city official or department head. A "familial relationship" exists if, as of the date this EDS is signed, the Disclosing Party or any "Applicable Party" or any Spouse or Domestic Partner thereof is related to the mayor, any alderman, the city clerk, the city treasurer or any city department head as spouse or domestic partner or as any of the following, whether by blood or adoption: parent, child, brother or sister, aunt or uncle, niece or nephew, grandparent, grandchild, father-in-law, mother-in-law, son-in-law, daughter-in-law, stepfather or stepmother, stepson or stepdaughter, stepbrother or stepsister or half-brother or half-sister.

"Applicable Party" means (1) all executive officers of the Disclosing Party listed in Section II.B.1.a., if the Disclosing Party is a corporation; all partners of the Disclosing Party, if the Disclosing Party is a general partnership; all general partners and limited partners of the Disclosing Party, if the Disclosing Party is a limited partnership; all managers, managing members and members of the Disclosing Party, if the Disclosing Party is a limited liability company; (2) all principal officers of the Disclosing Party; and (3) any person having more than a 7.5% ownership interest in the Disclosing Party. "Principal officers" means the president, chief operating officer, executive director, chief financial officer, treasurer or secretary of a legal entity or any person exercising similar authority.

Does the Disclosing Party or any "Applicable Party" or any Spouse or Domestic Partner thereof currently have a "familial relationship" with an elected city official or department head?

[] Yes

[x] No

If yes, please identify below (1) the name and title of such person, (2) the name of the legal entity to which such person is connected; (3) the name and title of the elected city official or department head to whom such person has a familial relationship, and (4) the precise nature of such familial relationship.

**CITY OF CHICAGO
ECONOMIC DISCLOSURE STATEMENT AND AFFIDAVIT
APPENDIX B**

BUILDING CODE SCOFFLAW/PROBLEM LANDLORD CERTIFICATION

This Appendix is to be completed only by (a) the Applicant, and (b) any legal entity which has a direct ownership interest in the Applicant exceeding 7.5% (an "Owner"). It is not to be completed by any legal entity which has only an indirect ownership interest in the Applicant.

1. Pursuant to MCC Section 2-154-010, is the Applicant or any Owner identified as a building code scofflaw or problem landlord pursuant to MCC Section 2-92-416?

Yes No

2. If the Applicant is a legal entity publicly traded on any exchange, is any officer or director of the Applicant identified as a building code scofflaw or problem landlord pursuant to MCC Section 2-92-416?

Yes No The Applicant is not publicly traded on any exchange.

3. If yes to (1) or (2) above, please identify below the name of each person or legal entity identified as a building code scofflaw or problem landlord and the address of each building or buildings to which the pertinent code violations apply.

**CITY OF CHICAGO
ECONOMIC DISCLOSURE STATEMENT AND AFFIDAVIT
APPENDIX C**

PROHIBITION ON WAGE & SALARY HISTORY SCREENING - CERTIFICATION

This Appendix is to be completed only by an Applicant that is completing this EDS as a “contractor” as defined in MCC Section 2-92-385. That section, which should be consulted (www.amlegal.com), generally covers a party to any agreement pursuant to which they: (i) receive City of Chicago funds in consideration for services, work or goods provided (including for legal or other professional services), or (ii) pay the City money for a license, grant or concession allowing them to conduct a business on City premises.

On behalf of an Applicant that is a contractor pursuant to MCC Section 2-92-385, I hereby certify that the Applicant is in compliance with MCC Section 2-92-385(b)(1) and (2), which prohibit: (i) screening job applicants based on their wage or salary history, or (ii) seeking job applicants’ wage or salary history from current or former employers. I also certify that the Applicant has adopted a policy that includes those prohibitions.

Yes

No

N/A – I am not an Applicant that is a “contractor” as defined in MCC Section 2-92-385.

This certification shall serve as the affidavit required by MCC Section 2-92-385(c)(1).

If you checked “no” to the above, please explain.

**CITY OF CHICAGO
ECONOMIC DISCLOSURE STATEMENT
AND AFFIDAVIT**

SECTION I -- GENERAL INFORMATION

A. Legal name of the Disclosing Party submitting this EDS. Include d/b/a/ if applicable:

Chicago Lions Charitable Association

Check ONE of the following three boxes:

Indicate whether the Disclosing Party submitting this EDS is:

1. the Applicant

OR

2. a legal entity currently holding, or anticipated to hold within six months after City action on the contract, transaction or other undertaking to which this EDS pertains (referred to below as the "Matter"), a direct or indirect interest in excess of 7.5% in the Applicant. State the Applicant's legal name: _____

OR

3. a legal entity with a direct or indirect right of control of the Applicant (see Section II(B)(1)) State the legal name of the entity in which the Disclosing Party holds a right of control: _____

B. Business address of the Disclosing Party:

PO Box 532

Northbrook, IL 60065

C. Telephone: 847-921-0872 Fax: _____ Email: clca@chicagolions.com

D. Name of contact person: Jeff Simon

E. Federal Employer Identification No. (if you have one): _____

F. Brief description of the Matter to which this EDS pertains. (Include project number and location of property, if applicable):

~~Planned Development application for the property bounded by West Harrison Street on the north, South Washtenaw Avenue on the east, West Taylor Street on the south and the elevated portion of the Union Pacific Railroad on the east (identified as Parcel A on attached map)~~

G. Which City agency or department is requesting this EDS? Department of Planning & Development

If the Matter is a contract being handled by the City's Department of Procurement Services, please complete the following:

Specification # _____ and Contract # _____

SECTION II -- DISCLOSURE OF OWNERSHIP INTERESTS

A. NATURE OF THE DISCLOSING PARTY

1. Indicate the nature of the Disclosing Party:

- | | |
|---|---|
| <input type="checkbox"/> Person | <input type="checkbox"/> Limited liability company |
| <input type="checkbox"/> Publicly registered business corporation | <input type="checkbox"/> Limited liability partnership |
| <input type="checkbox"/> Privately held business corporation | <input type="checkbox"/> Joint venture |
| <input type="checkbox"/> Sole proprietorship | <input checked="" type="checkbox"/> Not-for-profit corporation |
| <input type="checkbox"/> General partnership | (Is the not-for-profit corporation also a 501(c)(3))? |
| <input type="checkbox"/> Limited partnership | <input checked="" type="checkbox"/> Yes <input type="checkbox"/> No |
| <input type="checkbox"/> Trust | <input type="checkbox"/> Other (please specify) |
-

2. For legal entities, the state (or foreign country) of incorporation or organization, if applicable:

Illinois

3. For legal entities not organized in the State of Illinois: Has the organization registered to do business in the State of Illinois as a foreign entity?

- Yes No Organized in Illinois

B. IF THE DISCLOSING PARTY IS A LEGAL ENTITY:

1. List below the full names and titles, if applicable, of: (i) all executive officers and all directors of the entity; (ii) **for not-for-profit corporations**, all members, if any, which are legal entities (if there are no such members, write "no members which are legal entities"); (iii) **for trusts, estates or other similar entities**, the trustee, executor, administrator, or similarly situated party; (iv) **for general or limited partnerships, limited liability companies, limited liability partnerships or joint ventures**, each general partner, managing member, manager or any other person or legal entity that directly or indirectly controls the day-to-day management of the Applicant.

NOTE: Each legal entity listed below must submit an EDS on its own behalf.

Name	Title
------	-------

See attached list of officers and directors (none are legal entities)

2. Please provide the following information concerning each person or legal entity having a direct or indirect, current or prospective (i.e. within 6 months after City action) beneficial interest (including ownership) in excess of 7.5% of the Applicant. Examples of such an interest include shares in a corporation, partnership interest in a partnership or joint venture, interest of a member or manager in a

limited liability company, or interest of a beneficiary of a trust, estate or other similar entity. If none, state "None."

NOTE: Each legal entity listed below may be required to submit an EDS on its own behalf.

Name	Business Address	Percentage Interest in the Applicant
None		

SECTION III -- INCOME OR COMPENSATION TO, OR OWNERSHIP BY, CITY ELECTED OFFICIALS

Has the Disclosing Party provided any income or compensation to any City elected official during the 12-month period preceding the date of this EDS? [] Yes [x] No

Does the Disclosing Party reasonably expect to provide any income or compensation to any City elected official during the 12-month period following the date of this EDS? [] Yes [x] No

If "yes" to either of the above, please identify below the name(s) of such City elected official(s) and describe such income or compensation:

Does any City elected official or, to the best of the Disclosing Party's knowledge after reasonable inquiry, any City elected official's spouse or domestic partner, have a financial interest (as defined in Chapter 2-156 of the Municipal Code of Chicago ("MCC")) in the Disclosing Party? [] Yes [x] No

If "yes," please identify below the name(s) of such City elected official(s) and/or spouse(s)/domestic partner(s) and describe the financial interest(s).

SECTION IV -- DISCLOSURE OF SUBCONTRACTORS AND OTHER RETAINED PARTIES

The Disclosing Party must disclose the name and business address of each subcontractor, attorney, lobbyist (as defined in MCC Chapter 2-156), accountant, consultant and any other person or entity whom the Disclosing Party has retained or expects to retain in connection with the Matter, as well as the nature of the relationship, and the total amount of the fees paid or estimated to be paid. The Disclosing Party is not required to disclose employees who are paid solely through the Disclosing Party's regular payroll. If the Disclosing Party is uncertain whether a disclosure is required under this Section, the Disclosing Party must either ask the City whether disclosure is required or make the disclosure.



Chicago Lions
CHARITABLE ASSOCIATION

Board members as of 8-12-19:

Jeffrey C. Simon - President
2535 Windsor Lane
Northbrook, IL 60062

Allie Movrich - Director
4144 N. Sheridan Road Unit 210
Chicago, IL 60613

George Plackmann - Secretary
3011 N Ashland Ave #3S
Chicago, IL 60657

Patrick O'Reilly - Director
17715 curry branch Road
Louisville, KY 40245

Brian Rooney - Director
2827 N Central Park Ave
Chicago, IL 60618

Chicago Lions Charitable Association

Mailing Address: PO Box 532 | Northbrook, IL | 60065

Physical Address: 2637 W Polk | Chicago, IL | 60612

www.chicagolions.com | www.lionsforhopesc.org

Name (indicate whether retained or anticipated to be retained)	Business Address	Relationship to Disclosing Party (subcontractor, attorney, lobbyist, etc.)	Fees (<u>indicate whether paid or estimated.</u>) NOTE: "hourly rate" or "t.b.d." is not an acceptable response.
--	------------------	--	---

(Add sheets if necessary)

Check here if the Disclosing Party has not retained, nor expects to retain, any such persons or entities.

SECTION V -- CERTIFICATIONS

A. COURT-ORDERED CHILD SUPPORT COMPLIANCE

Under MCC Section 2-92-415, substantial owners of business entities that contract with the City must remain in compliance with their child support obligations throughout the contract's term.

Has any person who directly or indirectly owns 10% or more of the Disclosing Party been declared in arrearage on any child support obligations by any Illinois court of competent jurisdiction?

Yes No No person directly or indirectly owns 10% or more of the Disclosing Party.

If "Yes," has the person entered into a court-approved agreement for payment of all support owed and is the person in compliance with that agreement?

Yes No

B. FURTHER CERTIFICATIONS

1. [This paragraph 1 applies only if the Matter is a contract being handled by the City's Department of Procurement Services.] In the 5-year period preceding the date of this EDS, neither the Disclosing Party nor any Affiliated Entity [see definition in (5) below] has engaged, in connection with the performance of any public contract, the services of an integrity monitor, independent private sector inspector general, or integrity compliance consultant (i.e., an individual or entity with legal, auditing, investigative, or other similar skills, designated by a public agency to help the agency monitor the activity of specified agency vendors as well as help the vendors reform their business practices so they can be considered for agency contracts in the future, or continue with a contract in progress).

2. The Disclosing Party and its Affiliated Entities are not delinquent in the payment of any fine, fee, tax or other source of indebtedness owed to the City of Chicago, including, but not limited to, water and sewer charges, license fees, parking tickets, property taxes and sales taxes, nor is the Disclosing Party delinquent in the payment of any tax administered by the Illinois Department of Revenue.

3. The Disclosing Party and, if the Disclosing Party is a legal entity, all of those persons or entities identified in Section II(B)(1) of this EDS:

- a. are not presently debarred, suspended, proposed for debarment, declared ineligible or voluntarily excluded from any transactions by any federal, state or local unit of government;
- b. have not, during the 5 years before the date of this EDS, been convicted of a criminal offense, adjudged guilty, or had a civil judgment rendered against them in connection with: obtaining, attempting to obtain, or performing a public (federal, state or local) transaction or contract under a public transaction; a violation of federal or state antitrust statutes; fraud; embezzlement; theft; forgery; bribery; falsification or destruction of records; making false statements; or receiving stolen property;
- c. are not presently indicted for, or criminally or civilly charged by, a governmental entity (federal, state or local) with committing any of the offenses set forth in subparagraph (b) above;
- d. have not, during the 5 years before the date of this EDS, had one or more public transactions (federal, state or local) terminated for cause or default; and
- e. have not, during the 5 years before the date of this EDS, been convicted, adjudged guilty, or found liable in a civil proceeding, or in any criminal or civil action, including actions concerning environmental violations, instituted by the City or by the federal government, any state, or any other unit of local government.

4. The Disclosing Party understands and shall comply with the applicable requirements of MCC Chapters 2-56 (Inspector General) and 2-156 (Governmental Ethics).

5. Certifications (5), (6) and (7) concern:

- the Disclosing Party;
- any "Contractor" (meaning any contractor or subcontractor used by the Disclosing Party in connection with the Matter, including but not limited to all persons or legal entities disclosed under Section IV, "Disclosure of Subcontractors and Other Retained Parties");
- any "Affiliated Entity" (meaning a person or entity that, directly or indirectly: controls the Disclosing Party, is controlled by the Disclosing Party, or is, with the Disclosing Party, under common control of another person or entity). Indicia of control include, without limitation: interlocking management or ownership; identity of interests among family members, shared facilities and equipment; common use of employees; or organization of a business entity following the ineligibility of a business entity to do business with federal or state or local government, including the City, using substantially the same management, ownership, or principals as the ineligible entity. With respect to Contractors, the term Affiliated Entity means a person or entity that directly or indirectly controls the Contractor, is controlled by it, or, with the Contractor, is under common control of another person or entity;
- any responsible official of the Disclosing Party, any Contractor or any Affiliated Entity or any other official, agent or employee of the Disclosing Party, any Contractor or any Affiliated Entity, acting pursuant to the direction or authorization of a responsible official of the Disclosing Party, any Contractor or any Affiliated Entity (collectively "Agents").

Neither the Disclosing Party, nor any Contractor, nor any Affiliated Entity of either the Disclosing Party or any Contractor, nor any Agents have, during the 5 years before the date of this EDS, or, with respect to a Contractor, an Affiliated Entity, or an Affiliated Entity of a Contractor during the 5 years before the date of such Contractor's or Affiliated Entity's contract or engagement in connection with the Matter:

- a. bribed or attempted to bribe, or been convicted or adjudged guilty of bribery or attempting to bribe, a public officer or employee of the City, the State of Illinois, or any agency of the federal government or of any state or local government in the United States of America, in that officer's or employee's official capacity;
- b. agreed or colluded with other bidders or prospective bidders, or been a party to any such agreement, or been convicted or adjudged guilty of agreement or collusion among bidders or prospective bidders, in restraint of freedom of competition by agreement to bid a fixed price or otherwise; or
- c. made an admission of such conduct described in subparagraph (a) or (b) above that is a matter of record, but have not been prosecuted for such conduct; or
- d. violated the provisions referenced in MCC Subsection 2-92-320(a)(4)(Contracts Requiring a Base Wage); (a)(5)(Debarment Regulations); or (a)(6)(Minimum Wage Ordinance).

6. Neither the Disclosing Party, nor any Affiliated Entity or Contractor, or any of their employees, officials, agents or partners, is barred from contracting with any unit of state or local government as a result of engaging in or being convicted of (1) bid-rigging in violation of 720 ILCS 5/33E-3; (2) bid-rotating in violation of 720 ILCS 5/33E-4; or (3) any similar offense of any state or of the United States of America that contains the same elements as the offense of bid-rigging or bid-rotating.

7. Neither the Disclosing Party nor any Affiliated Entity is listed on a Sanctions List maintained by the United States Department of Commerce, State, or Treasury, or any successor federal agency.

8. [FOR APPLICANT ONLY] (i) Neither the Applicant nor any "controlling person" [see MCC Chapter 1-23, Article I for applicability and defined terms] of the Applicant is currently indicted or charged with, or has admitted guilt of, or has ever been convicted of, or placed under supervision for, any criminal offense involving actual, attempted, or conspiracy to commit bribery, theft, fraud, forgery, perjury, dishonesty or deceit against an officer or employee of the City or any "sister agency"; and (ii) the Applicant understands and acknowledges that compliance with Article I is a continuing requirement for doing business with the City. NOTE: If MCC Chapter 1-23, Article I applies to the Applicant, that Article's permanent compliance timeframe supersedes 5-year compliance timeframes in this Section V.

9. [FOR APPLICANT ONLY] The Applicant and its Affiliated Entities will not use, nor permit their subcontractors to use, any facility listed as having an active exclusion by the U.S. EPA on the federal System for Award Management ("SAM").

10. [FOR APPLICANT ONLY] The Applicant will obtain from any contractors/subcontractors hired or to be hired in connection with the Matter certifications equal in form and substance to those in Certifications (2) and (9) above and will not, without the prior written consent of the City, use any such

contractor/subcontractor that does not provide such certifications or that the Applicant has reason to believe has not provided or cannot provide truthful certifications.

11. If the Disclosing Party is unable to certify to any of the above statements in this Part B (Further Certifications), the Disclosing Party must explain below:

NA

If the letters "NA," the word "None," or no response appears on the lines above, it will be conclusively presumed that the Disclosing Party certified to the above statements.

12. To the best of the Disclosing Party's knowledge after reasonable inquiry, the following is a complete list of all current employees of the Disclosing Party who were, at any time during the 12-month period preceding the date of this EDS, an employee, or elected or appointed official, of the City of Chicago (if none, indicate with "N/A" or "none").

NA

13. To the best of the Disclosing Party's knowledge after reasonable inquiry, the following is a complete list of all gifts that the Disclosing Party has given or caused to be given, at any time during the 12-month period preceding the execution date of this EDS, to an employee, or elected or appointed official, of the City of Chicago. For purposes of this statement, a "gift" does not include: (i) anything made generally available to City employees or to the general public, or (ii) food or drink provided in the course of official City business and having a retail value of less than \$25 per recipient, or (iii) a political contribution otherwise duly reported as required by law (if none, indicate with "N/A" or "none"). As to any gift listed below, please also list the name of the City recipient.

NA

C. CERTIFICATION OF STATUS AS FINANCIAL INSTITUTION

1. The Disclosing Party certifies that the Disclosing Party (check one)

is is not

a "financial institution" as defined in MCC Section 2-32-455(b).

2. If the Disclosing Party IS a financial institution, then the Disclosing Party pledges:

"We are not and will not become a predatory lender as defined in MCC Chapter 2-32. We further pledge that none of our affiliates is, and none of them will become, a predatory lender as defined in MCC Chapter 2-32. We understand that becoming a predatory lender or becoming an affiliate of a predatory lender may result in the loss of the privilege of doing business with the City."

If the Disclosing Party is unable to make this pledge because it or any of its affiliates (as defined in MCC Section 2-32-455(b)) is a predatory lender within the meaning of MCC Chapter 2-32, explain here (attach additional pages if necessary):

If the letters "NA," the word "None," or no response appears on the lines above, it will be conclusively presumed that the Disclosing Party certified to the above statements.

D. CERTIFICATION REGARDING FINANCIAL INTEREST IN CITY BUSINESS

Any words or terms defined in MCC Chapter 2-156 have the same meanings if used in this Part D.

1. In accordance with MCC Section 2-156-110: To the best of the Disclosing Party's knowledge after reasonable inquiry, does any official or employee of the City have a financial interest in his or her own name or in the name of any other person or entity in the Matter?

Yes No

NOTE: If you checked "Yes" to Item D(1), proceed to Items D(2) and D(3). If you checked "No" to Item D(1), skip Items D(2) and D(3) and proceed to Part E.

2. Unless sold pursuant to a process of competitive bidding, or otherwise permitted, no City elected official or employee shall have a financial interest in his or her own name or in the name of any other person or entity in the purchase of any property that (i) belongs to the City, or (ii) is sold for taxes or assessments, or (iii) is sold by virtue of legal process at the suit of the City (collectively, "City Property Sale"). Compensation for property taken pursuant to the City's eminent domain power does not constitute a financial interest within the meaning of this Part D.

Does the Matter involve a City Property Sale?

Yes No

3. If you checked "Yes" to Item D(1), provide the names and business addresses of the City officials or employees having such financial interest and identify the nature of the financial interest:

Name	Business Address	Nature of Financial Interest
------	------------------	------------------------------

4. The Disclosing Party further certifies that no prohibited financial interest in the Matter will be acquired by any City official or employee.

E. CERTIFICATION REGARDING SLAVERY ERA BUSINESS

Please check either (1) or (2) below. If the Disclosing Party checks (2), the Disclosing Party must disclose below or in an attachment to this EDS all information required by (2). Failure to comply with these disclosure requirements may make any contract entered into with the City in connection with the Matter voidable by the City.

 x 1. The Disclosing Party verifies that the Disclosing Party has searched any and all records of the Disclosing Party and any and all predecessor entities regarding records of investments or profits from slavery or slaveholder insurance policies during the slavery era (including insurance policies issued to slaveholders that provided coverage for damage to or injury or death of their slaves), and the Disclosing Party has found no such records.

 2. The Disclosing Party verifies that, as a result of conducting the search in step (1) above, the Disclosing Party has found records of investments or profits from slavery or slaveholder insurance policies. The Disclosing Party verifies that the following constitutes full disclosure of all such records, including the names of any and all slaves or slaveholders described in those records:

SECTION VI -- CERTIFICATIONS FOR FEDERALLY FUNDED MATTERS

NOTE: If the Matter is federally funded, complete this Section VI. If the Matter is not federally funded, proceed to Section VII. For purposes of this Section VI, tax credits allocated by the City and proceeds of debt obligations of the City are not federal funding.

A. CERTIFICATION REGARDING LOBBYING

1. List below the names of all persons or entities registered under the federal Lobbying Disclosure Act of 1995, as amended, who have made lobbying contacts on behalf of the Disclosing Party with respect to the Matter: (Add sheets if necessary):

(If no explanation appears or begins on the lines above, or if the letters "NA" or if the word "None" appear, it will be conclusively presumed that the Disclosing Party means that NO persons or entities registered under the Lobbying Disclosure Act of 1995, as amended, have made lobbying contacts on behalf of the Disclosing Party with respect to the Matter.)

2. The Disclosing Party has not spent and will not expend any federally appropriated funds to pay any person or entity listed in paragraph A(1) above for his or her lobbying activities or to pay any person or entity to influence or attempt to influence an officer or employee of any agency, as defined by applicable federal law, a member of Congress, an officer or employee of Congress, or an employee

of a member of Congress, in connection with the award of any federally funded contract, making any federally funded grant or loan, entering into any cooperative agreement, or to extend, continue, renew, amend, or modify any federally funded contract, grant, loan, or cooperative agreement.

3. The Disclosing Party will submit an updated certification at the end of each calendar quarter in which there occurs any event that materially affects the accuracy of the statements and information set forth in paragraphs A(1) and A(2) above.

4. The Disclosing Party certifies that either: (i) it is not an organization described in section 501(c)(4) of the Internal Revenue Code of 1986; or (ii) it is an organization described in section 501(c)(4) of the Internal Revenue Code of 1986 but has not engaged and will not engage in "Lobbying Activities," as that term is defined in the Lobbying Disclosure Act of 1995, as amended.

5. If the Disclosing Party is the Applicant, the Disclosing Party must obtain certifications equal in form and substance to paragraphs A(1) through A(4) above from all subcontractors before it awards any subcontract and the Disclosing Party must maintain all such subcontractors' certifications for the duration of the Matter and must make such certifications promptly available to the City upon request.

B. CERTIFICATION REGARDING EQUAL EMPLOYMENT OPPORTUNITY

If the Matter is federally funded, federal regulations require the Applicant and all proposed subcontractors to submit the following information with their bids or in writing at the outset of negotiations.

Is the Disclosing Party the Applicant?

Yes

No

If "Yes," answer the three questions below:

1. Have you developed and do you have on file affirmative action programs pursuant to applicable federal regulations? (See 41 CFR Part 60-2.)

Yes

No

2. Have you filed with the Joint Reporting Committee, the Director of the Office of Federal Contract Compliance Programs, or the Equal Employment Opportunity Commission all reports due under the applicable filing requirements?

Yes

No

Reports not required

3. Have you participated in any previous contracts or subcontracts subject to the equal opportunity clause?

Yes

No

If you checked "No" to question (1) or (2) above, please provide an explanation:

SECTION VII -- FURTHER ACKNOWLEDGMENTS AND CERTIFICATION

The Disclosing Party understands and agrees that:

A. The certifications, disclosures, and acknowledgments contained in this EDS will become part of any contract or other agreement between the Applicant and the City in connection with the Matter, whether procurement, City assistance, or other City action, and are material inducements to the City's execution of any contract or taking other action with respect to the Matter. The Disclosing Party understands that it must comply with all statutes, ordinances, and regulations on which this EDS is based.

B. The City's Governmental Ethics Ordinance, MCC Chapter 2-156, imposes certain duties and obligations on persons or entities seeking City contracts, work, business, or transactions. The full text of this ordinance and a training program is available on line at www.cityofchicago.org/Ethics, and may also be obtained from the City's Board of Ethics, 740 N. Sedgwick St., Suite 500, Chicago, IL 60610, (312) 744-9660. The Disclosing Party must comply fully with this ordinance.

C. If the City determines that any information provided in this EDS is false, incomplete or inaccurate, any contract or other agreement in connection with which it is submitted may be rescinded or be void or voidable, and the City may pursue any remedies under the contract or agreement (if not rescinded or void), at law, or in equity, including terminating the Disclosing Party's participation in the Matter and/or declining to allow the Disclosing Party to participate in other City transactions. Remedies at law for a false statement of material fact may include incarceration and an award to the City of treble damages.

D. It is the City's policy to make this document available to the public on its Internet site and/or upon request. Some or all of the information provided in, and appended to, this EDS may be made publicly available on the Internet, in response to a Freedom of Information Act request, or otherwise. By completing and signing this EDS, the Disclosing Party waives and releases any possible rights or claims which it may have against the City in connection with the public release of information contained in this EDS and also authorizes the City to verify the accuracy of any information submitted in this EDS.

E. The information provided in this EDS must be kept current. In the event of changes, the Disclosing Party must supplement this EDS up to the time the City takes action on the Matter. If the Matter is a contract being handled by the City's Department of Procurement Services, the Disclosing Party must update this EDS as the contract requires. **NOTE:** With respect to Matters subject to MCC Chapter 1-23, Article I (imposing **PERMANENT INELIGIBILITY** for certain specified offenses), the information provided herein regarding eligibility must be kept current for a longer period, as required by MCC Chapter 1-23 and Section 2-154-020.

CERTIFICATION

Under penalty of perjury, the person signing below: (1) warrants that he/she is authorized to execute this EDS, and all applicable Appendices, on behalf of the Disclosing Party, and (2) warrants that all certifications and statements contained in this EDS, and all applicable Appendices, are true, accurate and complete as of the date furnished to the City.

Chicago Lions Charitable Association

(Print or type exact legal name of Disclosing Party)

By: Jeff Simon
(Sign here)

Jeff Simon

(Print or type name of person signing)

President

(Print or type title of person signing)

Signed and sworn to before me on (date) 9-9-2019,

at Cook County, Illinois (state).

Felicia Bujanski
Notary Public

Commission expires: 8/3/2023



**CITY OF CHICAGO
ECONOMIC DISCLOSURE STATEMENT AND AFFIDAVIT
APPENDIX A**

**FAMILIAL RELATIONSHIPS WITH ELECTED CITY OFFICIALS
AND DEPARTMENT HEADS**

This Appendix is to be completed only by (a) the Applicant, and (b) any legal entity which has a direct ownership interest in the Applicant exceeding 7.5%. It is not to be completed by any legal entity which has only an indirect ownership interest in the Applicant.

Under MCC Section 2-154-015, the Disclosing Party must disclose whether such Disclosing Party or any "Applicable Party" or any Spouse or Domestic Partner thereof currently has a "familial relationship" with any elected city official or department head. A "familial relationship" exists if, as of the date this EDS is signed, the Disclosing Party or any "Applicable Party" or any Spouse or Domestic Partner thereof is related to the mayor, any alderman, the city clerk, the city treasurer or any city department head as spouse or domestic partner or as any of the following, whether by blood or adoption: parent, child, brother or sister, aunt or uncle, niece or nephew, grandparent, grandchild, father-in-law, mother-in-law, son-in-law, daughter-in-law, stepfather or stepmother, stepson or stepdaughter, stepbrother or stepsister or half-brother or half-sister.

"Applicable Party" means (1) all executive officers of the Disclosing Party listed in Section II.B.1.a., if the Disclosing Party is a corporation; all partners of the Disclosing Party, if the Disclosing Party is a general partnership; all general partners and limited partners of the Disclosing Party, if the Disclosing Party is a limited partnership; all managers, managing members and members of the Disclosing Party, if the Disclosing Party is a limited liability company; (2) all principal officers of the Disclosing Party; and (3) any person having more than a 7.5% ownership interest in the Disclosing Party. "Principal officers" means the president, chief operating officer, executive director, chief financial officer, treasurer or secretary of a legal entity or any person exercising similar authority.

Does the Disclosing Party or any "Applicable Party" or any Spouse or Domestic Partner thereof currently have a "familial relationship" with an elected city official or department head?

[] Yes

[x] No

If yes, please identify below (1) the name and title of such person, (2) the name of the legal entity to which such person is connected; (3) the name and title of the elected city official or department head to whom such person has a familial relationship, and (4) the precise nature of such familial relationship.

**CITY OF CHICAGO
ECONOMIC DISCLOSURE STATEMENT AND AFFIDAVIT
APPENDIX B**

BUILDING CODE SCOFFLAW/PROBLEM LANDLORD CERTIFICATION

This Appendix is to be completed only by (a) the Applicant, and (b) any legal entity which has a direct ownership interest in the Applicant exceeding 7.5% (an "Owner"). It is not to be completed by any legal entity which has only an indirect ownership interest in the Applicant.

1. Pursuant to MCC Section 2-154-010, is the Applicant or any Owner identified as a building code scofflaw or problem landlord pursuant to MCC Section 2-92-416?

Yes No

2. If the Applicant is a legal entity publicly traded on any exchange, is any officer or director of the Applicant identified as a building code scofflaw or problem landlord pursuant to MCC Section 2-92-416?

Yes No The Applicant is not publicly traded on any exchange.

3. If yes to (1) or (2) above, please identify below the name of each person or legal entity identified as a building code scofflaw or problem landlord and the address of each building or buildings to which the pertinent code violations apply.

**CITY OF CHICAGO
ECONOMIC DISCLOSURE STATEMENT AND AFFIDAVIT
APPENDIX C**

PROHIBITION ON WAGE & SALARY HISTORY SCREENING - CERTIFICATION

This Appendix is to be completed only by an Applicant that is completing this EDS as a “contractor” as defined in MCC Section 2-92-385. That section, which should be consulted (www.amlegal.com), generally covers a party to any agreement pursuant to which they: (i) receive City of Chicago funds in consideration for services, work or goods provided (including for legal or other professional services), or (ii) pay the City money for a license, grant or concession allowing them to conduct a business on City premises.

On behalf of an Applicant that is a contractor pursuant to MCC Section 2-92-385, I hereby certify that the Applicant is in compliance with MCC Section 2-92-385(b)(1) and (2), which prohibit: (i) screening job applicants based on their wage or salary history, or (ii) seeking job applicants’ wage or salary history from current or former employers. I also certify that the Applicant has adopted a policy that includes those prohibitions.

Yes

No

N/A – I am not an Applicant that is a “contractor” as defined in MCC Section 2-92-385.

This certification shall serve as the affidavit required by MCC Section 2-92-385(c)(1).

If you checked “no” to the above, please explain.

**CITY OF CHICAGO
ECONOMIC DISCLOSURE STATEMENT
AND AFFIDAVIT**

SECTION I -- GENERAL INFORMATION

A. Legal name of the Disclosing Party submitting this EDS. Include d/b/a/ if applicable:

Ringgold Capital IV, LLC

Check ONE of the following three boxes:

Indicate whether the Disclosing Party submitting this EDS is:

1. the Owner of 2641 W. Harrison St., Chicago, IL 60612

OR

2. a legal entity currently holding, or anticipated to hold within six months after City action on the contract, transaction or other undertaking to which this EDS pertains (referred to below as the "Matter"), a direct or indirect interest in excess of 7.5% in the Applicant. State the Applicant's legal name: _____

OR

3. a legal entity with a direct or indirect right of control of the Applicant (see Section II(B)(1)) State the legal name of the entity in which the Disclosing Party holds a right of control: _____

B. Business address of the Disclosing Party: 227 West Monroe St, Suite 5000
Chicago, IL 60606

C. Telephone: (312) 977-4330 Fax: (312) 277-7498 Email: robert.fedoris@franklinmonroe.com

D. Name of contact person: Robert Fedoris

E. Federal Employer Identification No. (if you have one): _____

F. Brief description of the Matter to which this EDS pertains. (Include project number and location of property, if applicable):

Planned Development application for the property bounded by West Harrison on the north, South Washtenaw on the east, West Taylor Street on the south and the elevated portion of the Union Pacific Railroad on the east (identified as Parcel A on the attached map) Please note that Parcel A (attached) is the Sidwell map identifying the properties which will be included in the proposed PD zoning designation.

G. Which City agency or department is requesting this EDS? Department of Planning and Development

If the Matter is a contract being handled by the City's Department of Procurement Services, please complete the following:

Specification # _____ and Contract # _____

SECTION II -- DISCLOSURE OF OWNERSHIP INTERESTS

A. NATURE OF THE DISCLOSING PARTY

1. Indicate the nature of the Disclosing Party:

- Person
- Limited liability company
- Publicly registered business corporation
- Limited liability partnership
- Privately held business corporation
- Joint venture
- Sole proprietorship
- Not-for-profit corporation
- General partnership
- (Is the not-for-profit corporation also a 501(c)(3))?
- Limited partnership
- Yes No
- Trust
- Other (please specify)

2. For legal entities, the state (or foreign country) of incorporation or organization, if applicable:

Delaware

3. For legal entities not organized in the State of Illinois: Has the organization registered to do business in the State of Illinois as a foreign entity?

- Yes
- No
- Organized in Illinois

B. IF THE DISCLOSING PARTY IS A LEGAL ENTITY:

1. List below the full names and titles, if applicable, of: (i) all executive officers and all directors of the entity; (ii) **for not-for-profit corporations**, all members, if any, which are legal entities (if there are no such members, write "no members which are legal entities"); (iii) **for trusts, estates or other similar entities**, the trustee, executor, administrator, or similarly situated party; (iv) **for general or limited partnerships, limited liability companies, limited liability partnerships or joint ventures**, each general partner, managing member, manager or any other person or legal entity that directly or indirectly controls the day-to-day management of the Applicant.

NOTE: Each legal entity listed below must submit an EDS on its own behalf.

Name	Title
Robert Fedoris	Member/Manager

2. Please provide the following information concerning each person or legal entity having a direct or indirect, current or prospective (i.e. within 6 months after City action) beneficial interest (including ownership) in excess of 7.5% of the Applicant. Examples of such an interest include shares in a corporation, partnership interest in a partnership or joint venture, interest of a member or manager in a

limited liability company, or interest of a beneficiary of a trust, estate or other similar entity. If none, state "None."

NOTE: Each legal entity listed below may be required to submit an EDS on its own behalf.

Name	Business Address	Percentage Interest in the Applicant
Robert Fedoris	1045 First Avenue, Suite 120	100%
	King of Prussia, PA 19406	

SECTION III -- INCOME OR COMPENSATION TO, OR OWNERSHIP BY, CITY ELECTED OFFICIALS

Has the Disclosing Party provided any income or compensation to any City elected official during the 12-month period preceding the date of this EDS? Yes No

Does the Disclosing Party reasonably expect to provide any income or compensation to any City elected official during the 12-month period following the date of this EDS? Yes No

If "yes" to either of the above, please identify below the name(s) of such City elected official(s) and describe such income or compensation:

Does any City elected official or, to the best of the Disclosing Party's knowledge after reasonable inquiry, any City elected official's spouse or domestic partner, have a financial interest (as defined in Chapter 2-156 of the Municipal Code of Chicago ("MCC")) in the Disclosing Party?

Yes No

If "yes," please identify below the name(s) of such City elected official(s) and/or spouse(s)/domestic partner(s) and describe the financial interest(s).

SECTION IV -- DISCLOSURE OF SUBCONTRACTORS AND OTHER RETAINED PARTIES

The Disclosing Party must disclose the name and business address of each subcontractor, attorney, lobbyist (as defined in MCC Chapter 2-156), accountant, consultant and any other person or entity whom the Disclosing Party has retained or expects to retain in connection with the Matter, as well as the nature of the relationship, and the total amount of the fees paid or estimated to be paid. The Disclosing Party is not required to disclose employees who are paid solely through the Disclosing Party's regular payroll. If the Disclosing Party is uncertain whether a disclosure is required under this Section, the Disclosing Party must either ask the City whether disclosure is required or make the disclosure.

Name (indicate whether retained or anticipated to be retained)	Business Address	Relationship to Disclosing Party (subcontractor, attorney, lobbyist, etc.)	Fees (<u>indicate whether paid or estimated.</u>) NOTE: "hourly rate" or "t.b.d." is not an acceptable response.
--	------------------	--	---

(Add sheets if necessary)

Check here if the Disclosing Party has not retained, nor expects to retain, any such persons or entities.

SECTION V -- CERTIFICATIONS

A. COURT-ORDERED CHILD SUPPORT COMPLIANCE

Under MCC Section 2-92-415, substantial owners of business entities that contract with the City must remain in compliance with their child support obligations throughout the contract's term.

Has any person who directly or indirectly owns 10% or more of the Disclosing Party been declared in arrearage on any child support obligations by any Illinois court of competent jurisdiction?

Yes No No person directly or indirectly owns 10% or more of the Disclosing Party.

If "Yes," has the person entered into a court-approved agreement for payment of all support owed and is the person in compliance with that agreement?

Yes No

B. FURTHER CERTIFICATIONS

1. [This paragraph 1 applies only if the Matter is a contract being handled by the City's Department of Procurement Services.] In the 5-year period preceding the date of this EDS, neither the Disclosing Party nor any Affiliated Entity [see definition in (5) below] has engaged, in connection with the performance of any public contract, the services of an integrity monitor, independent private sector inspector general, or integrity compliance consultant (i.e., an individual or entity with legal, auditing, investigative, or other similar skills, designated by a public agency to help the agency monitor the activity of specified agency vendors as well as help the vendors reform their business practices so they can be considered for agency contracts in the future, or continue with a contract in progress).

2. The Disclosing Party and its Affiliated Entities are not delinquent in the payment of any fine, fee, tax or other source of indebtedness owed to the City of Chicago, including, but not limited to, water and sewer charges, license fees, parking tickets, property taxes and sales taxes, nor is the Disclosing Party delinquent in the payment of any tax administered by the Illinois Department of Revenue.

3. The Disclosing Party and, if the Disclosing Party is a legal entity, all of those persons or entities identified in Section II(B)(1) of this EDS:
- a. are not presently debarred, suspended, proposed for debarment, declared ineligible or voluntarily excluded from any transactions by any federal, state or local unit of government;
 - b. have not, during the 5 years before the date of this EDS, been convicted of a criminal offense, adjudged guilty, or had a civil judgment rendered against them in connection with: obtaining, attempting to obtain, or performing a public (federal, state or local) transaction or contract under a public transaction; a violation of federal or state antitrust statutes; fraud; embezzlement; theft; forgery; bribery; falsification or destruction of records; making false statements; or receiving stolen property;
 - c. are not presently indicted for, or criminally or civilly charged by, a governmental entity (federal, state or local) with committing any of the offenses set forth in subparagraph (b) above;
 - d. have not, during the 5 years before the date of this EDS, had one or more public transactions (federal, state or local) terminated for cause or default; and
 - e. have not, during the 5 years before the date of this EDS, been convicted, adjudged guilty, or found liable in a civil proceeding, or in any criminal or civil action, including actions concerning environmental violations, instituted by the City or by the federal government, any state, or any other unit of local government.
4. The Disclosing Party understands and shall comply with the applicable requirements of MCC Chapters 2-56 (Inspector General) and 2-156 (Governmental Ethics).
5. Certifications (5), (6) and (7) concern:
- the Disclosing Party;
 - any "Contractor" (meaning any contractor or subcontractor used by the Disclosing Party in connection with the Matter, including but not limited to all persons or legal entities disclosed under Section IV, "Disclosure of Subcontractors and Other Retained Parties");
 - any "Affiliated Entity" (meaning a person or entity that, directly or indirectly: controls the Disclosing Party, is controlled by the Disclosing Party, or is, with the Disclosing Party, under common control of another person or entity). Indicia of control include, without limitation: interlocking management or ownership; identity of interests among family members, shared facilities and equipment; common use of employees; or organization of a business entity following the ineligibility of a business entity to do business with federal or state or local government, including the City, using substantially the same management, ownership, or principals as the ineligible entity. With respect to Contractors, the term Affiliated Entity means a person or entity that directly or indirectly controls the Contractor, is controlled by it, or, with the Contractor, is under common control of another person or entity;
 - any responsible official of the Disclosing Party, any Contractor or any Affiliated Entity or any other official, agent or employee of the Disclosing Party, any Contractor or any Affiliated Entity, acting pursuant to the direction or authorization of a responsible official of the Disclosing Party, any Contractor or any Affiliated Entity (collectively "Agents").

Neither the Disclosing Party, nor any Contractor, nor any Affiliated Entity of either the Disclosing Party or any Contractor, nor any Agents have, during the 5 years before the date of this EDS, or, with respect to a Contractor, an Affiliated Entity, or an Affiliated Entity of a Contractor during the 5 years before the date of such Contractor's or Affiliated Entity's contract or engagement in connection with the Matter:

- a. bribed or attempted to bribe, or been convicted or adjudged guilty of bribery or attempting to bribe, a public officer or employee of the City, the State of Illinois, or any agency of the federal government or of any state or local government in the United States of America, in that officer's or employee's official capacity;
 - b. agreed or colluded with other bidders or prospective bidders, or been a party to any such agreement, or been convicted or adjudged guilty of agreement or collusion among bidders or prospective bidders, in restraint of freedom of competition by agreement to bid a fixed price or otherwise; or
 - c. made an admission of such conduct described in subparagraph (a) or (b) above that is a matter of record, but have not been prosecuted for such conduct; or
 - d. violated the provisions referenced in MCC Subsection 2-92-320(a)(4)(Contracts Requiring a Base Wage); (a)(5)(Debarment Regulations); or (a)(6)(Minimum Wage Ordinance).
6. Neither the Disclosing Party, nor any Affiliated Entity or Contractor, or any of their employees, officials, agents or partners, is barred from contracting with any unit of state or local government as a result of engaging in or being convicted of (1) bid-rigging in violation of 720 ILCS 5/33E-3; (2) bid-rotating in violation of 720 ILCS 5/33E-4; or (3) any similar offense of any state or of the United States of America that contains the same elements as the offense of bid-rigging or bid-rotating.
7. Neither the Disclosing Party nor any Affiliated Entity is listed on a Sanctions List maintained by the United States Department of Commerce, State, or Treasury, or any successor federal agency.
8. [FOR APPLICANT ONLY] (i) Neither the Applicant nor any "controlling person" [see MCC Chapter 1-23, Article I for applicability and defined terms] of the Applicant is currently indicted or charged with, or has admitted guilt of, or has ever been convicted of, or placed under supervision for, any criminal offense involving actual, attempted, or conspiracy to commit bribery, theft, fraud, forgery, perjury, dishonesty or deceit against an officer or employee of the City or any "sister agency"; and (ii) the Applicant understands and acknowledges that compliance with Article I is a continuing requirement for doing business with the City. NOTE: If MCC Chapter 1-23, Article I applies to the Applicant, that Article's permanent compliance timeframe supersedes 5-year compliance timeframes in this Section V.
9. [FOR APPLICANT ONLY] The Applicant and its Affiliated Entities will not use, nor permit their subcontractors to use, any facility listed as having an active exclusion by the U.S. EPA on the federal System for Award Management ("SAM").
10. [FOR APPLICANT ONLY] The Applicant will obtain from any contractors/subcontractors hired or to be hired in connection with the Matter certifications equal in form and substance to those in Certifications (2) and (9) above and will not, without the prior written consent of the City, use any such

contractor/subcontractor that does not provide such certifications or that the Applicant has reason to believe has not provided or cannot provide truthful certifications.

11. If the Disclosing Party is unable to certify to any of the above statements in this Part B (Further Certifications), the Disclosing Party must explain below:

N/A

If the letters "NA," the word "None," or no response appears on the lines above, it will be conclusively presumed that the Disclosing Party certified to the above statements.

12. To the best of the Disclosing Party's knowledge after reasonable inquiry, the following is a complete list of all current employees of the Disclosing Party who were, at any time during the 12-month period preceding the date of this EDS, an employee, or elected or appointed official, of the City of Chicago (if none, indicate with "N/A" or "none").

N/A

13. To the best of the Disclosing Party's knowledge after reasonable inquiry, the following is a complete list of all gifts that the Disclosing Party has given or caused to be given, at any time during the 12-month period preceding the execution date of this EDS, to an employee, or elected or appointed official, of the City of Chicago. For purposes of this statement, a "gift" does not include: (i) anything made generally available to City employees or to the general public, or (ii) food or drink provided in the course of official City business and having a retail value of less than \$25 per recipient, or (iii) a political contribution otherwise duly reported as required by law (if none, indicate with "N/A" or "none"). As to any gift listed below, please also list the name of the City recipient.

N/A

C. CERTIFICATION OF STATUS AS FINANCIAL INSTITUTION

1. The Disclosing Party certifies that the Disclosing Party (check one)

is is not

a "financial institution" as defined in MCC Section 2-32-455(b).

2. If the Disclosing Party IS a financial institution, then the Disclosing Party pledges:

"We are not and will not become a predatory lender as defined in MCC Chapter 2-32. We further pledge that none of our affiliates is, and none of them will become, a predatory lender as defined in MCC Chapter 2-32. We understand that becoming a predatory lender or becoming an affiliate of a predatory lender may result in the loss of the privilege of doing business with the City."

If the Disclosing Party is unable to make this pledge because it or any of its affiliates (as defined in MCC Section 2-32-455(b)) is a predatory lender within the meaning of MCC Chapter 2-32, explain here (attach additional pages if necessary):

If the letters "NA," the word "None," or no response appears on the lines above, it will be conclusively presumed that the Disclosing Party certified to the above statements.

D. CERTIFICATION REGARDING FINANCIAL INTEREST IN CITY BUSINESS

Any words or terms defined in MCC Chapter 2-156 have the same meanings if used in this Part D.

1. In accordance with MCC Section 2-156-110: To the best of the Disclosing Party's knowledge after reasonable inquiry, does any official or employee of the City have a financial interest in his or her own name or in the name of any other person or entity in the Matter?

Yes

No

NOTE: If you checked "Yes" to Item D(1), proceed to Items D(2) and D(3). If you checked "No" to Item D(1), skip Items D(2) and D(3) and proceed to Part E.

2. Unless sold pursuant to a process of competitive bidding, or otherwise permitted, no City elected official or employee shall have a financial interest in his or her own name or in the name of any other person or entity in the purchase of any property that (i) belongs to the City, or (ii) is sold for taxes or assessments, or (iii) is sold by virtue of legal process at the suit of the City (collectively, "City Property Sale"). Compensation for property taken pursuant to the City's eminent domain power does not constitute a financial interest within the meaning of this Part D.

Does the Matter involve a City Property Sale?

Yes

No

3. If you checked "Yes" to Item D(1), provide the names and business addresses of the City officials or employees having such financial interest and identify the nature of the financial interest:

Name	Business Address	Nature of Financial Interest
------	------------------	------------------------------

4. The Disclosing Party further certifies that no prohibited financial interest in the Matter will be acquired by any City official or employee.

E. CERTIFICATION REGARDING SLAVERY ERA BUSINESS

Please check either (1) or (2) below. If the Disclosing Party checks (2), the Disclosing Party must disclose below or in an attachment to this EDS all information required by (2). Failure to comply with these disclosure requirements may make any contract entered into with the City in connection with the Matter voidable by the City.

X 1. The Disclosing Party verifies that the Disclosing Party has searched any and all records of the Disclosing Party and any and all predecessor entities regarding records of investments or profits from slavery or slaveholder insurance policies during the slavery era (including insurance policies issued to slaveholders that provided coverage for damage to or injury or death of their slaves), and the Disclosing Party has found no such records.

2. The Disclosing Party verifies that, as a result of conducting the search in step (1) above, the Disclosing Party has found records of investments or profits from slavery or slaveholder insurance policies. The Disclosing Party verifies that the following constitutes full disclosure of all such records, including the names of any and all slaves or slaveholders described in those records:

SECTION VI -- CERTIFICATIONS FOR FEDERALLY FUNDED MATTERS

NOTE: If the Matter is federally funded, complete this Section VI. If the Matter is not federally funded, proceed to Section VII. For purposes of this Section VI, tax credits allocated by the City and proceeds of debt obligations of the City are not federal funding.

A. CERTIFICATION REGARDING LOBBYING

1. List below the names of all persons or entities registered under the federal Lobbying Disclosure Act of 1995, as amended, who have made lobbying contacts on behalf of the Disclosing Party with respect to the Matter: (Add sheets if necessary):

(If no explanation appears or begins on the lines above, or if the letters "NA" or if the word "None" appear, it will be conclusively presumed that the Disclosing Party means that NO persons or entities registered under the Lobbying Disclosure Act of 1995, as amended, have made lobbying contacts on behalf of the Disclosing Party with respect to the Matter.)

2. The Disclosing Party has not spent and will not expend any federally appropriated funds to pay any person or entity listed in paragraph A(1) above for his or her lobbying activities or to pay any person or entity to influence or attempt to influence an officer or employee of any agency, as defined by applicable federal law, a member of Congress, an officer or employee of Congress, or an employee

of a member of Congress, in connection with the award of any federally funded contract, making any federally funded grant or loan, entering into any cooperative agreement, or to extend, continue, renew, amend, or modify any federally funded contract, grant, loan, or cooperative agreement.

3. The Disclosing Party will submit an updated certification at the end of each calendar quarter in which there occurs any event that materially affects the accuracy of the statements and information set forth in paragraphs A(1) and A(2) above.

4. The Disclosing Party certifies that either: (i) it is not an organization described in section 501(c)(4) of the Internal Revenue Code of 1986; or (ii) it is an organization described in section 501(c)(4) of the Internal Revenue Code of 1986 but has not engaged and will not engage in "Lobbying Activities," as that term is defined in the Lobbying Disclosure Act of 1995, as amended.

5. If the Disclosing Party is the Applicant, the Disclosing Party must obtain certifications equal in form and substance to paragraphs A(1) through A(4) above from all subcontractors before it awards any subcontract and the Disclosing Party must maintain all such subcontractors' certifications for the duration of the Matter and must make such certifications promptly available to the City upon request.

B. CERTIFICATION REGARDING EQUAL EMPLOYMENT OPPORTUNITY

If the Matter is federally funded, federal regulations require the Applicant and all proposed subcontractors to submit the following information with their bids or in writing at the outset of negotiations.

Is the Disclosing Party the Applicant?

Yes

No

If "Yes," answer the three questions below:

1. Have you developed and do you have on file affirmative action programs pursuant to applicable federal regulations? (See 41 CFR Part 60-2.)

Yes

No

2. Have you filed with the Joint Reporting Committee, the Director of the Office of Federal Contract Compliance Programs, or the Equal Employment Opportunity Commission all reports due under the applicable filing requirements?

Yes

No

Reports not required

3. Have you participated in any previous contracts or subcontracts subject to the equal opportunity clause?

Yes

No

If you checked "No" to question (1) or (2) above, please provide an explanation:

SECTION VII -- FURTHER ACKNOWLEDGMENTS AND CERTIFICATION

The Disclosing Party understands and agrees that:

A. The certifications, disclosures, and acknowledgments contained in this EDS will become part of any contract or other agreement between the Applicant and the City in connection with the Matter, whether procurement, City assistance, or other City action, and are material inducements to the City's execution of any contract or taking other action with respect to the Matter. The Disclosing Party understands that it must comply with all statutes, ordinances, and regulations on which this EDS is based.

B. The City's Governmental Ethics Ordinance, MCC Chapter 2-156, imposes certain duties and obligations on persons or entities seeking City contracts, work, business, or transactions. The full text of this ordinance and a training program is available on line at www.cityofchicago.org/Ethics, and may also be obtained from the City's Board of Ethics, 740 N. Sedgwick St., Suite 500, Chicago, IL 60610, (312) 744-9660. The Disclosing Party must comply fully with this ordinance.

C. If the City determines that any information provided in this EDS is false, incomplete or inaccurate, any contract or other agreement in connection with which it is submitted may be rescinded or be void or voidable, and the City may pursue any remedies under the contract or agreement (if not rescinded or void), at law, or in equity, including terminating the Disclosing Party's participation in the Matter and/or declining to allow the Disclosing Party to participate in other City transactions. Remedies at law for a false statement of material fact may include incarceration and an award to the City of treble damages.

D. It is the City's policy to make this document available to the public on its Internet site and/or upon request. Some or all of the information provided in, and appended to, this EDS may be made publicly available on the Internet, in response to a Freedom of Information Act request, or otherwise. By completing and signing this EDS, the Disclosing Party waives and releases any possible rights or claims which it may have against the City in connection with the public release of information contained in this EDS and also authorizes the City to verify the accuracy of any information submitted in this EDS.

E. The information provided in this EDS must be kept current. In the event of changes, the Disclosing Party must supplement this EDS up to the time the City takes action on the Matter. If the Matter is a contract being handled by the City's Department of Procurement Services, the Disclosing Party must update this EDS as the contract requires. **NOTE:** With respect to Matters subject to MCC Chapter 1-23, Article I (imposing **PERMANENT INELIGIBILITY** for certain specified offenses), the information provided herein regarding eligibility must be kept current for a longer period, as required by MCC Chapter 1-23 and Section 2-154-020.

CERTIFICATION

Under penalty of perjury, the person signing below: (1) warrants that he/she is authorized to execute this EDS, and all applicable Appendices, on behalf of the Disclosing Party, and (2) warrants that all certifications and statements contained in this EDS, and all applicable Appendices, are true, accurate and complete as of the date furnished to the City.

Ringgold Capital IV, LLC
(Print or type exact legal name of Disclosing Party)

By: Robert Fedoris
(Sign here)

Robert Fedoris
(Print or type name of person signing)

Member/Manager
(Print or type title of person signing)

Signed and sworn to before me on (date) September 9th, 2019,

at Cook County, Illinois (state).

Brooke H Schlichtman
Notary Public

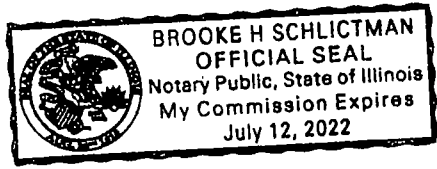

Commission expires: July 12, 2022

**CITY OF CHICAGO
ECONOMIC DISCLOSURE STATEMENT AND AFFIDAVIT
APPENDIX A**

**FAMILIAL RELATIONSHIPS WITH ELECTED CITY OFFICIALS
AND DEPARTMENT HEADS**

This Appendix is to be completed only by (a) the Applicant, and (b) any legal entity which has a direct ownership interest in the Applicant exceeding 7.5%. It is not to be completed by any legal entity which has only an indirect ownership interest in the Applicant.

Under MCC Section 2-154-015, the Disclosing Party must disclose whether such Disclosing Party or any "Applicable Party" or any Spouse or Domestic Partner thereof currently has a "familial relationship" with any elected city official or department head. A "familial relationship" exists if, as of the date this EDS is signed, the Disclosing Party or any "Applicable Party" or any Spouse or Domestic Partner thereof is related to the mayor, any alderman, the city clerk, the city treasurer or any city department head as spouse or domestic partner or as any of the following, whether by blood or adoption: parent, child, brother or sister, aunt or uncle, niece or nephew, grandparent, grandchild, father-in-law, mother-in-law, son-in-law, daughter-in-law, stepfather or stepmother, stepson or stepdaughter, stepbrother or stepsister or half-brother or half-sister.

"Applicable Party" means (1) all executive officers of the Disclosing Party listed in Section II.B.1.a., if the Disclosing Party is a corporation; all partners of the Disclosing Party, if the Disclosing Party is a general partnership; all general partners and limited partners of the Disclosing Party, if the Disclosing Party is a limited partnership; all managers, managing members and members of the Disclosing Party, if the Disclosing Party is a limited liability company; (2) all principal officers of the Disclosing Party; and (3) any person having more than a 7.5% ownership interest in the Disclosing Party. "Principal officers" means the president, chief operating officer, executive director, chief financial officer, treasurer or secretary of a legal entity or any person exercising similar authority.

Does the Disclosing Party or any "Applicable Party" or any Spouse or Domestic Partner thereof currently have a "familial relationship" with an elected city official or department head?

Yes

No

If yes, please identify below (1) the name and title of such person, (2) the name of the legal entity to which such person is connected; (3) the name and title of the elected city official or department head to whom such person has a familial relationship, and (4) the precise nature of such familial relationship.

**CITY OF CHICAGO
ECONOMIC DISCLOSURE STATEMENT AND AFFIDAVIT
APPENDIX B**

BUILDING CODE SCOFFLAW/PROBLEM LANDLORD CERTIFICATION

This Appendix is to be completed only by (a) the Applicant, and (b) any legal entity which has a direct ownership interest in the Applicant exceeding 7.5% (an "Owner"). It is not to be completed by any legal entity which has only an indirect ownership interest in the Applicant.

1. Pursuant to MCC Section 2-154-010, is the Applicant or any Owner identified as a building code scofflaw or problem landlord pursuant to MCC Section 2-92-416?

Yes No

2. If the Applicant is a legal entity publicly traded on any exchange, is any officer or director of the Applicant identified as a building code scofflaw or problem landlord pursuant to MCC Section 2-92-416?

Yes No The Applicant is not publicly traded on any exchange.

3. If yes to (1) or (2) above, please identify below the name of each person or legal entity identified as a building code scofflaw or problem landlord and the address of each building or buildings to which the pertinent code violations apply.

**CITY OF CHICAGO
ECONOMIC DISCLOSURE STATEMENT AND AFFIDAVIT
APPENDIX C**

PROHIBITION ON WAGE & SALARY HISTORY SCREENING - CERTIFICATION

This Appendix is to be completed only by an Applicant that is completing this EDS as a “contractor” as defined in MCC Section 2-92-385. That section, which should be consulted (www.amlegal.com), generally covers a party to any agreement pursuant to which they: (i) receive City of Chicago funds in consideration for services, work or goods provided (including for legal or other professional services), or (ii) pay the City money for a license, grant or concession allowing them to conduct a business on City premises.

On behalf of an Applicant that is a contractor pursuant to MCC Section 2-92-385, I hereby certify that the Applicant is in compliance with MCC Section 2-92-385(b)(1) and (2), which prohibit: (i) screening job applicants based on their wage or salary history, or (ii) seeking job applicants’ wage or salary history from current or former employers. I also certify that the Applicant has adopted a policy that includes those prohibitions.

Yes

No

N/A – I am not an Applicant that is a “contractor” as defined in MCC Section 2-92-385.

This certification shall serve as the affidavit required by MCC Section 2-92-385(c)(1).

If you checked “no” to the above, please explain.
